

Relay <b>5</b>	Lane <b>4</b>	<b>Niels Dalhoff Andersen</b>	
Day 1 Denmark Open Air		Karlsunde Skytteforening	Mp
08.03.2019		Day 1 Denmark Open Air	Denmark Open Air
Serie 1		1: 10.0 ↓ 2: 10.9x ↓ 3: 9.3 → 4: 8.8 ↗ 5: 9.9 ↓ 6: 9.3 ↓ 7: 6.8 → 8: 9.7 ↑ 9: 9.3 ↗ 10: 9.9 ↑ Series 88 ( 1x) 88 ( 1x)	Serie 2 1: 9.9 ↖ 2: 9.6 ↓ 3: 8.2 → 4: 10.2 → 5: 8.1 ← 6: 5.9 ↗ 7: 10.3 ↗ 8: 10.3 ↓ 9: 10.2 ↓ 10: 8.2 ↖ Series 87 ( 0x) 175 ( 1x)
Serie 3		1: 10.6x ← 2: 8.1 ↓ 3: 8.7 → 4: 8.4 ↗ 5: 10.3 ↓ 6: 9.2 → 7: 8.4 ↓ 8: 9.0 ↗ 9: 9.6 ↑ 10: 9.9 ↗ Series 88 ( 1x) 263 ( 2x)	Serie 4 1: 9.1 ↗ 2: 10.6x ↖ 3: 9.4 ↑ 4: 10.0 ↑ 5: 8.8 → 6: 5.3 ↗ 7: 10.0 ↑ 8: 8.8 ← 9: 9.9 ↑ 10: 9.3 ← Series 87 ( 1x) 350 ( 3x)
Serie 5		1: 10.7x ↖ 2: 9.1 ← 3: 9.7 ↓ 4: 9.5 ↑ 5: 9.1 ← 6: 9.7 ↓ 7: 9.5 ↓ 8: 10.3 ← 9: 10.3 ↓ 10: 9.1 → Series 93 ( 1x) 443 ( 4x)	Serie 6 1: 8.8 ↑ 2: 10.5x ↓ 3: 8.5 → 4: 10.2 ↓ 5: 9.4 ↓ 6: 10.0 → 7: 9.6 ↗ 8: 10.2 ↑ 9: 10.0 ← 10: 10.8x ← Series 94 ( 2x) 537 ( 6x)

<p><b>Serie 1</b></p> 	<p>1: 9.9 ↑</p> <p>2: 10.5x ➤</p> <p>3: 10.0 ↗</p> <p>4: 10.7x ➤</p> <p>5: 10.2 ↘</p> <p>6: 10.1 ➔</p> <p>7: 10.2 ←</p> <p>8: 9.9 ↘</p> <p>9: 10.6x ↑</p> <p>10: 10.6x ↖</p> <p><b>Series 98 (4x)</b></p> <p>98 (4x)</p>	<p><b>Serie 2</b></p> 	<p>1: 10.2 ↗</p> <p>2: 10.0 ←</p> <p>3: 9.8 ↘</p> <p>4: 10.3 ↘</p> <p>5: 8.8 ↘</p> <p>6: 9.3 ←</p> <p>7: 10.5x ↑</p> <p>8: 9.9 ←</p> <p>9: 10.7x ↑</p> <p>10: 9.9 ➔</p> <p><b>Series 94 (2x)</b></p> <p>192 (6x)</p>
--	--	--	--

<p><b>Serie 3</b></p> 	<p>1: 10.5x ↓</p> <p>2: 9.9 ←</p> <p>3: 9.9 ←</p> <p>4: 9.9 ←</p> <p>5: 10.2 ↓</p> <p>6: 9.6 ↘</p> <p>7: 9.6 ➔</p> <p>8: 10.0 ←</p> <p>9: 10.5x ↙</p> <p>10: 10.1 ↙</p> <p><b>Series 95 (2x)</b></p> <p>287 (8x)</p>	<p><b>Serie 4</b></p> 	<p>1: 9.4 ↑</p> <p>2: 9.5 ↗</p> <p>3: 10.3 ➤</p> <p>4: 9.4 ➤</p> <p>5: 9.4 ↑</p> <p>6: 9.8 ←</p> <p>7: 9.6 ↘</p> <p>8: 10.2 ↘</p> <p>9: 10.8x ↙</p> <p>10: 10.0 ↖</p> <p><b>Series 94 (1x)</b></p> <p>381 (9x)</p>
---	--	---	--

<p><b>Serie 5</b></p> 	<p>1: 10.2 ↘</p> <p>2: 10.6x ➤</p> <p>3: 10.6x ↑</p> <p>4: 9.7 ↘</p> <p>5: 10.6x ↗</p> <p>6: 9.8 ↘</p> <p>7: 10.1 ↓</p> <p>8: 9.8 ↘</p> <p>9: 10.8x ↘</p> <p>10: 9.8 ↓</p> <p><b>Series 96 (4x)</b></p> <p>477 (13x)</p>	<p><b>Serie 6</b></p> 	<p>1: 10.4x ↖</p> <p>2: 8.0 ↘</p> <p>3: 10.2 ➤</p> <p>4: 9.6 ↘</p> <p>5: 10.8x ↙</p> <p>6: 10.1 ↑</p> <p>7: 10.1 ←</p> <p>8: 10.3 ↑</p> <p>9: 10.1 ↑</p> <p>10: 10.4x ↘</p> <p><b>Series 97 (3x)</b></p> <p>574 (16x)</p>
--	--	--	---

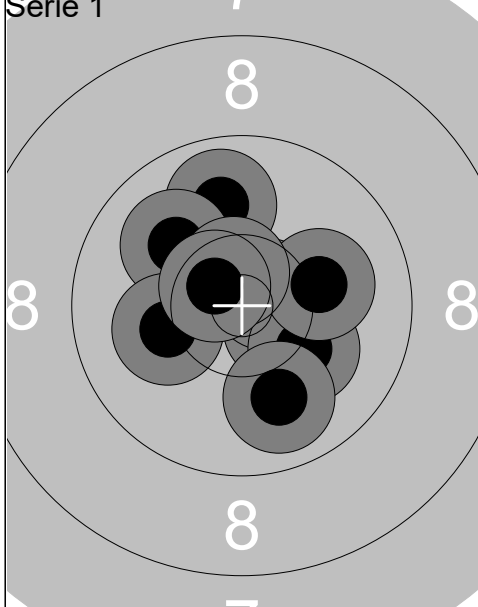
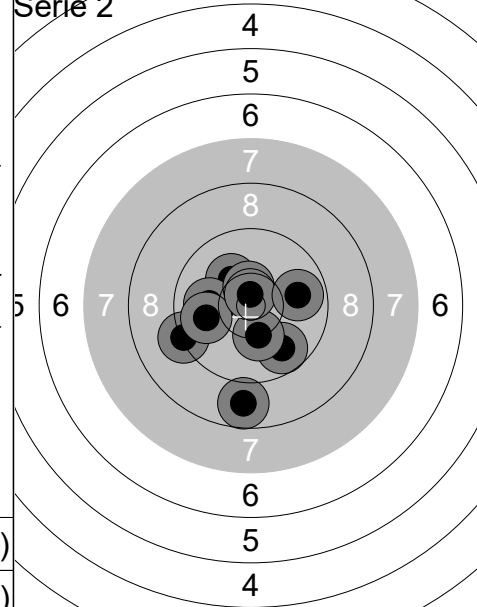
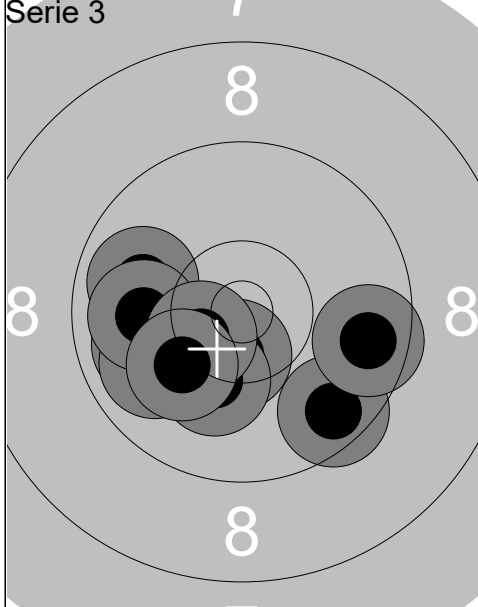
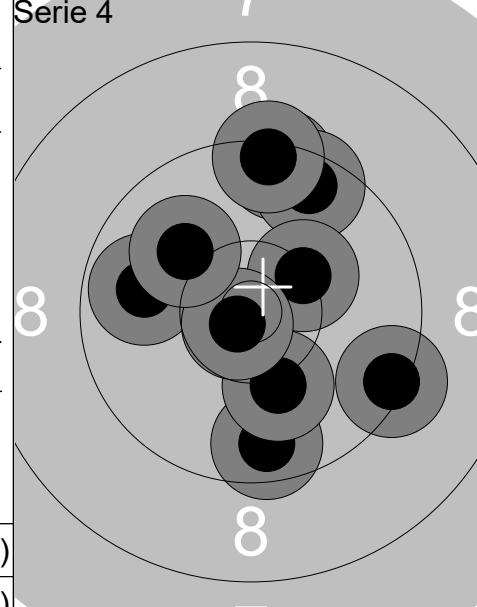
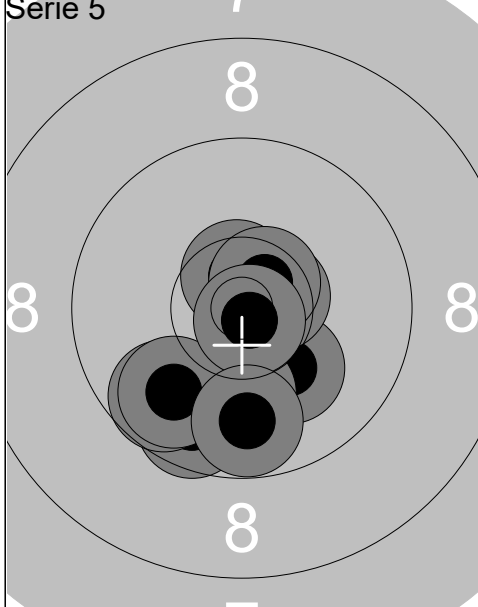
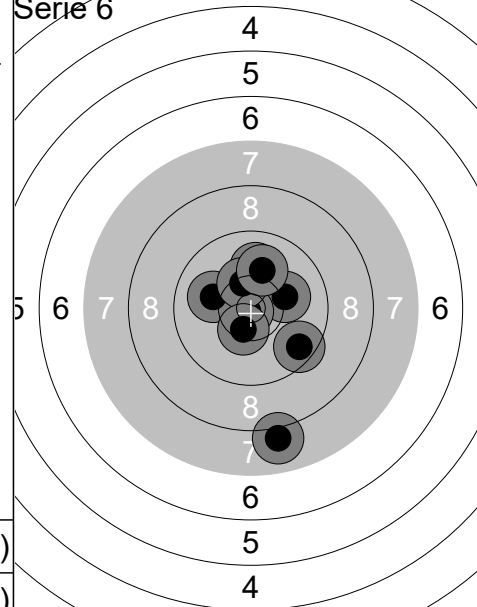
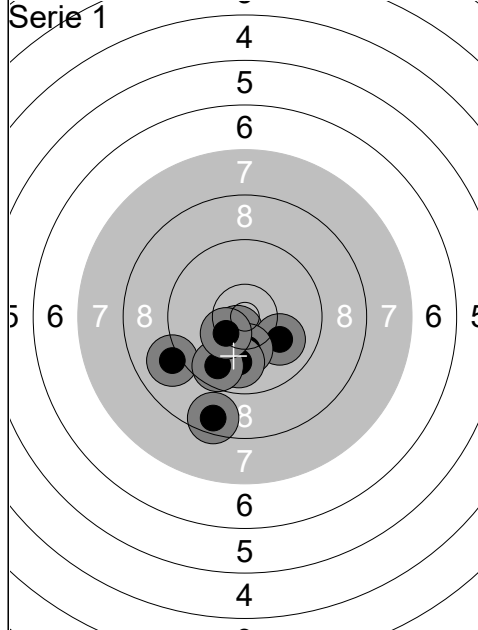

1:	10.6x ↘
2:	9.8 ↘
3:	8.6 ↘
4:	9.1 ↙
5:	10.3 ↘
6:	10.0 ➡
7:	10.2 ↓
8:	9.9 ↓
9:	9.7 ↘
10:	10.4x ↙
<b>Series</b>	<b>94 ( 2x)</b>
	<b>94 ( 2x)</b>

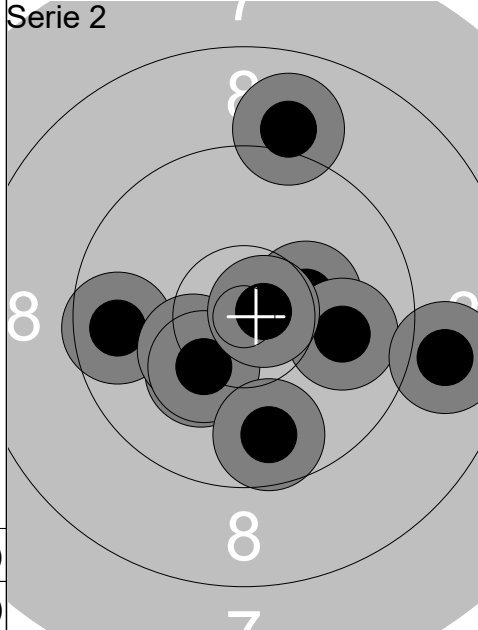

1:	9.7 ←
2:	10.2 ↘
3:	10.3 ↙
4:	9.0 ↑
5:	10.3 ➡
6:	9.9 ➡
7:	10.3 ↘
8:	10.7x ➡
9:	8.9 ➡
10:	9.7 ↓
<b>Series</b>	<b>94 ( 1x)</b>
	<b>188 ( 3x)</b>

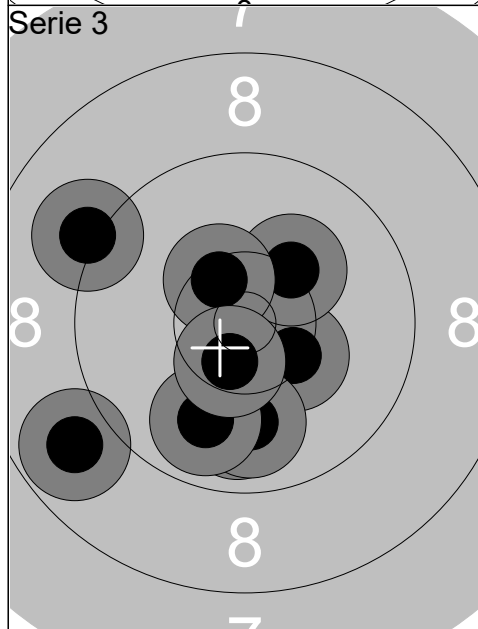

1:	10.8x ↑
2:	10.4x ➡
3:	9.9 ↓
4:	9.9 ↓
5:	10.2 ↗
6:	9.1 ↙
7:	8.8 ↙
8:	10.4x ↗
9:	9.9 ↓
10:	10.5x ↓
<b>Series</b>	<b>94 ( 4x)</b>
	<b>282 ( 7x)</b>

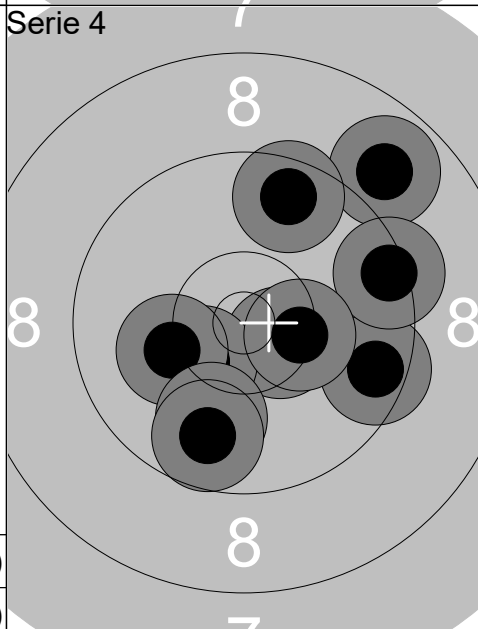

1:	10.5x ➡
2:	10.4x ↙
3:	9.5 ➡
4:	10.2 ↙
5:	8.9 ↗
6:	9.4 ➡
7:	9.6 ↑
8:	10.4x ➡
9:	9.9 ↓
10:	9.8 ↓
<b>Series</b>	<b>93 ( 3x)</b>
	<b>375 (10x)</b>

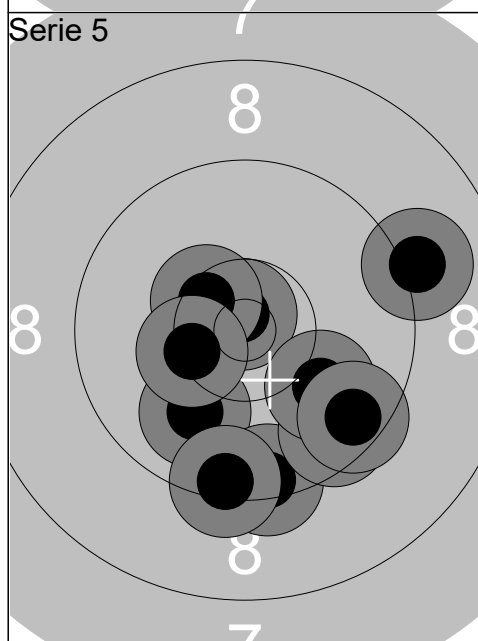

1:	10.8x ↑
2:	10.0 ↘
3:	9.1 ➡
4:	9.4 ↓
5:	9.6 ↘
6:	10.0 ↘
7:	10.5x ↗
8:	9.5 ↘
9:	10.4x ↙
10:	9.4 ↓
<b>Series</b>	<b>95 ( 3x)</b>
	<b>470 (13x)</b>

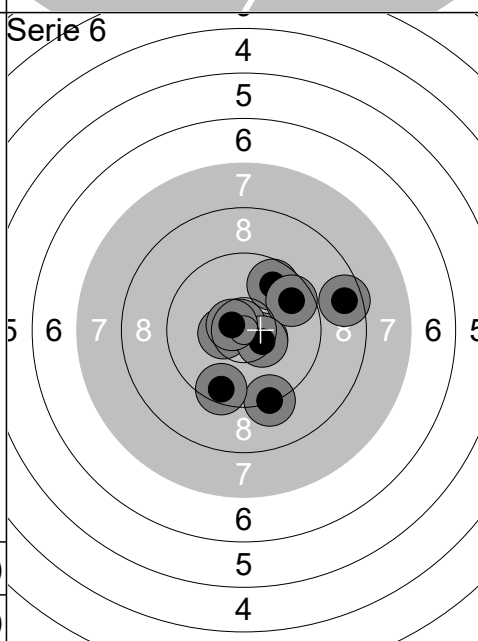

1:	10.5x ➡
2:	9.7 ↗
3:	9.3 ↓
4:	9.7 ➡
5:	9.5 ↓
6:	10.5x ↙
7:	10.8x ↗
8:	10.5x ➡
9:	10.6x ↙
10:	8.6 ➡
<b>Series</b>	<b>94 ( 5x)</b>
	<b>564 (18x)</b>

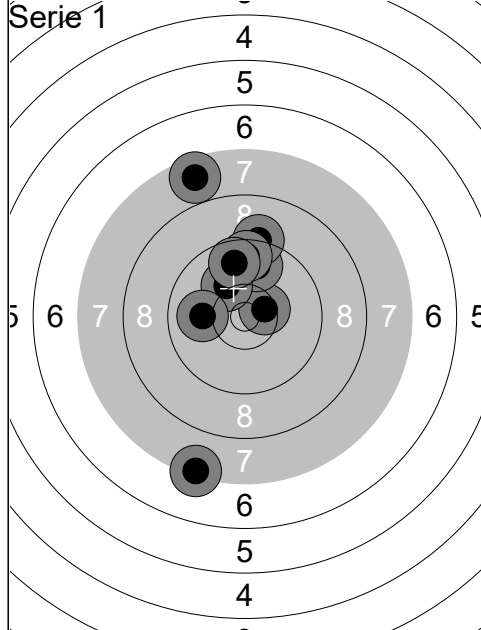

1:	10.0	↑
2:	10.5x	→
3:	9.8	↑
4:	7.6	↑
5:	9.2	↑
6:	10.1	↖
7:	10.0	←
8:	7.3	↓
9:	9.6	↑
10:	9.7	↑
<b>Series</b>	<b>90 ( 1x)</b>	
	<b>90 ( 1x)</b>	

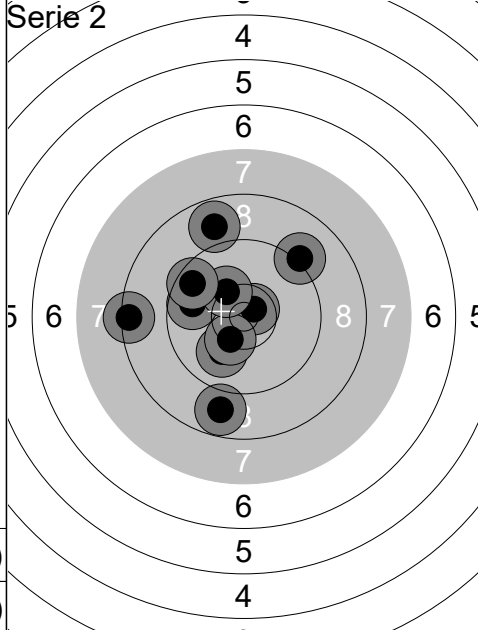

1:	9.2	↗
2:	10.7x	↗
3:	10.0	↘
4:	10.4	↘
5:	8.8	↑
6:	9.8	←
7:	8.8	↓
8:	10.3	↗
9:	9.6	↖
10:	8.4	←
<b>Series</b>	<b>91 ( 1x)</b>	
	<b>181 ( 2x)</b>	

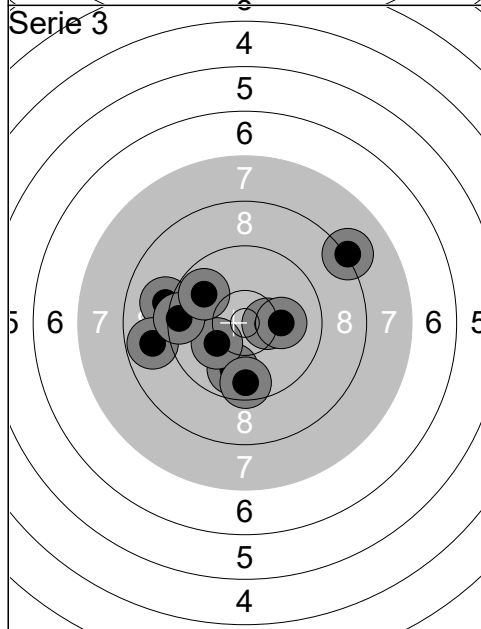

1:	9.9	↓
2:	9.1	←
3:	8.2	↗
4:	10.4x	→
5:	10.2	↖
6:	9.6	↓
7:	8.8	←
8:	9.5	←
9:	10.1	→
10:	9.8	↖
<b>Series</b>	<b>91 ( 1x)</b>	
	<b>272 ( 3x)</b>	

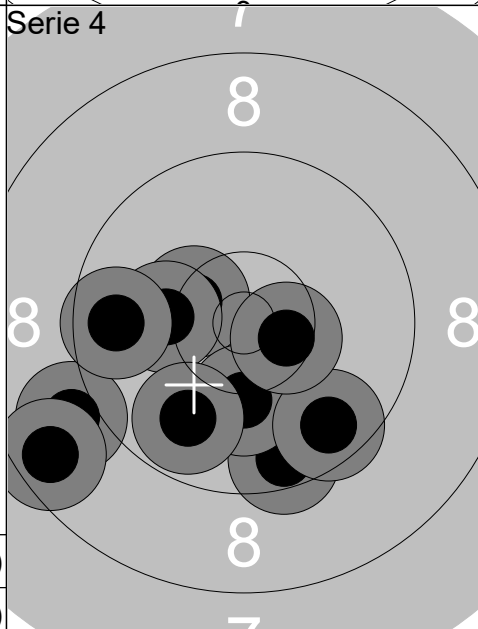

1:	10.4x	↖
2:	9.0	↖
3:	10.2	←
4:	9.5	↓
5:	10.2	↓
6:	9.6	↘
7:	10.5x	→
8:	9.7	←
9:	9.8	↓
10:	8.6	↖
<b>Series</b>	<b>93 ( 2x)</b>	
	<b>365 ( 5x)</b>	

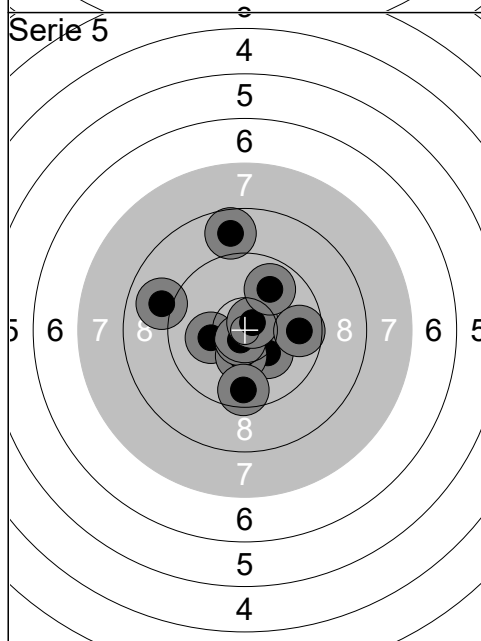

1:	10.2	↘
2:	9.0	←
3:	10.2	←
4:	10.4x	↓
5:	10.7x	↘
6:	10.7x	↗
7:	8.8	↑
8:	9.6	↓
9:	9.9	↗
10:	9.7	→
<b>Series</b>	<b>94 ( 3x)</b>	
	<b>459 ( 8x)</b>	

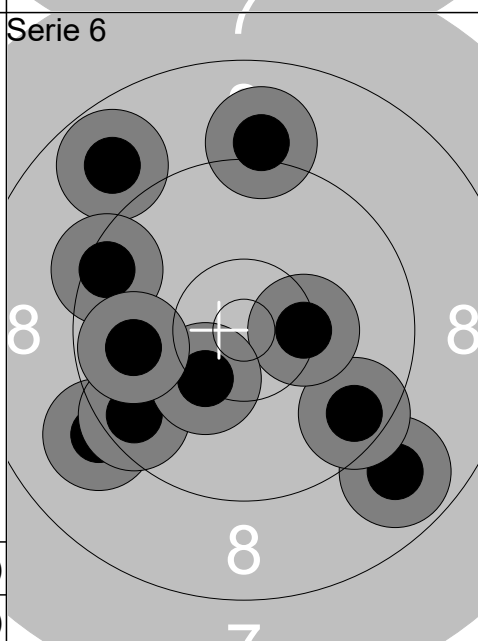

1:	8.9	↘
2:	9.1	↖
3:	9.1	↑
4:	9.6	↘
5:	9.5	↖
6:	10.3	→
7:	8.8	↗
8:	9.4	←
9:	10.3	↘
10:	9.8	←
<b>Series</b>	<b>90 ( 0x)</b>	
	<b>549 ( 8x)</b>	

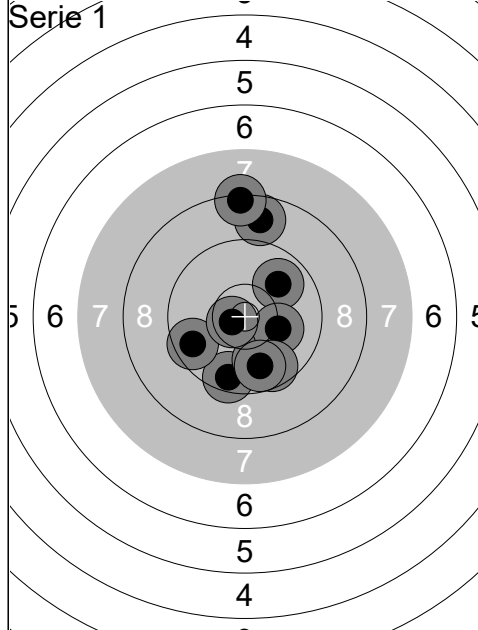

1:	9.6	↓
2:	8.8	↑
3:	9.6	←
4:	9.9	↗
5:	9.9	↓
6:	10.2	→
7:	9.7	↓
8:	10.6x	←
9:	9.8	↓
10:	8.4	↑
<b>Series</b>	<b>90 ( 1x)</b>	
	<b>90 ( 1x)</b>	

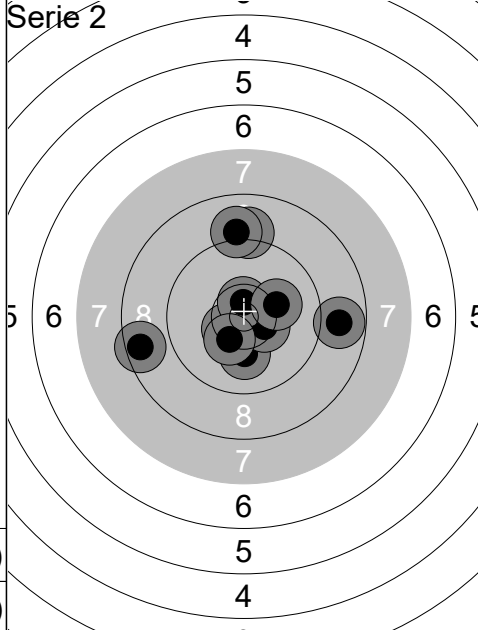

1:	10.5x	↙
2:	10.1	↓
3:	9.1	↑
4:	8.5	←
5:	10.4x	→
6:	8.8	→
7:	10.6x	↑
8:	9.1	↑
9:	10.3	↙
10:	10.2	→
<b>Series</b>	<b>94 ( 3x)</b>	
	<b>184 ( 4x)</b>	

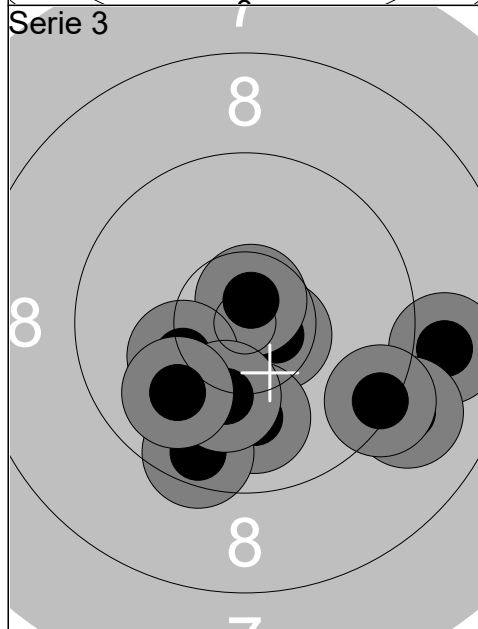

1:	10.6x	→
2:	10.0	↓
3:	9.6	↓
4:	10.7x	↑
5:	10.2	←
6:	8.9	→
7:	10.2	↓
8:	9.1	→
9:	10.0	↙
10:	9.4	→
<b>Series</b>	<b>95 ( 2x)</b>	
	<b>279 ( 6x)</b>	

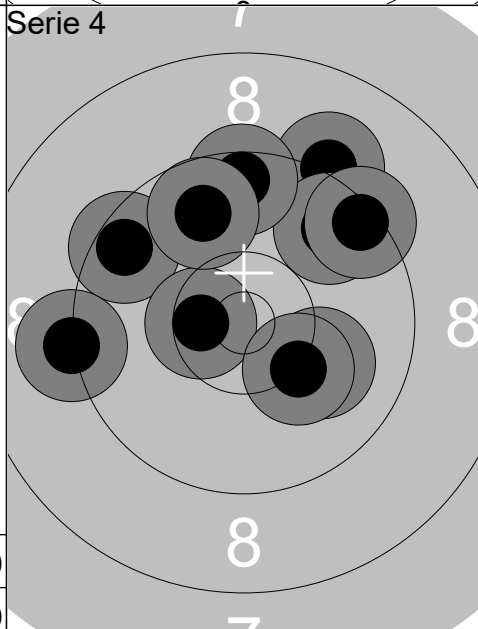

1:	9.5	↖
2:	9.2	↗
3:	10.5x	←
4:	9.7	↗
5:	9.5	↑
6:	10.1	→
7:	10.2	↘
8:	9.2	←
9:	9.8	↑
10:	9.4	↗
<b>Series</b>	<b>93 ( 1x)</b>	
	<b>372 ( 7x)</b>	

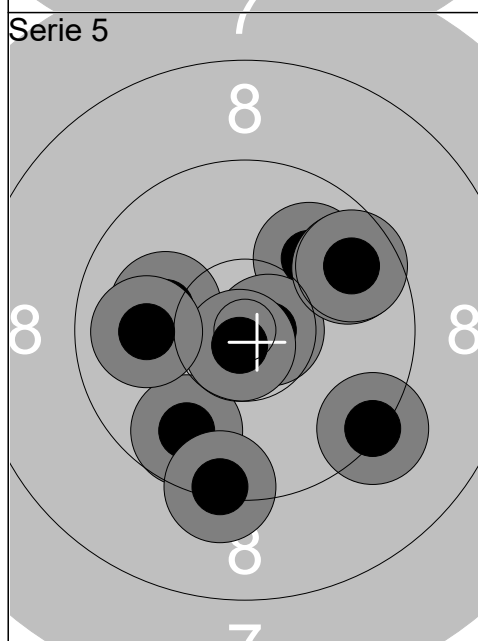

1:	10.0	↗
2:	9.8	↙
3:	9.3	↓
4:	10.7x	→
5:	10.1	←
6:	10.8x	↓
7:	9.7	↗
8:	10.0	←
9:	9.3	↘
10:	9.7	↗
<b>Series</b>	<b>95 ( 2x)</b>	
	<b>467 ( 9x)</b>	

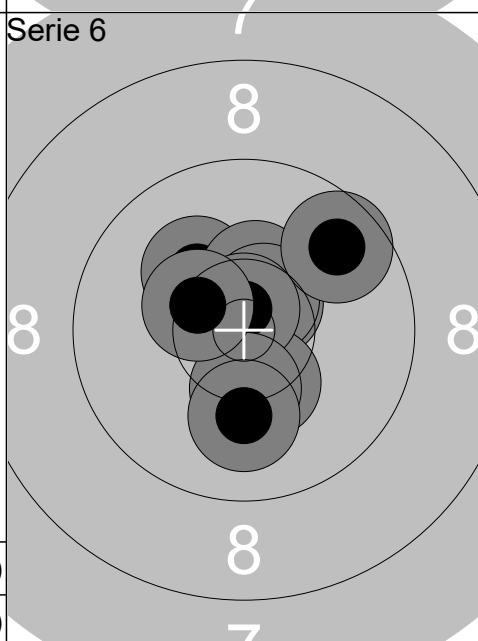

1:	10.2	↖
2:	10.6x	↗
3:	10.4x	↑
4:	10.6x	↗
5:	9.7	↗
6:	10.4x	↓
7:	10.7x	↑
8:	10.4x	↓
9:	10.1	↓
10:	10.4x	↖
<b>Series</b>	<b>99 ( 7x)</b>	
	<b>566 ( 16x)</b>	

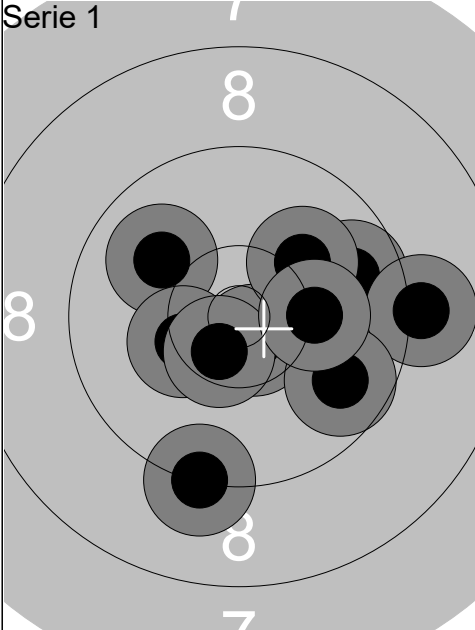
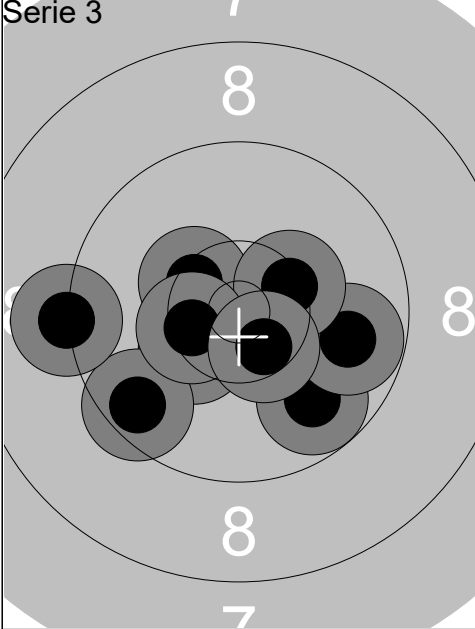
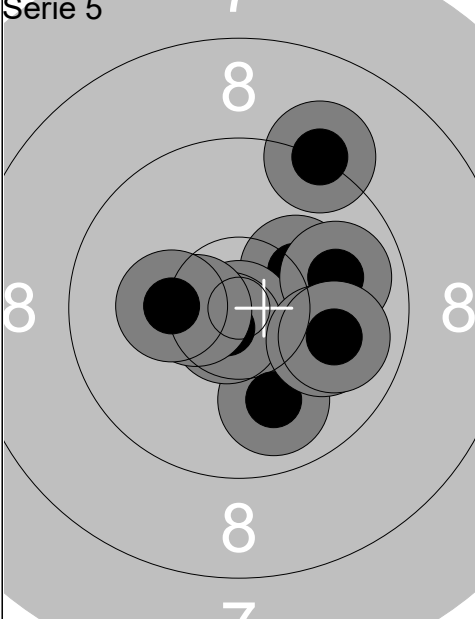
Relay	Lane	Jonas Kofoed Hansen		
5	10			
Day 1 Denmark Open Air	Vejle Skytteforening	Mp		
08.03.2019	Day 1 Denmark Open Air	Denmark Open Air		
Serie 1		1: 10.7x ↘ 2: 10.0 ↖ 3: 9.7 → 4: 9.1 → 5: 10.1 ↗ 6: 10.3 ← 7: 10.5x ↘ 8: 9.7 ↘ 9: 10.2 → 10: 9.2 ↓ Series 96 ( 2x) 96 ( 2x)	Serie 2	1: 10.3 ↓ 2: 9.7 ← 3: 10.4x ↓ 4: 8.8 ↙ 5: 10.1 ↖ 6: 10.4x ↗ 7: 10.3 ↙ 8: 9.2 ↗ 9: 9.3 ↓ 10: 9.7 ↓ Series 94 ( 2x) 190 ( 4x)
Serie 3		1: 10.6x ↗ 2: 10.4x ↙ 3: 9.6 ↙ 4: 9.8 ↘ 5: 9.8 → 6: 9.2 ← 7: 10.4x ↖ 8: 10.4x ↗ 9: 10.4x ← 10: 10.5x ↘ Series 96 ( 6x) 286 (10x)	Serie 4	1: 10.0 → 2: 10.0 ↓ 3: 9.7 → 4: 10.3 ↖ 5: 10.6x ↙ 6: 10.6x ↗ 7: 10.2 ↖ 8: 9.5 ↑ 9: 9.9 ← 10: 10.7x ↙ Series 97 ( 3x) 383 (13x)
Serie 5		1: 10.3 ↗ 2: 10.9x ↓ 3: 10.0 ↓ 4: 9.9 → 5: 9.2 ↗ 6: 10.7x ↘ 7: 10.5x ← 8: 10.3 ← 9: 10.0 → 10: 9.9 → Series 97 ( 3x) 480 (16x)	Serie 6	1: 9.6 ↖ 2: 10.0 ← 3: 9.4 ↑ 4: 9.9 ↖ 5: 9.8 ↑ 6: 10.5x ↘ 7: 9.9 → 8: 10.5x ↓ 9: 10.2 → 10: 8.8 ↙ Series 93 ( 2x) 573 (18x)

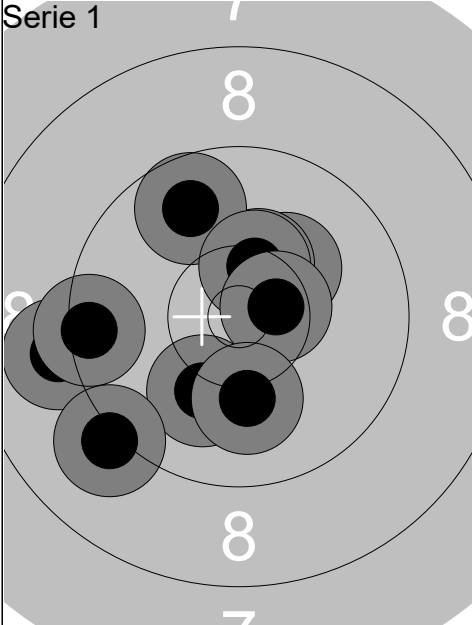
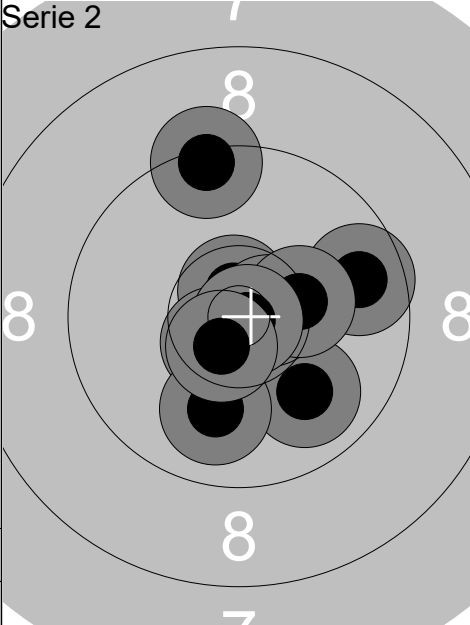
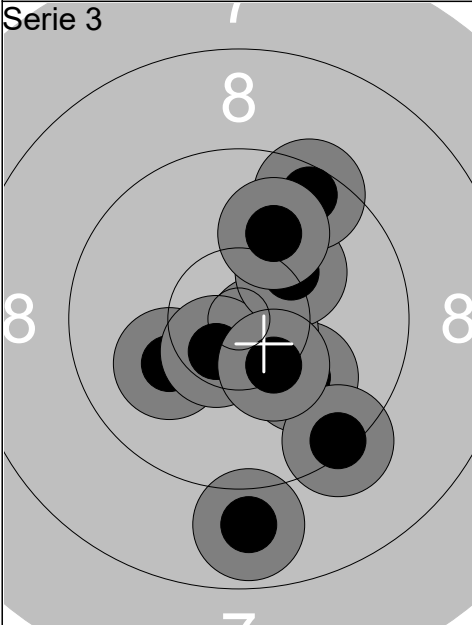
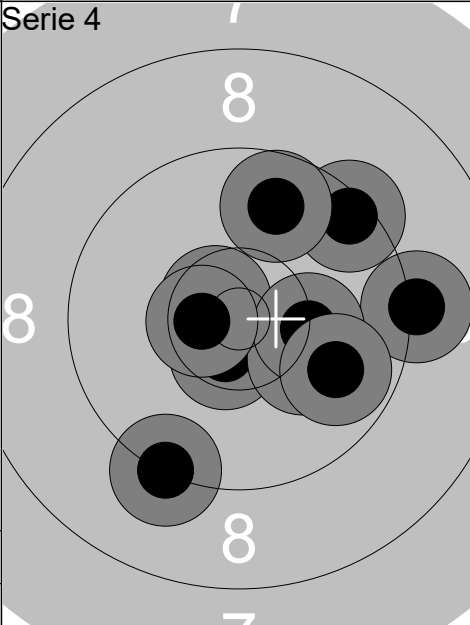
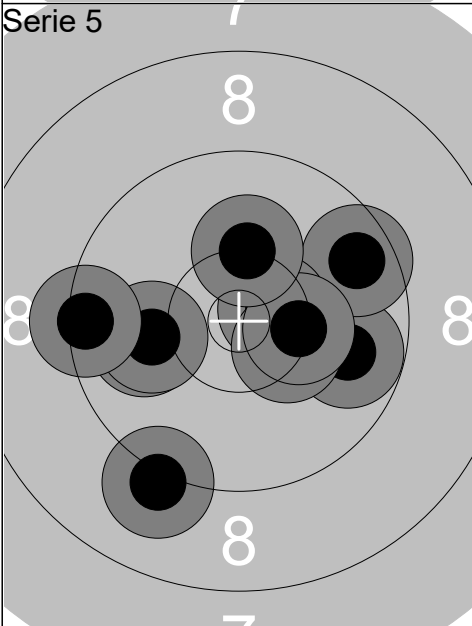
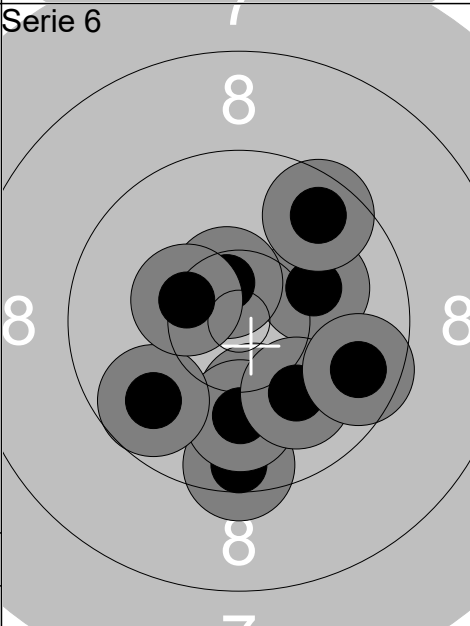
Relay	Lane	Participant	
5	11	Marcus Errebo	
Day 1 Denmark Open Air		Maribo Skytteforening	Mp
08.03.2019		Day 1 Denmark Open Air	Denmark Open Air
Serie 1 	1: 10.3 ↗	Serie 2 	1: 9.4 ↑
	2: 10.4x ↑		2: 9.9 ↘
	3: 9.1 ←		3: 9.7 →
	4: 9.8 ↗		4: 10.7x ↑
	5: 10.4x ↑		5: 10.6x ↘
	6: 10.6x →		6: 10.0 ↓
	7: 10.1 ↓		7: 10.6x →
	8: 9.4 ←		8: 10.3 →
	9: 9.1 ↘		9: 10.8x →
	10: 10.1 ↓		10: 10.6x ↘
	Series 96 ( 3x)		Series 97 ( 5x)
	96 ( 3x)		193 ( 8x)
Serie 3 	1: 10.1 ↘	Serie 4 	1: 9.2 →
	2: 9.4 ↘		2: 9.2 ↓
	3: 10.7x →		3: 10.6x ↖
	4: 10.1 ←		4: 10.6x ↓
	5: 8.9 ↓		5: 10.2 →
	6: 10.5x ↘		6: 9.4 ↗
	7: 10.2 ↗		7: 10.2 →
	8: 9.5 ↗		8: 9.8 →
	9: 10.4x ↘		9: 10.6x ←
	10: 10.0 ↑		10: 9.7 ↑
	Series 96 ( 3x)		Series 95 ( 3x)
	289 (11x)		384 (14x)
Serie 5 	1: 10.0 ←	Serie 6 	1: 9.5 ↓
	2: 10.0 ←		2: 10.1 →
	3: 9.4 ←		3: 9.6 ↗
	4: 9.8 →		4: 10.1 ↓
	5: 9.1 ↓		5: 10.0 ↓
	6: 9.6 →		6: 10.5x ↑
	7: 10.6x →		7: 10.0 ↘
	8: 10.4x →		8: 9.8 ↘
	9: 10.3 →		9: 10.4x ↖
	10: 10.2 ↑		10: 9.6 →
	Series 96 ( 2x)		Series 96 ( 2x)
	480 (16x)		576 (18x)

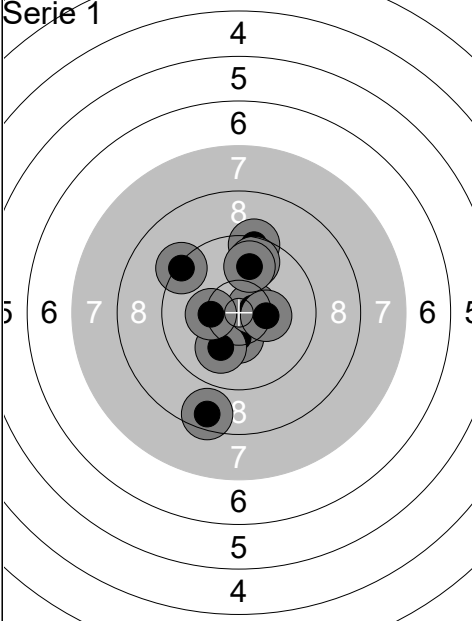
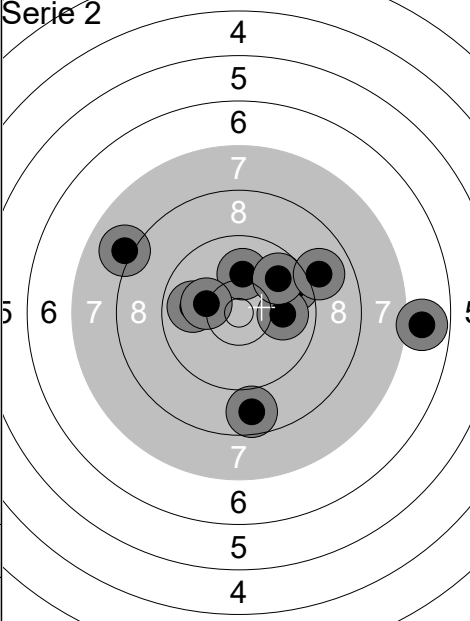
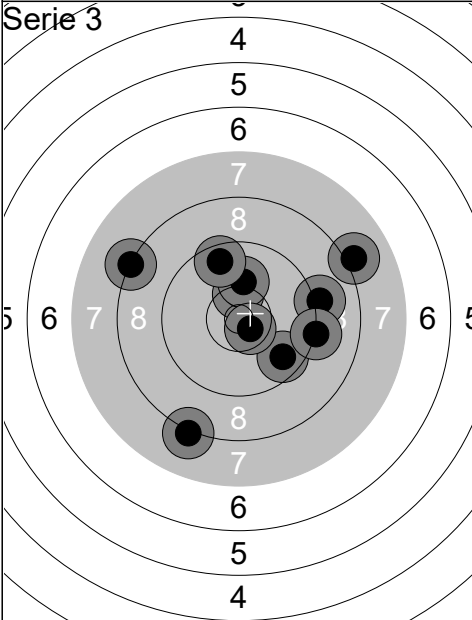
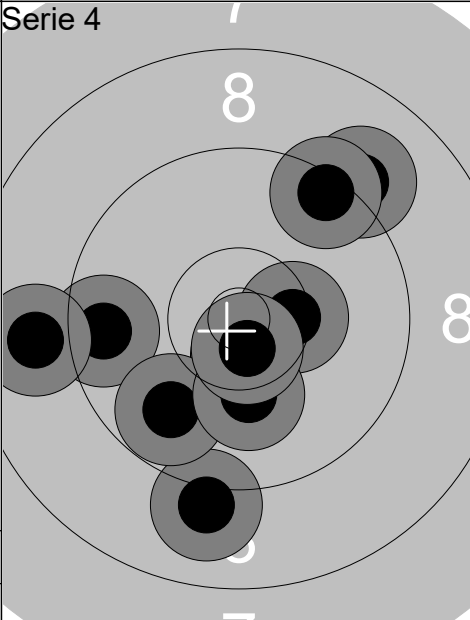
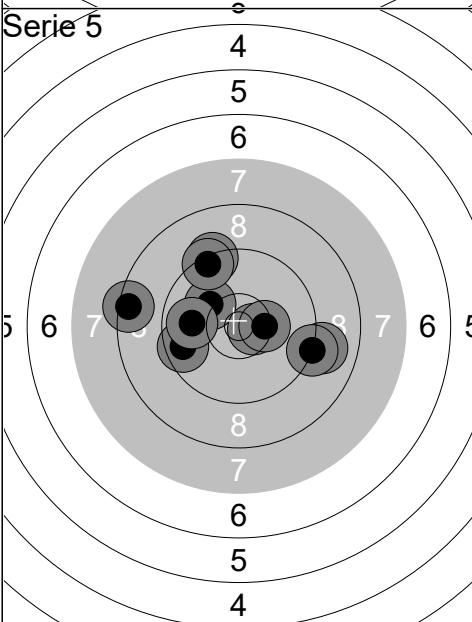
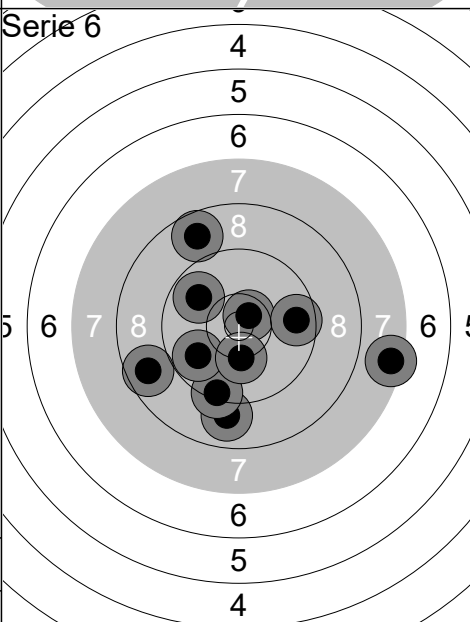
Relay	Lane	Hans Petter Norland		
5	12			
Day 1 Denmark Open Air		Lillestrøm og Omegns Presisjon	Mp	
08.03.2019	Day 1 Denmark Open Air	Denmark Open Air		
Serie 1		1: 10.4x ↓ 2: 9.4 ↑ 3: 9.8 ↑ 4: 10.1 ↓ 5: 9.3 ↖ 6: 10.6x → 7: 9.9 ↑ 8: 10.3 ← 9: 10.3 → 10: 8.6 ↓ Series 94 ( 2x) 94 ( 2x)	Serie 2 	1: 10.1 ↑ 2: 9.6 → 3: 8.1 ↖ 4: 10.0 → 5: 9.8 ↗ 6: 6.9 → 7: 9.0 → 8: 8.7 ↓ 9: 9.9 ← 10: 10.2 ← Series 88 ( 0x) 182 ( 2x)
Serie 3		1: 9.1 → 2: 9.6 ↘ 3: 9.2 → 4: 10.4x ↑ 5: 10.1 ↑ 6: 8.2 ↖ 7: 10.6x ↘ 8: 8.2 ↓ 9: 8.1 → 10: 9.6 ↑ Series 90 ( 2x) 272 ( 4x)	Serie 4 	1: 9.1 ↗ 2: 9.6 ← 3: 8.9 ← 4: 10.6x ↓ 5: 9.0 ↓ 6: 10.4x → 7: 9.8 ↘ 8: 9.4 ↗ 9: 10.2 ↓ 10: 10.6x ↓ Series 93 ( 3x) 365 ( 7x)
Serie 5		1: 9.3 ↑ 2: 10.1 ↖ 3: 10.6x → 4: 9.0 → 5: 9.4 ↑ 6: 10.4x → 7: 9.6 ← 8: 8.4 ← 9: 9.9 ← 10: 9.2 → Series 92 ( 2x) 457 ( 9x)	Serie 6 	1: 8.9 ↓ 2: 10.6x ↗ 3: 8.7 ↗ 4: 9.4 ↓ 5: 9.8 ↖ 6: 8.7 ← 7: 7.5 → 8: 9.9 ↖ 9: 10.2 ↓ 10: 9.7 → Series 87 ( 1x) 544 ( 10x)



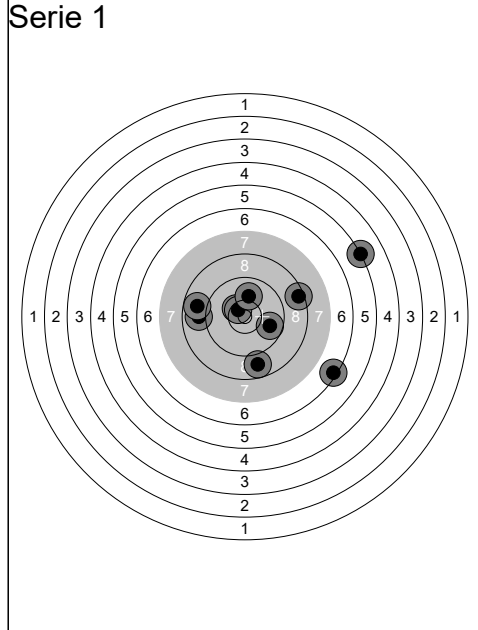

1:	8.8	↘
2:	8.9	←
3:	10.4x	↗
4:	6.4	↘
5:	8.8	←
6:	5.2	↗
7:	8.4	↗
8:	9.8	↘
9:	10.5x	↗
10:	10.1	↑
<b>Series</b>	<b>82 ( 2x)</b>	
	<b>82 ( 2x)</b>	

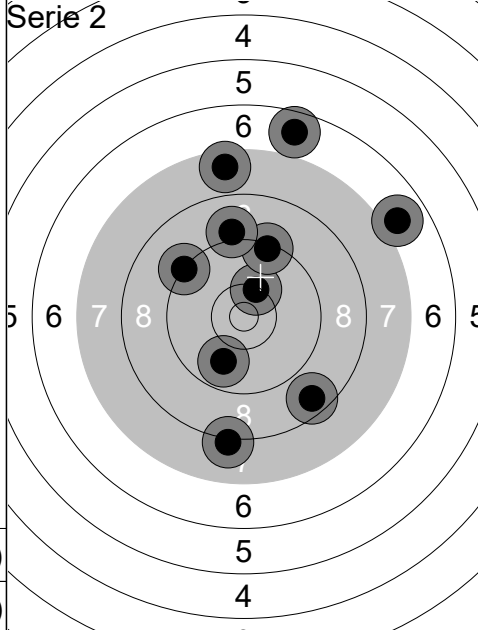

1:	9.2	↖
2:	10.3	↗
3:	6.7	↗
4:	9.3	↗
5:	8.1	↘
6:	9.9	↘
7:	8.6	↘
8:	9.0	↑
9:	7.6	↑
10:	6.9	↗
<b>Series</b>	<b>81 ( 0x)</b>	
	<b>163 ( 2x)</b>	

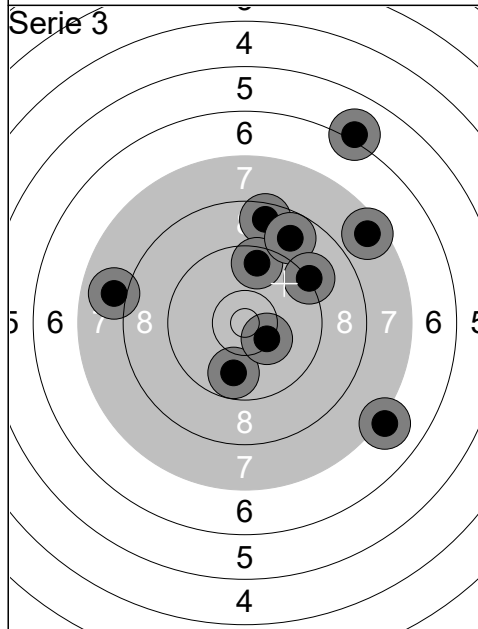

1:	7.1	↘
2:	9.8	↘
3:	7.6	↗
4:	8.6	↑
5:	6.1	↗
6:	9.6	↑
7:	8.0	←
8:	8.8	↗
9:	10.3	↘
10:	9.2	↗
<b>Series</b>	<b>81 ( 0x)</b>	
	<b>244 ( 2x)</b>	

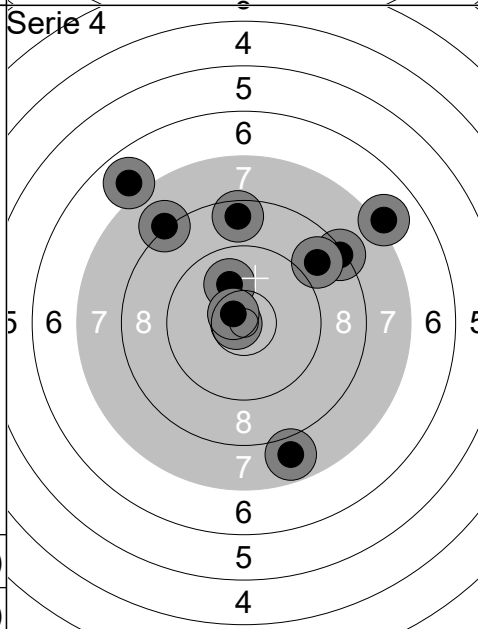

1:	10.8x	←
2:	10.0	↑
3:	6.9	↖
4:	8.3	↗
5:	7.1	↗
6:	8.6	↑
7:	7.8	↘
8:	8.2	↖
9:	10.6x	↖
10:	8.8	↗
<b>Series</b>	<b>82 ( 2x)</b>	
	<b>326 ( 4x)</b>	

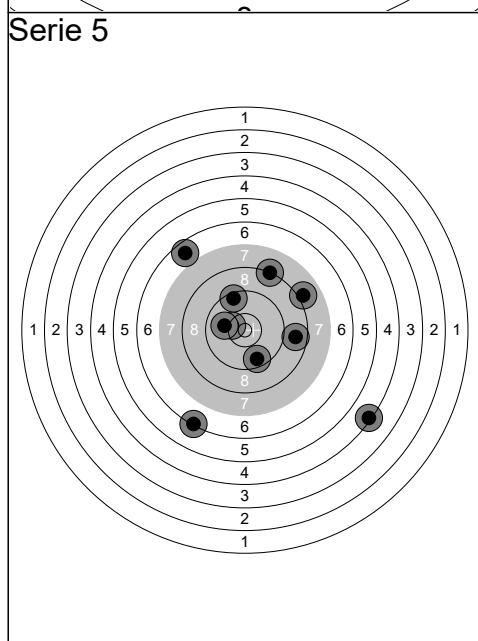

1:	10.4	←
2:	8.2	↗
3:	6.3	↘
4:	8.7	↗
5:	8.0	↗
6:	4.3	↘
7:	9.5	↗
8:	10.0	←
9:	9.6	↘
10:	6.7	↖
<b>Series</b>	<b>78 ( 0x)</b>	
	<b>404 ( 4x)</b>	

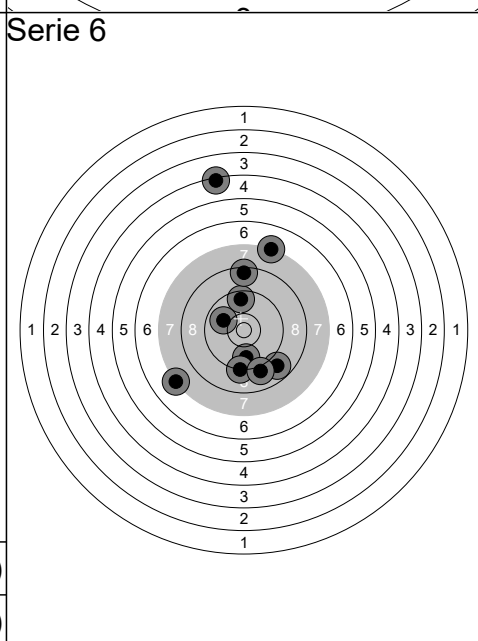

1:	7.2	↑
2:	9.8	↘
3:	8.8	↘
4:	9.2	↘
5:	9.6	↑
6:	7.2	↖
7:	4.3	↑
8:	10.0	←
9:	9.0	↘
10:	8.4	↑
<b>Series</b>	<b>80 ( 0x)</b>	
	<b>484 ( 4x)</b>	

Relay	Lane	Nofil Mulkana		
Day 1 Denmark Open Air	Bellahøj Skytteforening	Mp		
08.03.2019	Day 1 Denmark Open Air	Denmark Open Air		
Serie 1		1: 10.3 ↑	Serie 2	1: 9.0 ↗
		2: 9.6 ↑		2: 8.7 ➡
		3: 6.6 ↓		3: 9.0 ➡
		4: 8.0 ↘		4: 9.0 ➡
		5: 10.3 ↗		5: 9.3 ↗
		6: 9.3 ↓		6: 9.5 ↓
		7: 10.6x ➡		7: 8.6 ➡
		8: 9.7 ↑		8: 9.4 ↓
		9: 7.9 ↖		9: 7.7 ➡
		10: 8.6 ↘		10: 7.6 ↓
	Series 86 ( 1x)		Series 84 ( 0x)	
	86 ( 1x)		170 ( 1x)	
Serie 3		1: 10.3 ↑	Serie 4	1: 6.6 ↙
		2: 9.5 ←		2: 8.5 ↓
		3: 7.6 ➡		3: 9.1 ↓
		4: 9.2 ↓		4: 10.6x ↑
		5: 9.5 ↘		5: 10.5x ↓
		6: 8.6 ↓		6: 10.0 ➡
		7: 8.6 ➡		7: 8.4 ➡
		8: 9.7 ↑		8: 10.9x ↑
		9: 9.6 ←		9: 7.9 ➡
		10: 8.9 ➡		10: 6.8 ➡
	Series 86 ( 0x)		Series 84 ( 3x)	
	256 ( 1x)		340 ( 4x)	
Serie 5		1: 7.8 ➡	Serie 6	1: 10.0 ↙
		2: 9.5 ➡		2: 9.2 ↑
		3: 10.2 ↗		3: 9.7 ↑
		4: 8.2 ↖		4: 9.9 ↓
		5: 8.7 ↑		5: 9.5 ➡
		6: 7.8 ➡		6: 9.0 ↑
		7: 9.0 ↓		7: 9.6 ↙
		8: 9.3 ↑		8: 9.8 ←
		9: 9.7 ↑		9: 9.5 ↓
		10: 8.6 ➡		10: 8.6 ➡
	Series 84 ( 0x)		Series 90 ( 0x)	
	424 ( 4x)		514 ( 4x)	

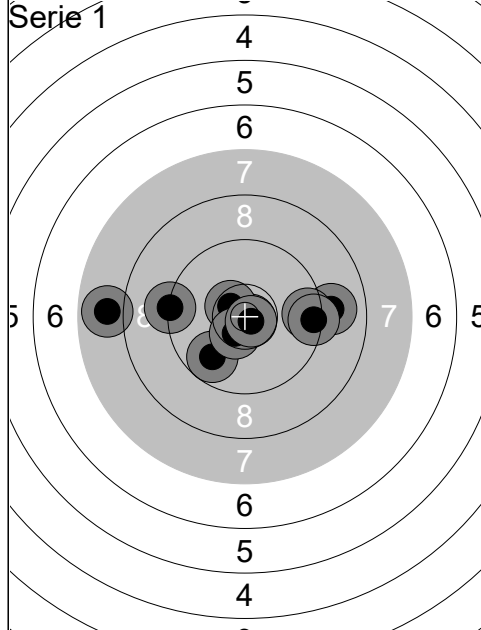

1:	7.9	←
2:	9.0	→
3:	9.5	→
4:	9.4	→
5:	10.8x	↘
6:	10.5x	↖
7:	9.8	↙
8:	10.5x	↙
9:	9.3	←
10:	10.8x	↘
<b>Series</b>	<b>92</b>	<b>( 4x)</b>
	<b>92</b>	<b>( 4x)</b>

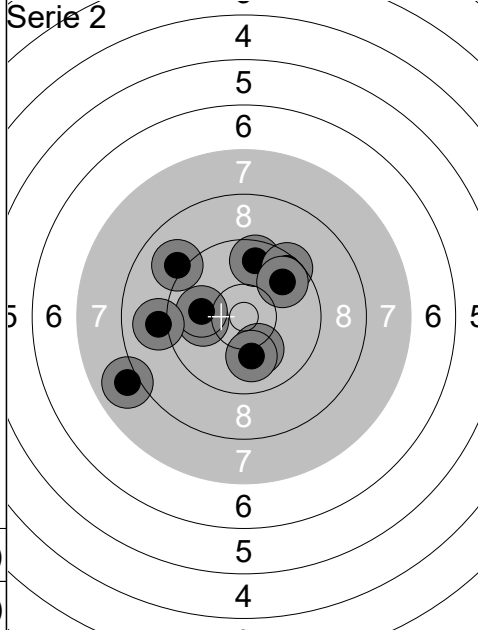

1:	10.0	←
2:	9.7	↑
3:	10.0	←
4:	9.0	←
5:	10.1	↘
6:	9.1	↖
7:	8.0	←
8:	9.5	↗
9:	9.8	↗
10:	10.1	↘
<b>Series</b>	<b>93</b>	<b>( 0x)</b>
	<b>185</b>	<b>( 4x)</b>

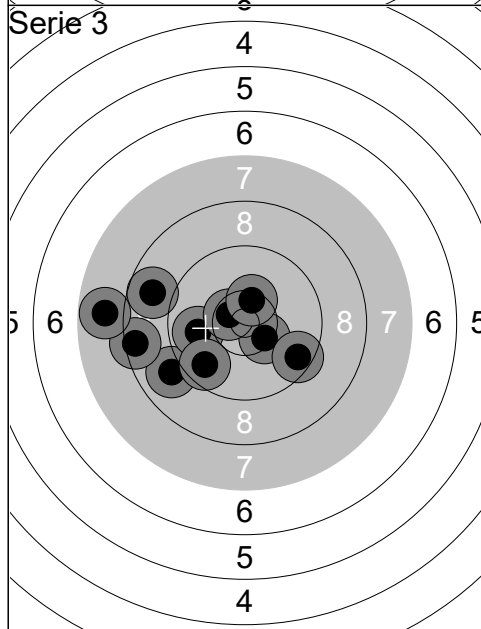

1:	9.0	←
2:	10.4x	↘
3:	8.5	←
4:	9.9	←
5:	9.7	↙
6:	7.8	←
7:	8.8	←
8:	10.5x	↖
9:	10.4x	↑
10:	9.5	↘
<b>Series</b>	<b>89</b>	<b>( 3x)</b>
	<b>274</b>	<b>( 7x)</b>

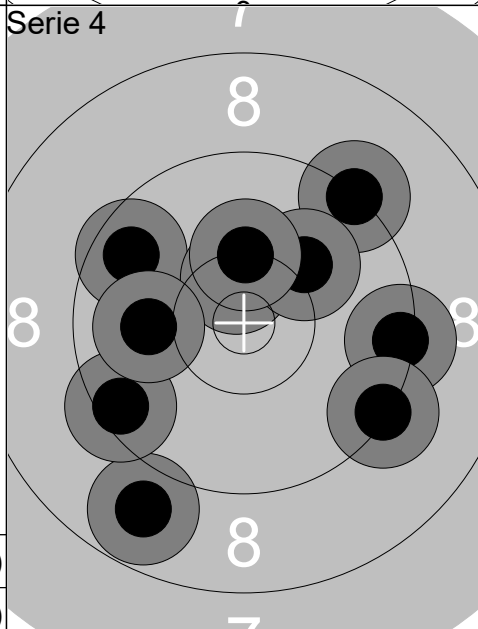

1:	9.2	↗
2:	8.8	↘
3:	9.6	↖
4:	9.4	←
5:	10.5x	↑
6:	10.1	↗
7:	10.0	←
8:	9.4	→
9:	10.3	↑
10:	9.3	↘
<b>Series</b>	<b>93</b>	<b>( 1x)</b>
	<b>367</b>	<b>( 8x)</b>

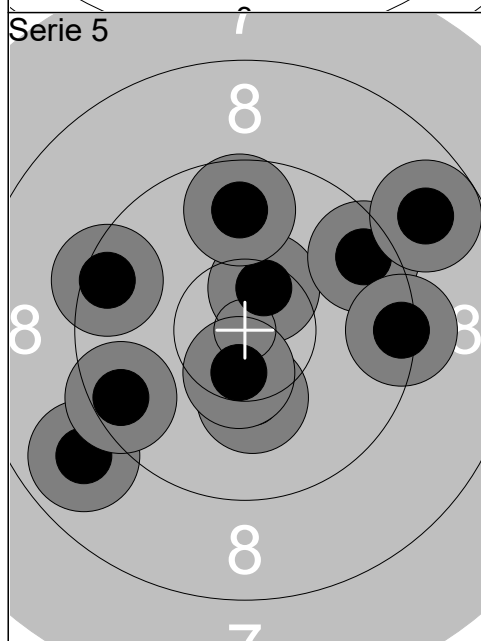

1:	8.9	↙
2:	10.5x	↑
3:	9.5	←
4:	9.5	↗
5:	8.8	↗
6:	10.3	↘
7:	10.5x	↘
8:	9.5	←
9:	9.4	→
10:	9.7	↑
<b>Series</b>	<b>91</b>	<b>( 2x)</b>
	<b>458</b>	<b>(10x)</b>

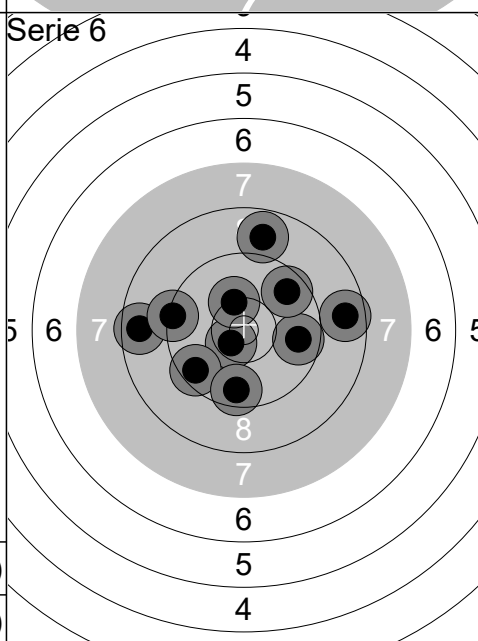

1:	8.6	←
2:	9.7	→
3:	10.5x	↙
4:	9.5	↙
5:	9.6	↘
6:	10.3	↑
7:	9.3	←
8:	8.7	→
9:	8.8	↑
10:	9.7	↗
<b>Series</b>	<b>89</b>	<b>( 1x)</b>
	<b>547</b>	<b>(11x)</b>