

1:	9.2	↖
2:	10.1	↓
3:	8.8	↙
4:	9.6	↓
5:	9.7	↘
6:	9.0	↔
7:	8.7	↗
8:	9.0	↗
9:	9.8	→
10:	7.7	↓
Serie		87 (0x)
Total		87 (0x)

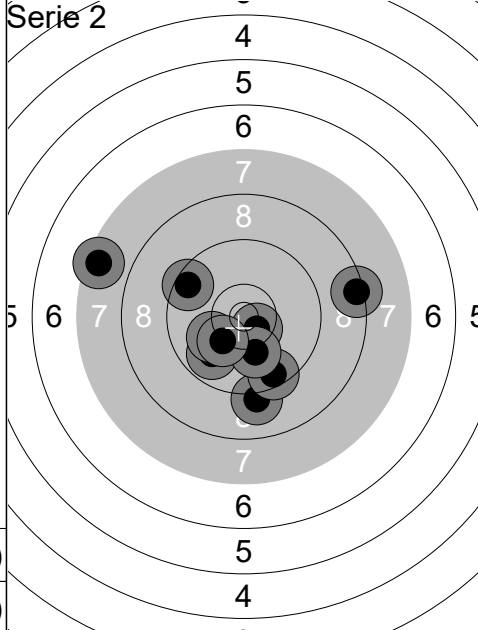

1:	10.5x	↘
2:	9.1	↓
3:	9.5	↖
4:	8.4	→
5:	7.5	↖
6:	9.9	↙
7:	10.1	↙
8:	9.5	↓
9:	10.1	↓
10:	10.2	↙
Serie		91 (1x)
Total		178 (1x)

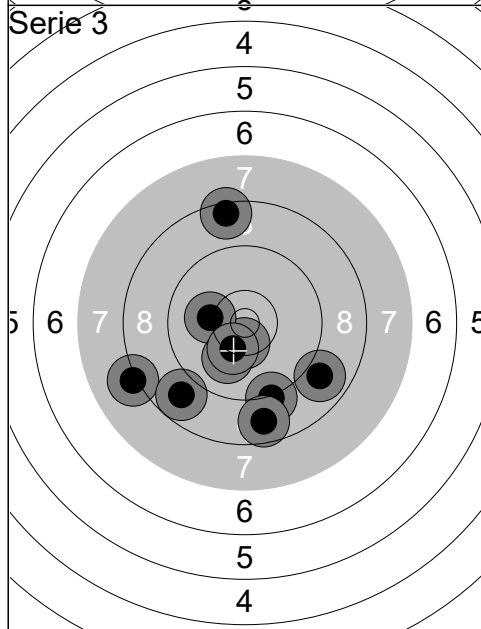

1:	10.5x	↓
2:	8.1	↖
3:	10.2	↔
4:	8.9	↘
5:	9.2	↓
6:	8.8	↙
7:	8.7	↓
8:	8.5	↗
9:	10.1	↓
10:	10.3	↓
Serie		89 (1x)
Total		267 (2x)

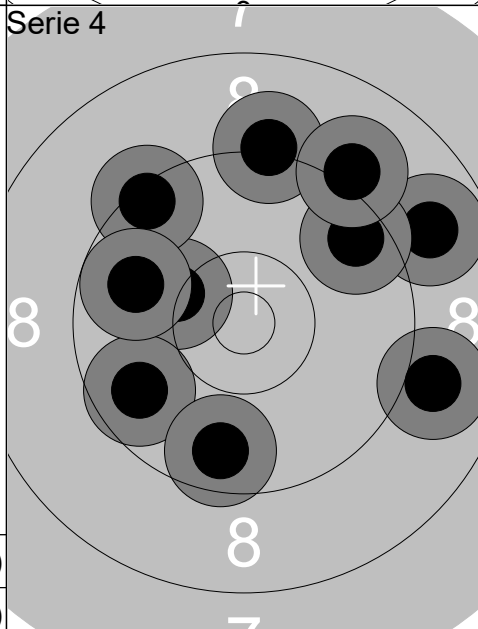

1:	10.2	↖
2:	9.4	↗
3:	9.7	↙
4:	8.8	→
5:	9.6	↓
6:	9.5	↗
7:	9.2	↗
8:	9.8	↖
9:	9.1	↗
10:	8.9	→
Serie		89 (0x)
Total		356 (2x)

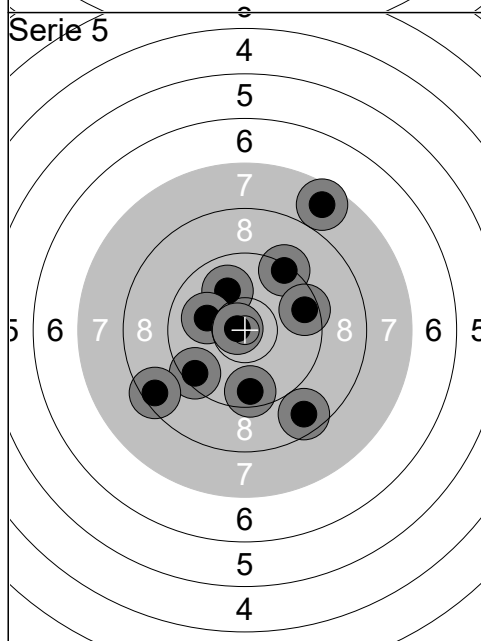

1:	10.0	↗
2:	9.5	↙
3:	9.3	↗
4:	8.7	↘
5:	8.5	↙
6:	9.5	→
7:	9.6	↓
8:	10.1	↔
9:	10.8x	↔
10:	7.7	↗
Serie		89 (1x)
Total		445 (3x)

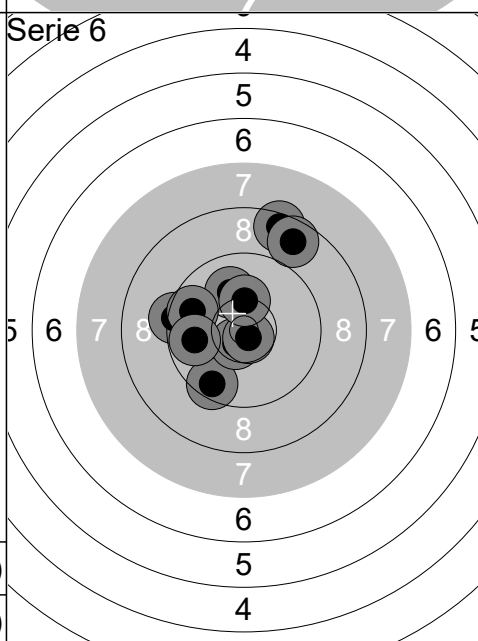

1:	8.5	↗
2:	10.0	↗
3:	9.4	↔
4:	9.7	↖
5:	9.5	↘
6:	10.6x	↘
7:	10.8x	↘
8:	8.7	↗
9:	9.8	↖
10:	10.3	↗
Serie		92 (2x)
Total		537 (5x)

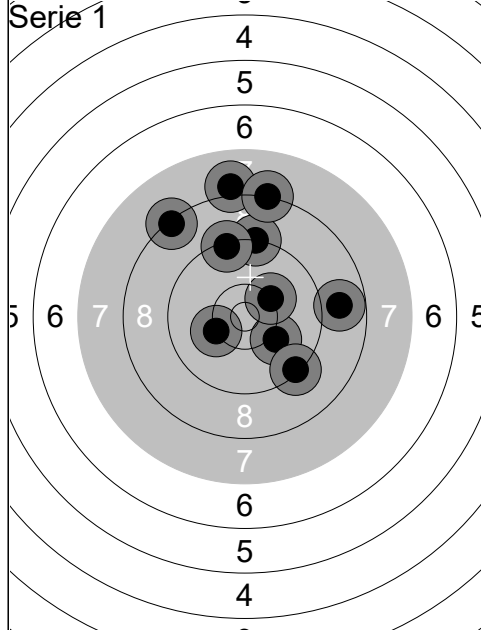

1:	10.1	↘
2:	10.2	↙
3:	8.3	↗
4:	9.2	↑
5:	8.0	↑
6:	8.2	↑
7:	10.2	↗
8:	8.8	→
9:	9.3	↘
10:	9.3	↑
Serie		89 (0x)
Total		89 (0x)

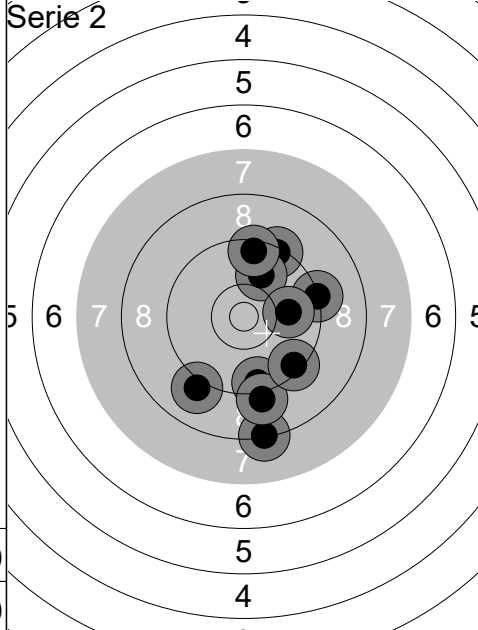

1:	9.4	↓
2:	9.3	↗
3:	9.9	↗
4:	8.3	↓
5:	9.0	↘
6:	9.5	↑
7:	9.1	↓
8:	9.3	→
9:	9.9	→
10:	9.4	↘
Serie		89 (0x)
Total		178 (0x)

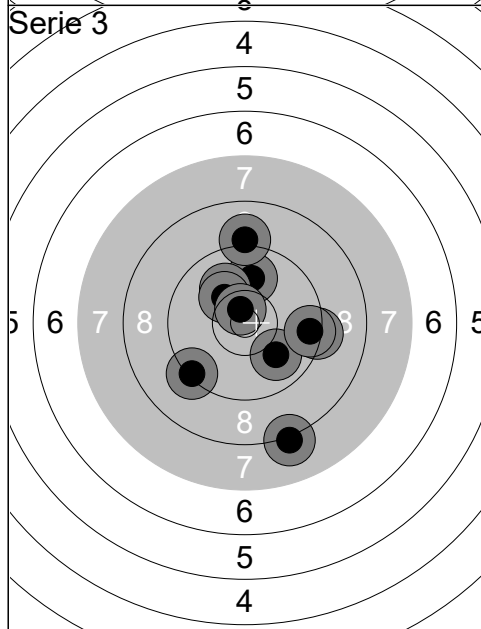

1:	10.0	↘
2:	9.3	↘
3:	9.3	→
4:	9.9	↑
5:	10.1	↗
6:	8.1	↘
7:	9.1	↑
8:	10.2	↗
9:	10.6x	↑
10:	9.5	→
Serie		93 (1x)
Total		271 (1x)

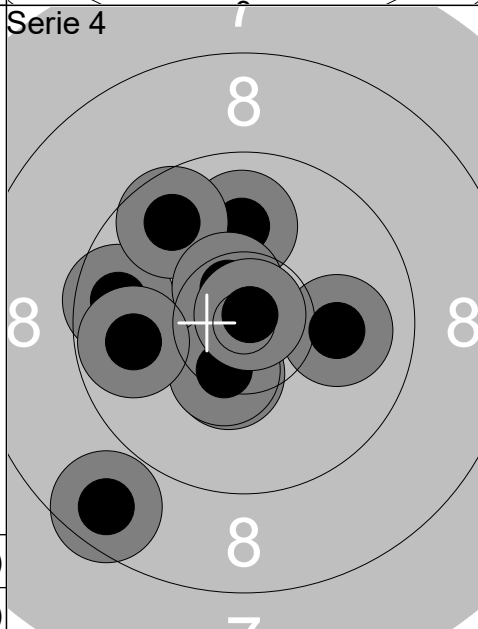

1:	9.7	←
2:	10.0	↑
3:	9.7	↗
4:	10.4x	↘
5:	10.6x	↗
6:	10.4x	↘
7:	8.6	↘
8:	10.0	→
9:	10.8x	↗
10:	9.8	←
Serie		95 (4x)
Total		366 (5x)

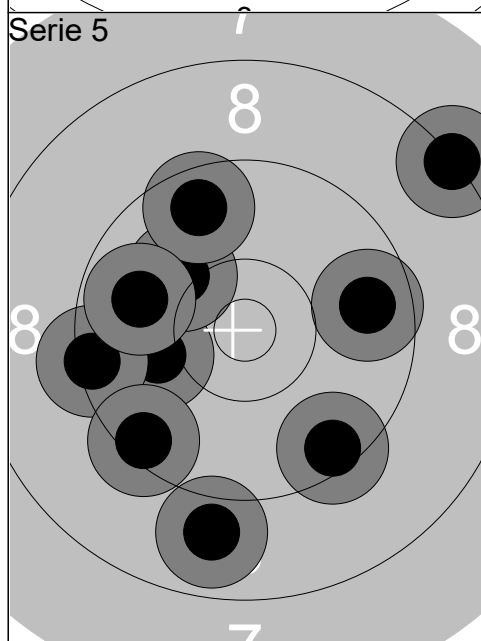

1:	10.0	←
2:	9.7	→
3:	9.4	←
4:	9.5	↘
5:	10.1	↗
6:	8.9	↘
7:	9.6	↑
8:	9.4	↘
9:	8.2	↗
10:	9.8	←
Serie		90 (0x)
Total		456 (5x)

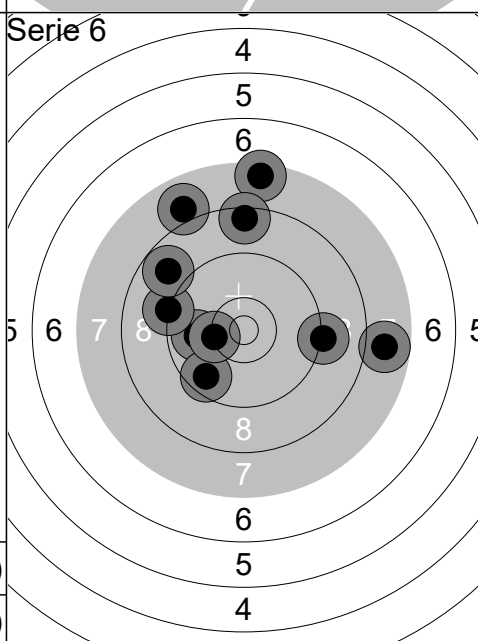

1:	7.8	→
2:	9.9	←
3:	7.5	↑
4:	7.9	↗
5:	8.5	↑
6:	9.6	↘
7:	10.3	←
8:	9.2	←
9:	8.8	↗
10:	9.2	→
Serie		83 (0x)
Total		539 (5x)

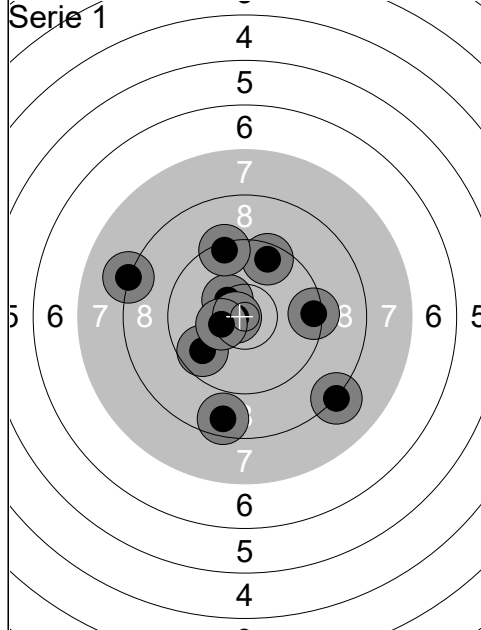

1:	10.4x ↗
2:	10.7x ←
3:	8.2 ↘
4:	9.4 →
5:	9.7 ↙
6:	9.6 ↗
7:	10.4x ←
8:	9.4 ↗
9:	8.6 ↘
10:	8.2 ←
Serie	90 (3x)
Total	90 (3x)

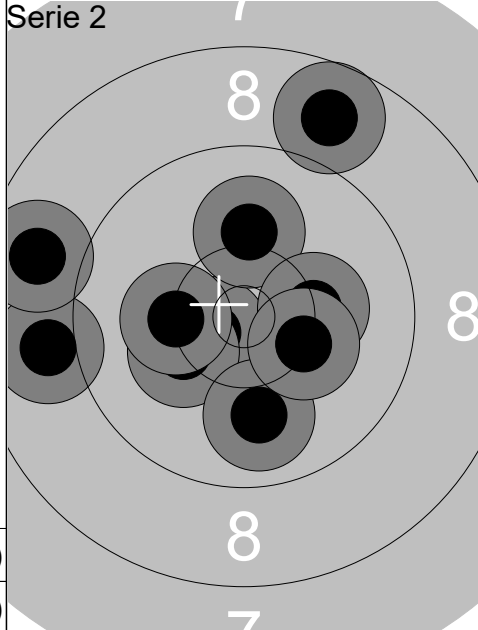

1:	10.6x ↙
2:	10.2 ↙
3:	8.9 ←
4:	8.8 ↗
5:	10.3 ←
6:	10.1 ↗
7:	9.9 ↘
8:	10.2 →
9:	8.8 ←
10:	10.3 ↘
Serie	93 (1x)
Total	183 (4x)

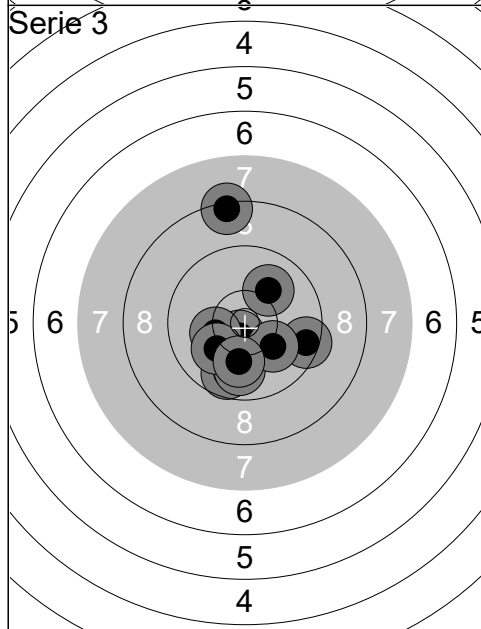

1:	10.0 ↗
2:	10.6x ↘
3:	8.4 ↗
4:	9.7 ↘
5:	9.9 ↘
6:	9.5 →
7:	10.1 ↘
8:	10.3 ←
9:	10.1 ↙
10:	10.1 ↘
Serie	95 (1x)
Total	278 (5x)

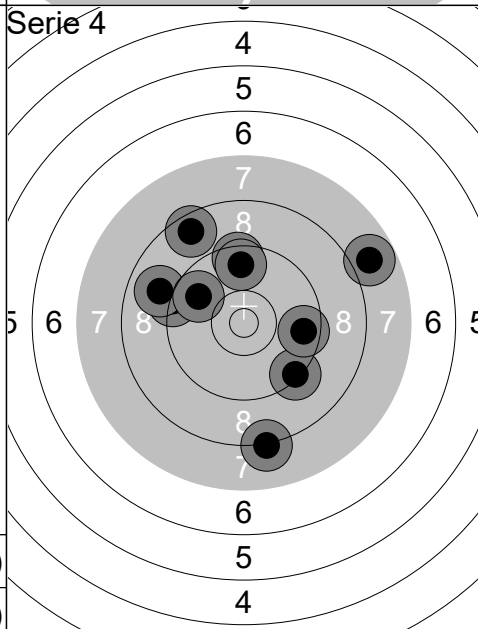

1:	8.6 ↗
2:	9.3 ↘
3:	8.2 ↘
4:	9.5 ↗
5:	9.3 ←
6:	8.9 ←
7:	9.7 ↗
8:	9.6 →
9:	9.8 ↙
10:	7.8 ↗
Serie	85 (0x)
Total	363 (5x)

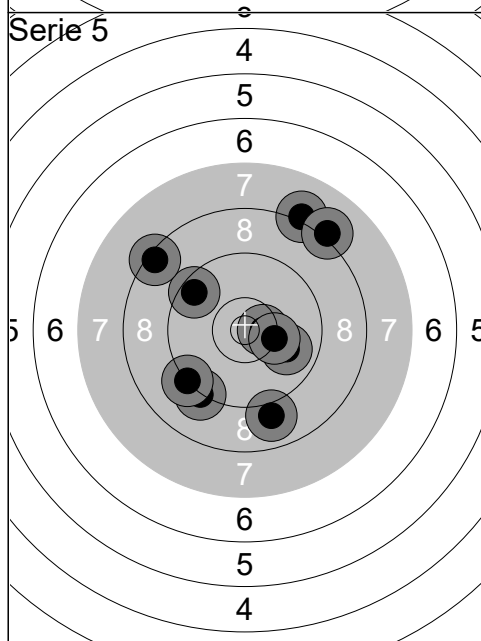

1:	9.2 ↘
2:	10.5x →
3:	9.2 ↙
4:	8.1 ↗
5:	9.5 ↙
6:	9.0 ↘
7:	9.9 ↘
8:	10.3 →
9:	8.4 ↗
10:	8.1 ↗
Serie	89 (1x)
Total	452 (6x)

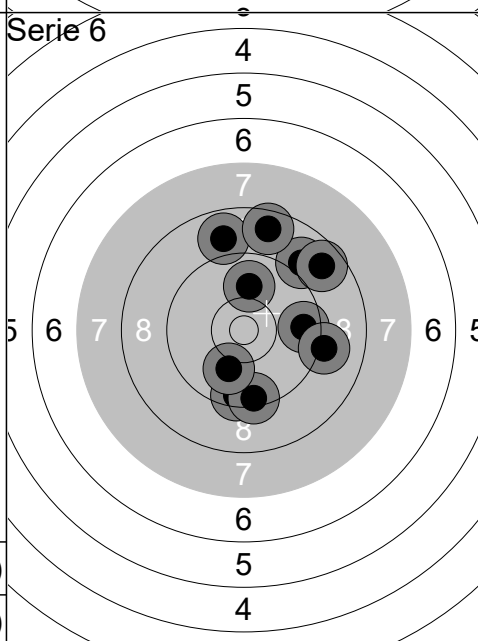

1:	9.6 →
2:	8.9 ↗
3:	9.1 →
4:	9.5 ↘
5:	9.4 ↘
6:	10.0 ↗
7:	10.0 ↘
8:	9.0 ↗
9:	8.7 ↗
10:	8.6 ↗
Serie	89 (0x)
Total	541 (6x)

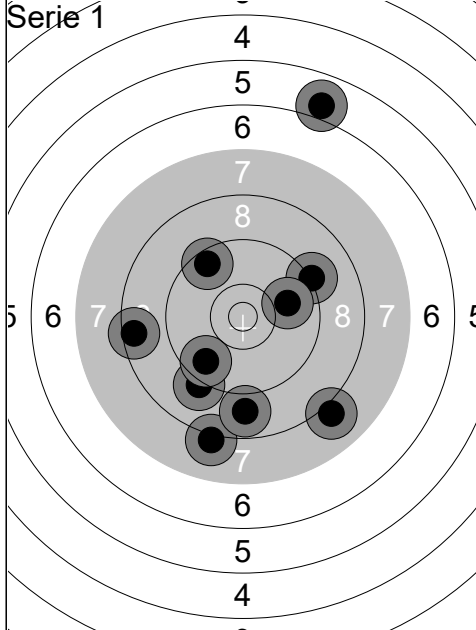

1:	8.5	←
2:	5.9	↑
3:	8.0	↘
4:	9.5	↗
5:	9.2	↗
6:	8.1	↓
7:	8.8	↓
8:	9.1	↓
9:	9.9	→
10:	9.6	↘
Serie		82 (0x)
Total		82 (0x)

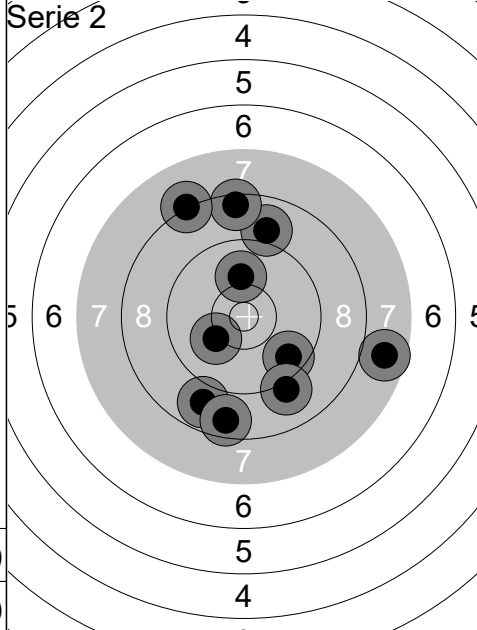

1:	10.0	↑
2:	7.7	→
3:	9.6	↘
4:	8.8	↘
5:	8.6	↓
6:	9.0	↑
7:	8.4	↑
8:	10.1	↙
9:	9.1	↘
10:	8.2	↗
Serie		86 (0x)
Total		168 (0x)

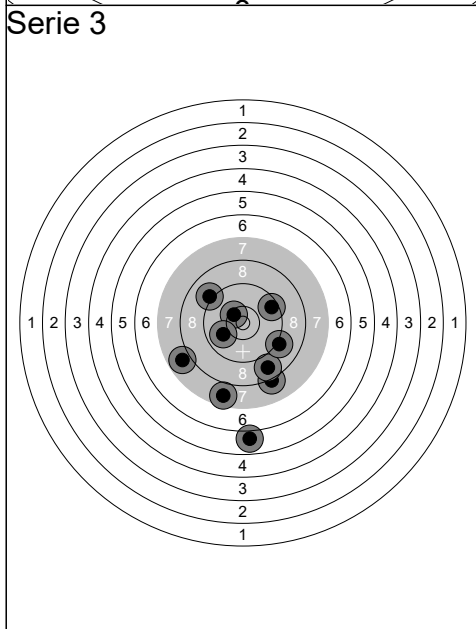

1:	10.4x	↘
2:	8.1	↓
3:	9.5	↗
4:	8.7	↓
5:	9.1	↗
6:	7.9	↙
7:	7.7	↓
8:	9.9	↙
9:	5.9	↓
10:	9.1	↘
Serie		81 (1x)
Total		249 (1x)

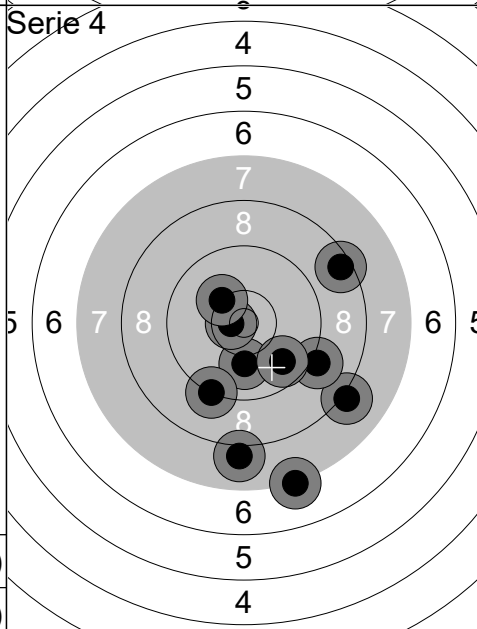

1:	10.0	↓
2:	9.2	↓
3:	10.7x	←
4:	7.2	↓
5:	8.1	↘
6:	8.0	↓
7:	9.1	↘
8:	10.2	↗
9:	9.7	↘
10:	8.5	↗
Serie		88 (1x)
Total		337 (2x)

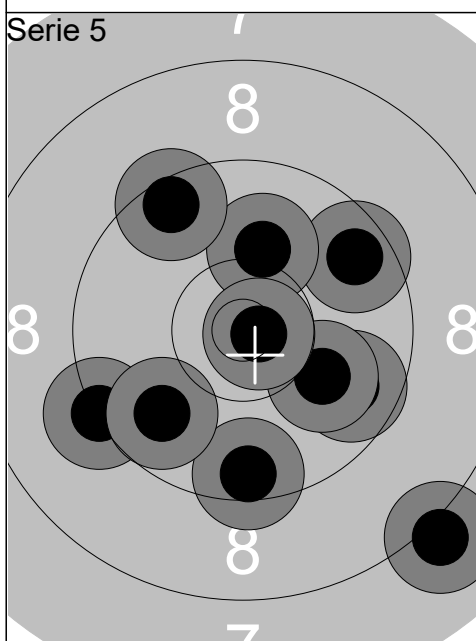

1:	9.7	↘
2:	9.6	↗
3:	10.1	↑
4:	10.0	↘
5:	10.8x	→
6:	9.3	↙
7:	9.5	↓
8:	9.8	↙
9:	8.1	↘
10:	9.5	↗
Serie		92 (1x)
Total		429 (3x)

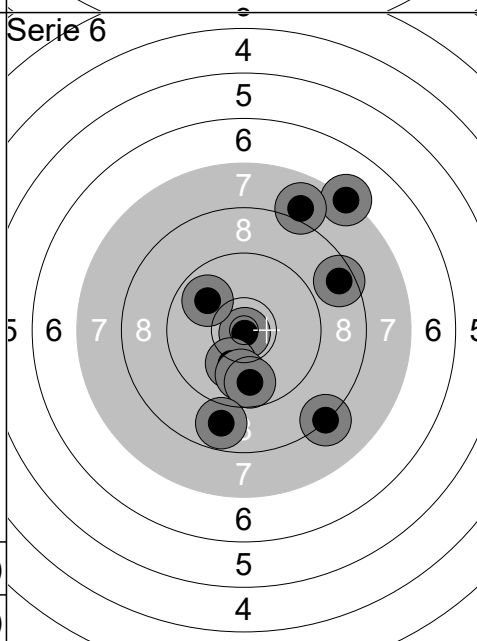

1:	7.3	↗
2:	10.9x	↓
3:	7.9	↗
4:	10.2	↓
5:	8.5	↗
6:	10.0	↓
7:	9.9	↗
8:	9.8	↓
9:	8.2	↘
10:	8.8	↓
Serie		86 (1x)
Total		515 (4x)

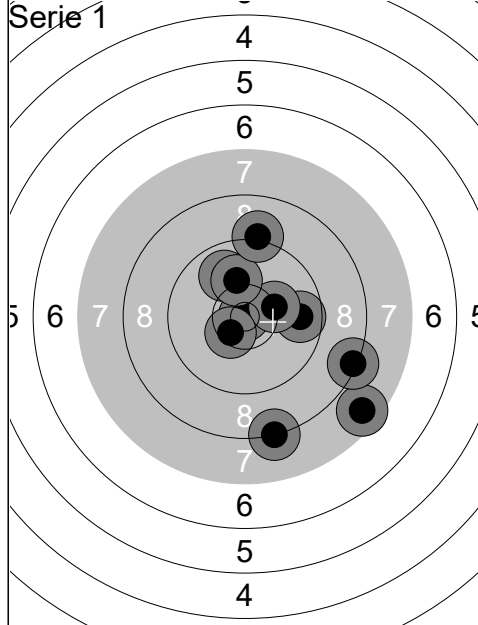

1:	10.9x ↙
2:	9.7 →
3:	7.6 ↘
4:	10.3 →
5:	10.5x ↙
6:	8.3 →
7:	8.2 ↓
8:	9.9 ↗
9:	10.1 ↑
10:	9.1 ↑
Serie 90 (2x)	
Total 90 (2x)	

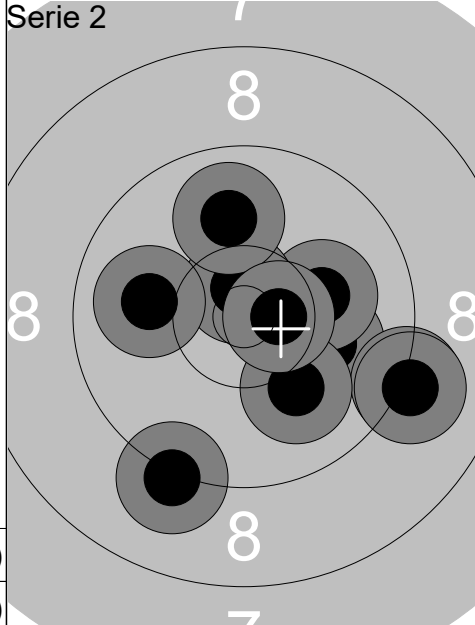

1:	10.0 →
2:	10.1 →
3:	9.2 →
4:	10.1 ↓
5:	9.2 ↓
6:	10.7x ↑
7:	9.9 ↑
8:	10.6x →
9:	9.1 →
10:	10.0 ←
Serie 96 (2x)	
Total 186 (4x)	

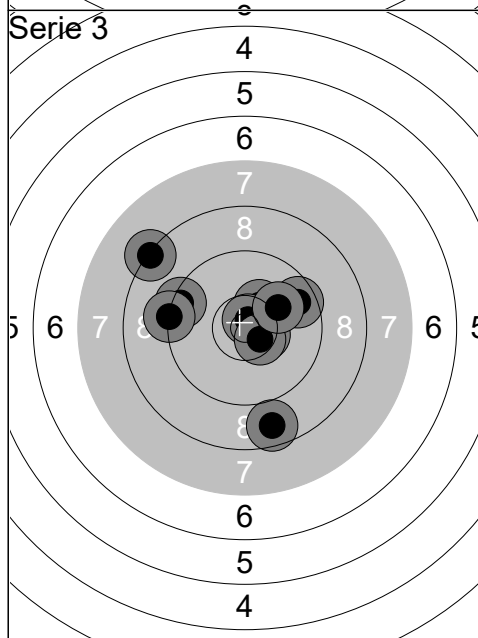

1:	8.3 ↖
2:	10.4 ↗
3:	9.4 ↖
4:	10.5x →
5:	8.7 ↓
6:	9.6 →
7:	10.7x ↑
8:	10.5x ↘
9:	9.2 ←
10:	10.1 ↗
Serie 93 (3x)	
Total 279 (7x)	

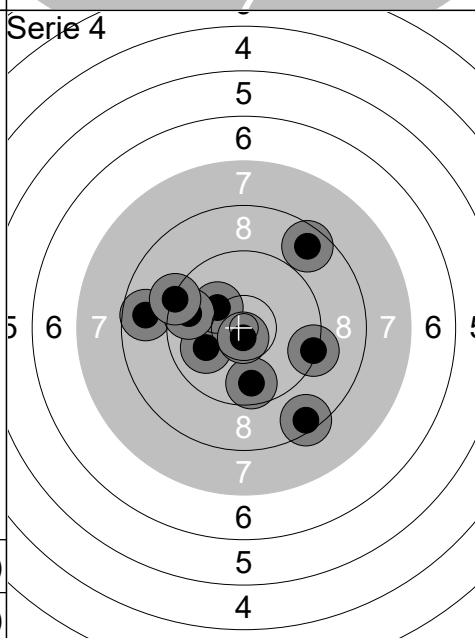

1:	8.6 ↗
2:	10.0 ↖
3:	8.5 ↘
4:	9.7 ↓
5:	10.2 ↗
6:	9.3 →
7:	10.7x ↓
8:	8.7 ←
9:	9.7 ←
10:	9.3 ←
Serie 90 (1x)	
Total 369 (8x)	

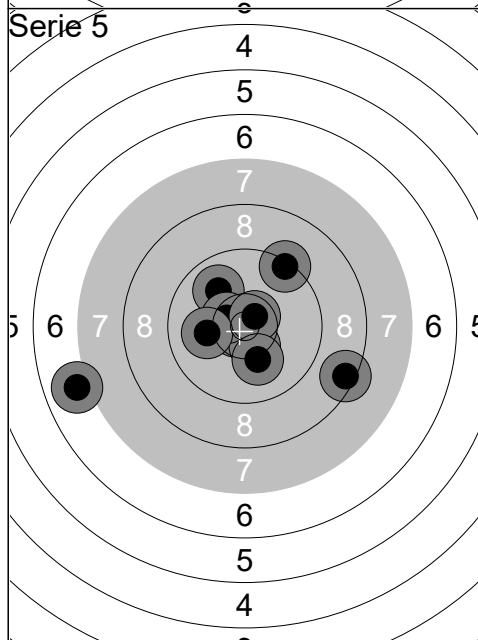

1:	10.7x ↙
2:	10.0 ↗
3:	8.4 →
4:	10.5x ↓
5:	10.5x ↙
6:	7.0 ←
7:	10.6x ↗
8:	9.3 ↗
9:	10.1 ←
10:	10.2 ↓
Serie 94 (4x)	
Total 463 (12x)	

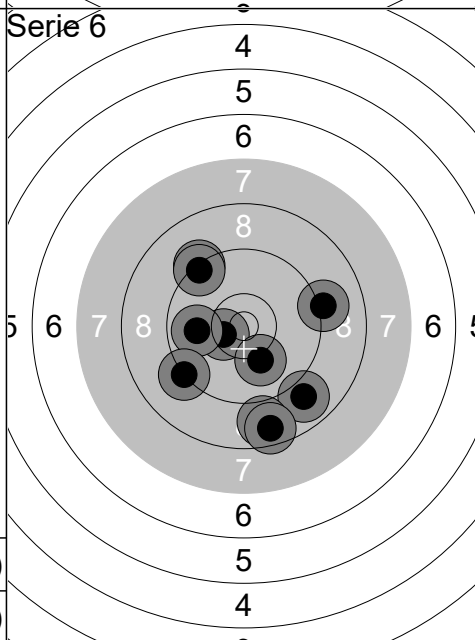

1:	10.4x ↙
2:	9.9 ←
3:	9.3 ↗
4:	8.9 ↘
5:	9.4 ↗
6:	9.2 ↙
7:	8.8 ↓
8:	10.1 ↓
9:	9.1 →
10:	8.6 ↓
Serie 89 (1x)	
Total 552 (13x)	

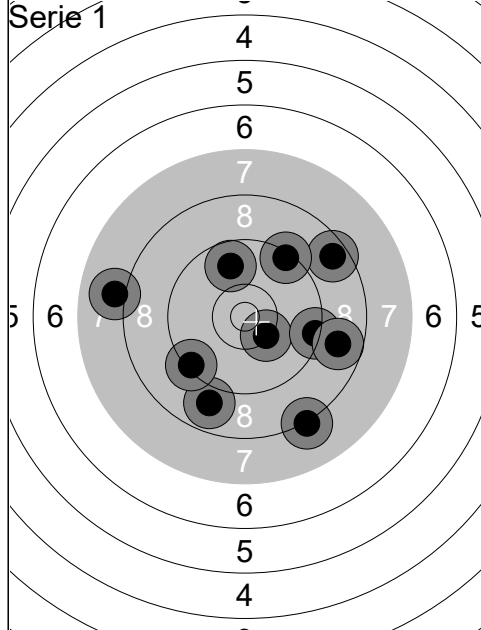

1:	8.6	↗
2:	8.0	←
3:	8.2	↘
4:	8.9	↘
5:	9.3	↗
6:	9.3	←
7:	10.3	↘
8:	9.3	→
9:	8.8	→
10:	9.8	↑
Serie		86 (0x)
Total		86 (0x)

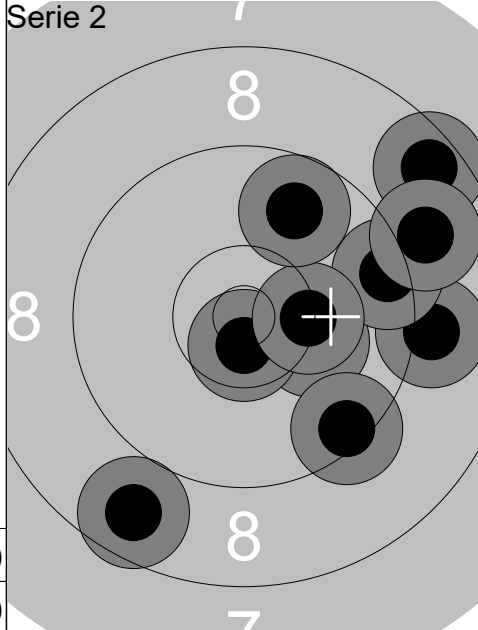

1:	8.6	↗
2:	10.2	→
3:	9.1	→
4:	10.7x	↘
5:	9.4	→
6:	8.7	↘
7:	10.3	→
8:	9.4	↘
9:	8.9	↗
10:	9.8	↑
Serie		90 (1x)
Total		176 (1x)

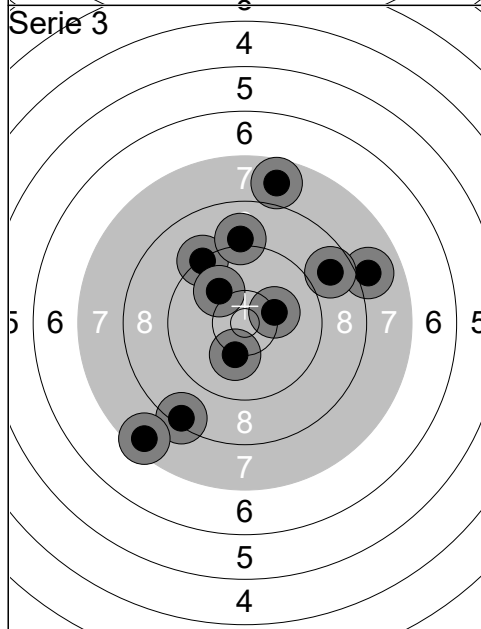

1:	10.2	→
2:	8.0	→
3:	9.3	↗
4:	10.0	↘
5:	8.4	↘
6:	8.7	↗
7:	9.1	↑
8:	7.7	↑
9:	7.5	↘
10:	10.2	↘
Serie		86 (0x)
Total		262 (1x)

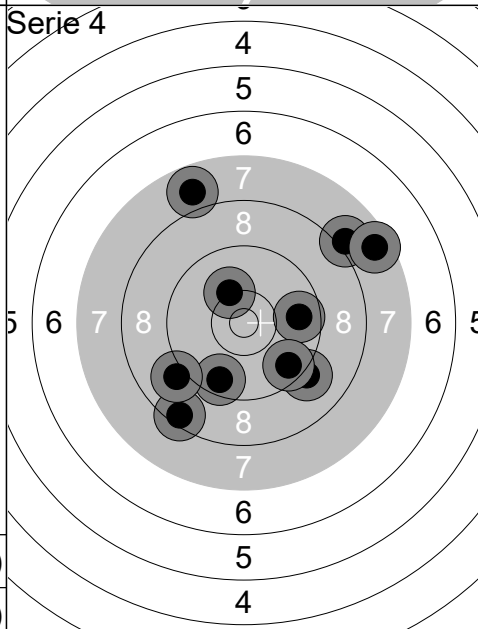

1:	8.4	↘
2:	9.1	↘
3:	9.6	↘
4:	8.0	↗
5:	9.7	→
6:	7.8	↑
7:	9.6	↘
8:	9.0	↘
9:	7.6	↗
10:	10.2	↑
Serie		85 (0x)
Total		347 (1x)

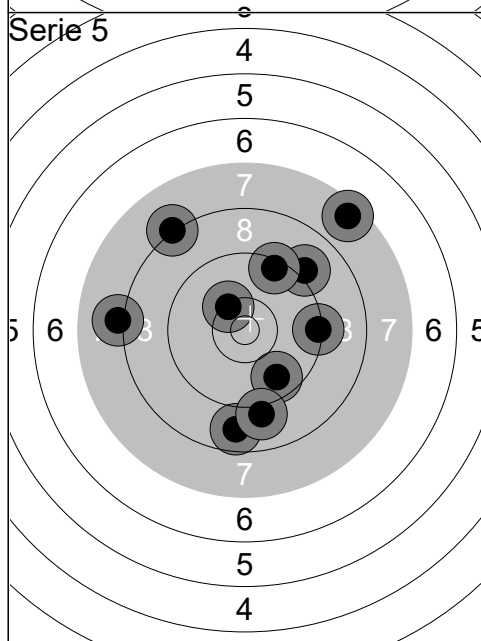

1:	9.1	↗
2:	9.7	↘
3:	9.4	↗
4:	10.3	↗
5:	8.1	←
6:	9.3	→
7:	8.2	↗
8:	8.7	↘
9:	9.0	↘
10:	7.5	↗
Serie		86 (0x)
Total		433 (1x)

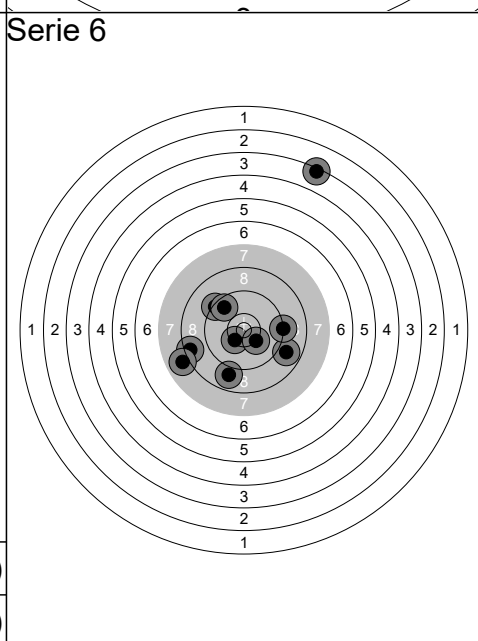

1:	10.4x	↘
2:	8.9	→
3:	8.5	←
4:	9.2	→
5:	3.4	↗
6:	10.3	↘
7:	8.9	↘
8:	7.9	↘
9:	9.3	↗
10:	9.6	↗
Serie		81 (1x)
Total		514 (2x)