

Relay	Lane	Cecilie Madsen	
Day 1 Denmark Open Air	Trehøje Skytteforening	WJ	
08.03.2019	Day 1 Denmark Open Air	Denmark Open Air	
Serie 1	1: 10.1 → 2: 10.2x → 3: 10.5x ← 4: 10.3x → 5: 10.2x ↓ 6: 10.2x ↗ 7: 9.8 → 8: 10.3x ↗ 9: 9.7 ↓ 10: 10.0 ↗ Series 101.3 101.3	Serie 2	1: 9.9 ↖ 2: 9.8 ↓ 3: 9.4 ↗ 4: 10.6x ↑ 5: 10.2x ↖ 6: 10.4x ↗ 7: 10.0 ↓ 8: 10.2x ↑ 9: 10.1 ↗ 10: 10.0 ↓ Series 100.6 201.9
Serie 3	1: 9.6 ← 2: 10.7x ↑ 3: 10.1 ↓ 4: 9.6 ↑ 5: 10.2x ← 6: 9.6 ← 7: 10.4x ↓ 8: 10.0 → 9: 10.4x ↖ 10: 9.5 ↓ Series 100.1 302.0	Serie 4	1: 9.9 → 2: 9.2 → 3: 10.1 → 4: 8.5 ← 5: 10.4x ↗ 6: 10.1 → 7: 9.9 ← 8: 9.9 ↗ 9: 10.5x ↓ 10: 10.2x ← Series 98.7 400.7
Serie 5	1: 10.1 ↑ 2: 10.3x ↖ 3: 10.4x ↗ 4: 9.7 ← 5: 9.4 ↗ 6: 8.9 ← 7: 9.2 ↖ 8: 9.4 ↗ 9: 10.2x ← 10: 8.8 ↓ Series 96.4 497.1	Serie 6	1: 9.8 ← 2: 10.4x ↑ 3: 9.4 ↓ 4: 9.7 ↓ 5: 9.8 ↓ 6: 10.4x → 7: 9.3 ↗ 8: 9.4 ↑ 9: 9.7 ← 10: 10.7x ← Series 98.6 595.7

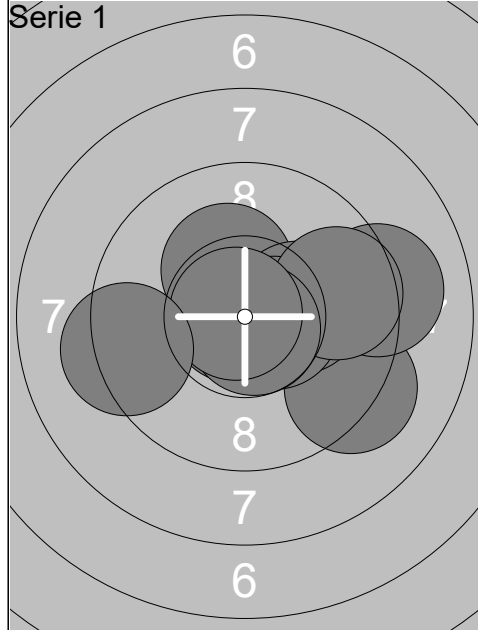

1:	9.2	↘
2:	10.3x	↗
3:	9.1	→
4:	10.2x	→
5:	10.5x	→
6:	10.8x	←
7:	9.6	→
8:	10.7x	↘
9:	10.8x	←
10:	9.3	←
<b>Series</b>	<b>100.5</b>	
	<b>100.5</b>	

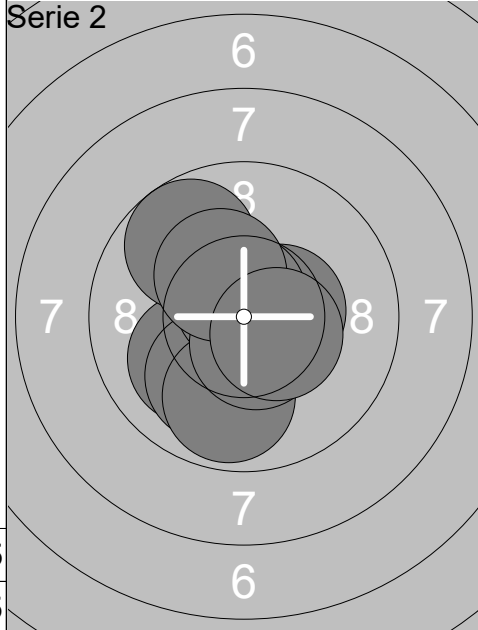

1:	10.1	↙
2:	10.7x	↘
3:	10.4x	→
4:	10.0	↘
5:	9.8	↘
6:	10.7x	↗
7:	9.7	↗
8:	10.5x	↘
9:	10.3x	↗
10:	10.4x	↘
<b>Series</b>	<b>102.6</b>	
	<b>203.1</b>	

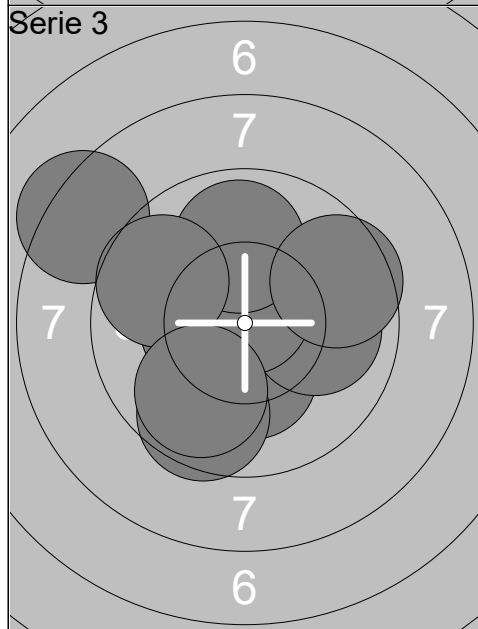

1:	10.2x	↘
2:	10.0	→
3:	10.4x	←
4:	10.7x	↗
5:	9.9	↗
6:	8.3	↖
7:	9.7	↖
8:	9.6	→
9:	9.6	↘
10:	9.8	↘
<b>Series</b>	<b>98.2</b>	
	<b>301.3</b>	

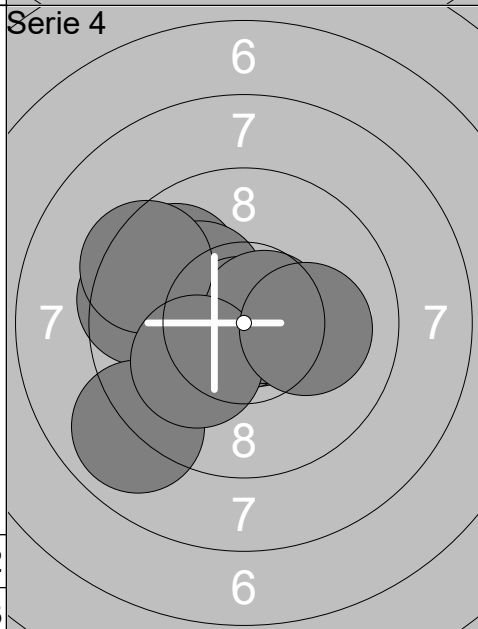

1:	10.8x	→
2:	9.7	↖
3:	9.5	←
4:	10.2x	↖
5:	10.9x	←
6:	10.6x	→
7:	8.9	↘
8:	9.4	↖
9:	10.1	↘
10:	10.1	→
<b>Series</b>	<b>100.2</b>	
	<b>401.5</b>	

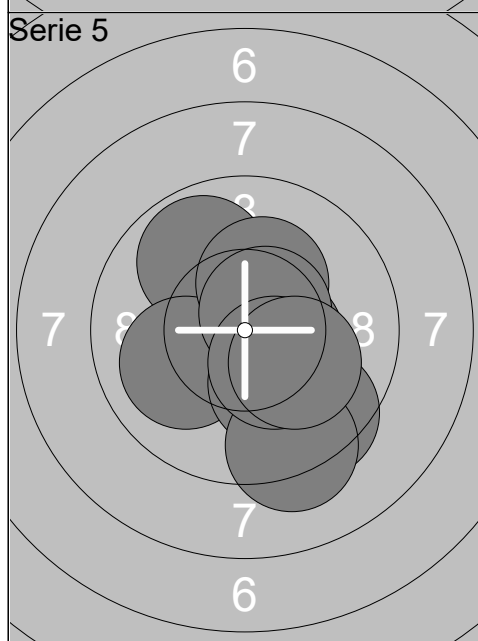

1:	10.5x	→
2:	9.5	↘
3:	9.8	↗
4:	10.0	←
5:	10.1	↘
6:	10.3x	↗
7:	10.5x	↗
8:	9.2	↘
9:	10.4x	↘
10:	10.1	↘
<b>Series</b>	<b>100.4</b>	
	<b>501.9</b>	

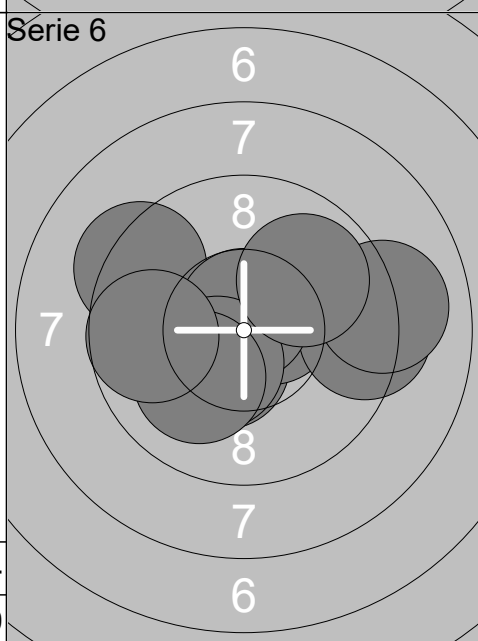

1:	10.4x	↘
2:	9.3	↖
3:	10.5x	→
4:	9.3	→
5:	10.7x	↗
6:	10.3x	↘
7:	9.0	→
8:	9.9	↗
9:	10.0	↘
10:	9.7	←
<b>Series</b>	<b>99.1</b>	
	<b>601.0</b>	

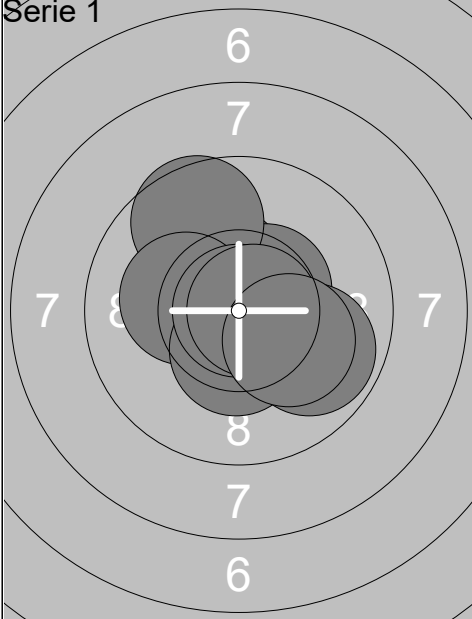
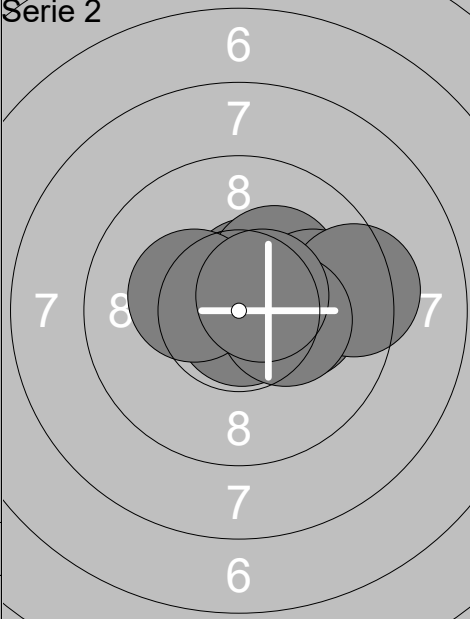
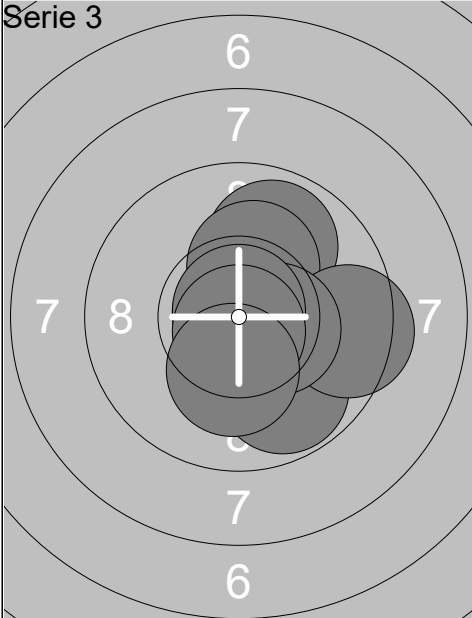
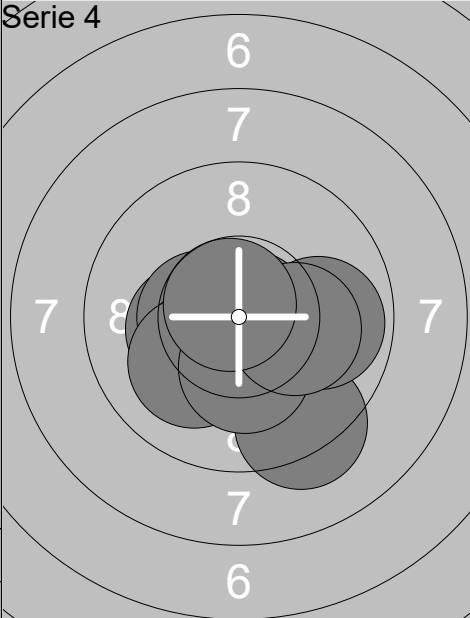
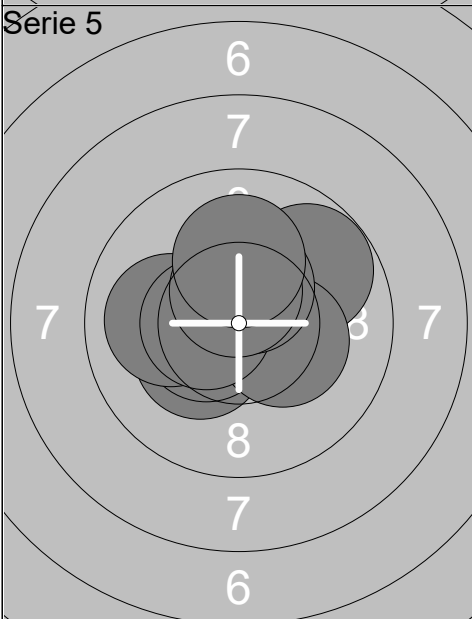
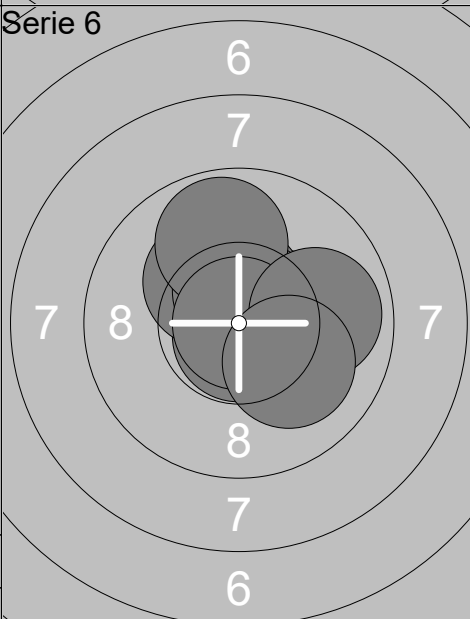
Relay	Lane	Christine Jacobi		
Day 1 Denmark Open Air	Viborg Skytte Forening	WJ		
08.03.2019	Day 1 Denmark Open Air	Denmark Open Air		
Serie 1		1: 10.3x ↖ 2: 10.5x ↗ 3: 10.5x ↗ 4: 9.6 ↖ 5: 10.2x ↙ 6: 10.4x ↓ 7: 9.8 ↘ 8: 10.9x 9: 10.7x → 10: 10.1 ↘ Series 103.0 103.0	Serie 2 	1: 10.5x ↗ 2: 10.7x ↑ 3: 10.2x ↗ 4: 9.9 → 5: 10.8x ↓ 6: 10.3x ↙ 7: 10.2x → 8: 9.3 → 9: 10.3x → 10: 10.5x ↗ Series 102.7 205.7
Serie 3		1: 10.7x ↗ 2: 9.9 ↗ 3: 10.2x ↑ 4: 9.8 ↓ 5: 9.4 → 6: 10.9x ↑ 7: 10.4x → 8: 10.8x ↑ 9: 10.7x ↓ 10: 10.2x ↓ Series 103.0 308.7	Serie 4 	1: 10.3x ↙ 2: 10.8x → 3: 9.3 ↓ 4: 9.8 → 5: 10.5x ↙ 6: 10.3x ↙ 7: 10.1 ↙ 8: 10.2x ↓ 9: 10.2x → 10: 10.7x ↖ Series 102.2 410.9
Serie 5		1: 10.3x ↙ 2: 10.7x ↖ 3: 10.5x ↙ 4: 10.0 ← 5: 9.8 ↗ 6: 10.3x → 7: 10.5x ↙ 8: 10.4x ↑ 9: 10.5x ↑ 10: 10.1 ↑ Series 103.1 514.0	Serie 6 	1: 10.9x ↓ 2: 10.3x → 3: 10.8x ↓ 4: 10.2x ↖ 5: 10.5x ↑ 6: 10.7x ↗ 7: 9.8 ↑ 8: 10.9x 9: 9.9 → 10: 10.1 ↘ Series 104.1 618.1

Relay	Lane	Katrine Christensen		
4	9	Tuse Skytteforening		WJ
Day 1 Denmark Open Air		Day 1 Denmark Open Air		Denmark Open Air
08.03.2019				
<b>Serie 1</b> 	1: 10.3x ↗	<b>Serie 2</b> 	1: 10.3x ↖	
	2: 9.4 ↖		2: 10.0 ↗	
	3: 9.4 →		3: 9.2 ↖	
	4: 9.9 ↖		4: 10.4x ↙	
	5: 10.8x ↗		5: 9.6 ↘	
	6: 9.9 ↖		6: 10.7x ↗	
	7: 10.1 ←		7: 7.1 ←	
	8: 10.7x ↘		8: 10.2x ←	
	9: 9.9 ↙		9: 9.4 ←	
	10: 10.2x ↖		10: 10.5x ↗	
	<b>Series</b> 100.6		<b>Series</b> 97.4	
	100.6		198.0	
<b>Serie 3</b> 	1: 10.1 ←	<b>Serie 4</b> 	1: 10.6x ↘	
	2: 9.9 ↗		2: 8.0 →	
	3: 8.6 →		3: 10.5x →	
	4: 8.0 →		4: 10.0 ↗	
	5: 9.4 ↘		5: 9.3 ↖	
	6: 10.1 ↘		6: 10.6x →	
	7: 9.6 ↘		7: 9.7 →	
	8: 8.5 →		8: 10.2x →	
	9: 10.8x ↗		9: 9.9 ↘	
	10: 9.7 →		10: 10.3x →	
	<b>Series</b> 94.7		<b>Series</b> 99.1	
	292.7		391.8	
<b>Serie 5</b> 	1: 10.6x ↗	<b>Serie 6</b> 	1: 10.0 ↖	
	2: 10.7x ↘		2: 10.1 ←	
	3: 9.1 →		3: 10.8x ↗	
	4: 9.8 ↖		4: 10.2x ↘	
	5: 10.2x ↘		5: 10.2x →	
	6: 10.5x ←		6: 10.5x ↘	
	7: 10.5x →		7: 10.8x →	
	8: 10.0 →		8: 8.6 ←	
	9: 9.7 ←		9: 10.1 →	
	10: 10.3x ↘		10: 10.5x ↗	
	<b>Series</b> 101.4		<b>Series</b> 101.8	
	493.2		595.0	

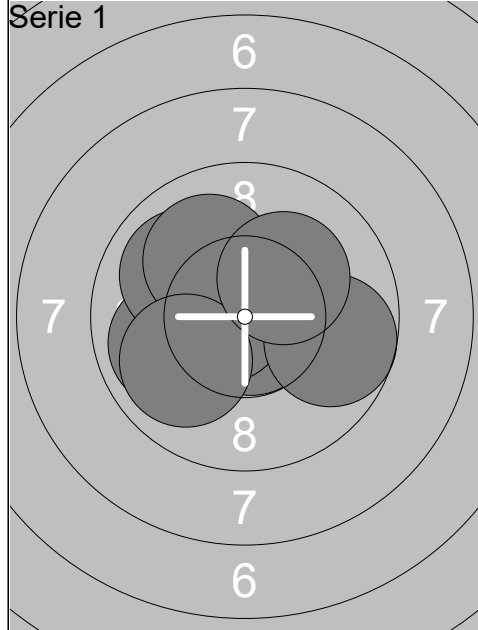

1:	9.9	←
2:	10.8x	→
3:	10.7x	↗
4:	10.8x	↘
5:	10.0	↖
6:	10.6x	←
7:	9.7	→
8:	10.0	↗
9:	9.9	←
10:	10.2x	↗
<b>Series</b>	<b>102.6</b>	
	<b>102.6</b>	

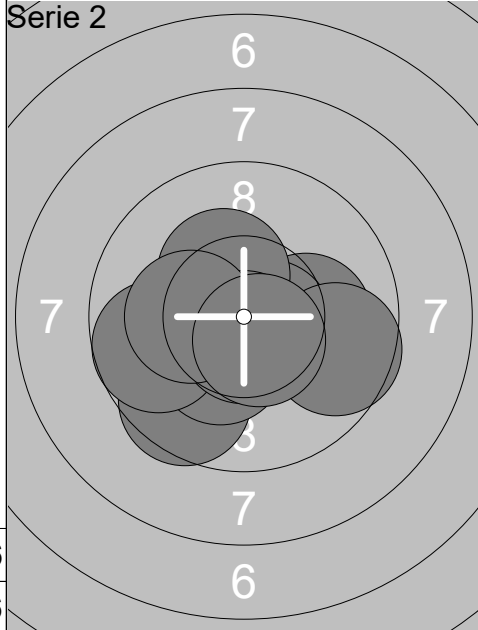

1:	10.1	→
2:	9.6	↘
3:	10.3x	↘
4:	9.7	←
5:	10.6x	→
6:	10.3x	↗
7:	10.7x	↘
8:	10.2x	←
9:	9.6	→
10:	10.5x	↘
<b>Series</b>	<b>101.6</b>	
	<b>204.2</b>	

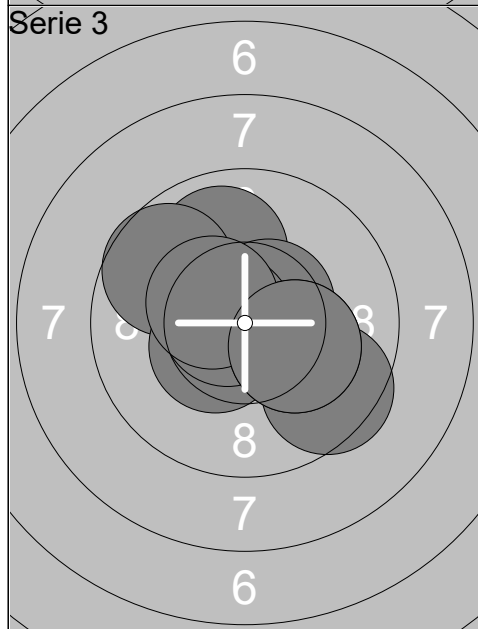

1:	9.9	↗
2:	10.8x	↗
3:	9.7	↖
4:	10.4x	↘
5:	10.5x	↗
6:	9.5	↘
7:	10.7x	←
8:	10.2x	→
9:	10.4x	↖
10:	10.2x	→
<b>Series</b>	<b>102.3</b>	
	<b>306.5</b>	

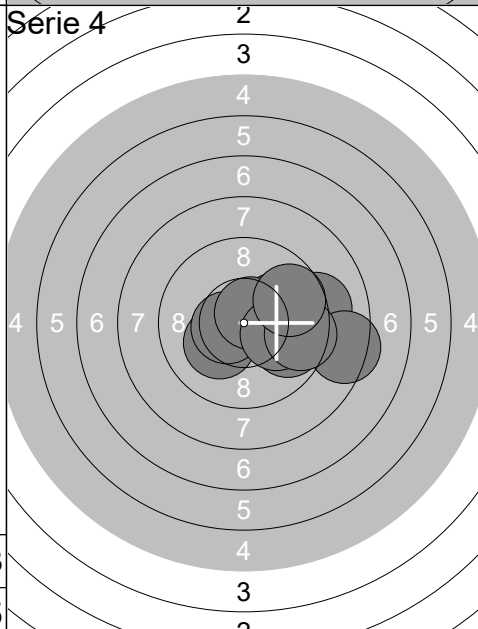

1:	10.2x	↘
2:	10.5x	←
3:	9.8	→
4:	9.1	→
5:	8.4	→
6:	10.0	↗
7:	10.6x	↗
8:	10.1	→
9:	9.5	→
10:	9.7	↗
<b>Series</b>	<b>97.9</b>	
	<b>404.4</b>	

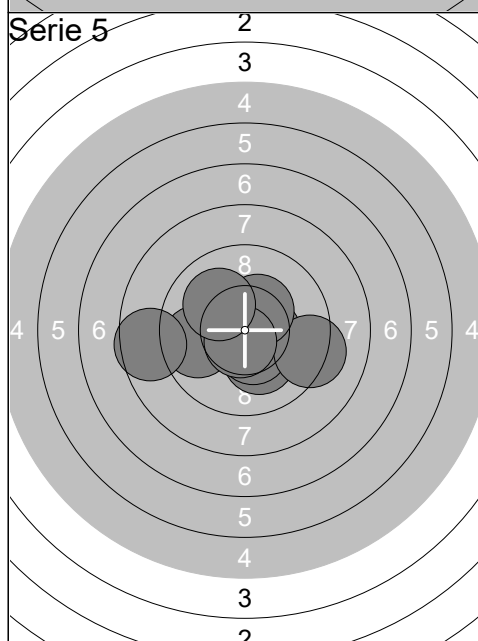

1:	10.2x	↘
2:	10.4x	→
3:	10.6x	→
4:	10.4x	↘
5:	9.2	→
6:	9.7	←
7:	10.4x	↗
8:	10.6x	↘
9:	8.6	←
10:	10.0	↖
<b>Series</b>	<b>100.1</b>	
	<b>504.5</b>	

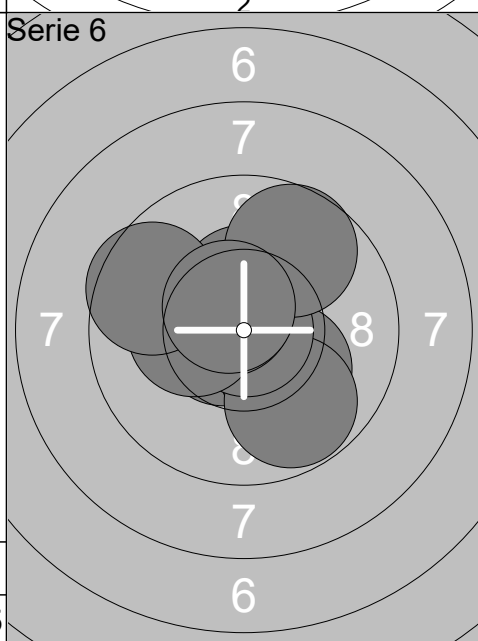

1:	10.4x	↗
2:	10.6x	←
3:	10.2x	↘
4:	9.8	↘
5:	10.9x	→
6:	10.5x	↖
7:	10.3x	←
8:	9.6	↖
9:	9.7	↗
10:	10.6x	↖
<b>Series</b>	<b>102.6</b>	
	<b>607.1</b>	

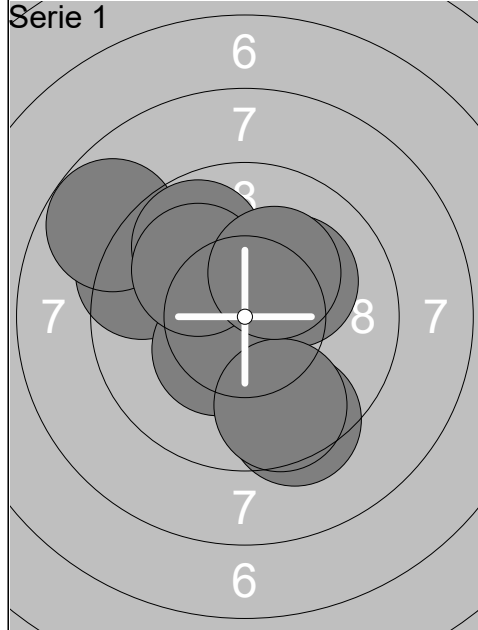

1:	10.1	↗
2:	9.4	↖
3:	10.4x	↘
4:	10.4x	↘
5:	9.4	↘
6:	9.6	↘
7:	8.8	↗
8:	9.8	↗
9:	10.0	↗
10:	10.2x	↗
<b>Series</b>		<b>98.1</b>
		<b>98.1</b>

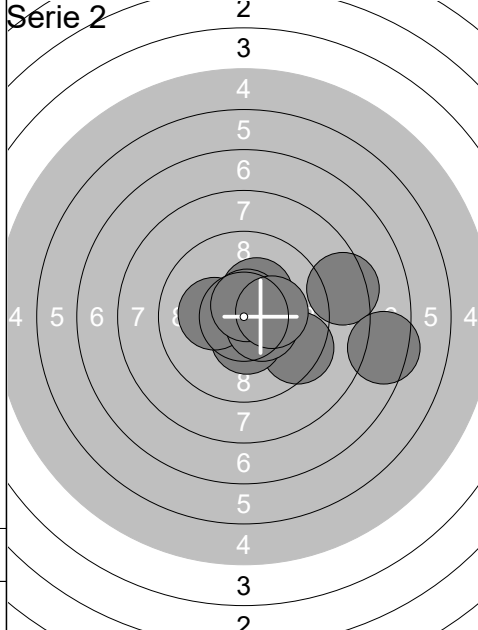

1:	9.4	↘
2:	10.3x	↗
3:	10.8x	↖
4:	10.4x	↘
5:	8.4	→
6:	10.2x	↖
7:	10.4x	→
8:	10.6x	↗
9:	7.4	→
10:	10.2x	→
<b>Series</b>		<b>98.1</b>
		<b>196.2</b>

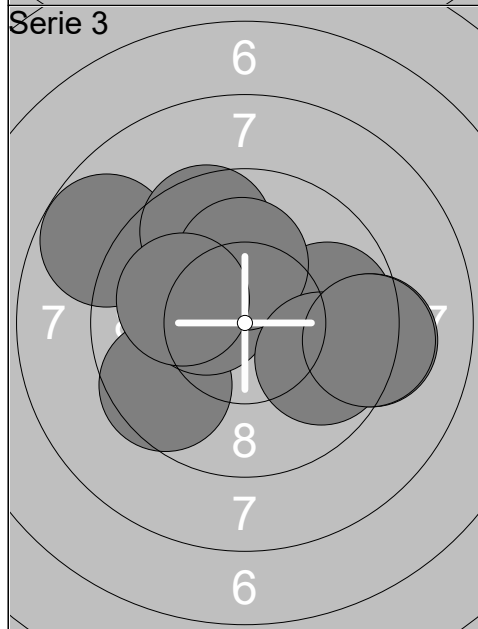

1:	9.8	→
2:	8.8	↖
3:	9.2	→
4:	9.6	↖
5:	9.6	↗
6:	10.4x	↖
7:	10.1	↑
8:	10.0	↖
9:	9.8	↘
10:	9.3	→
<b>Series</b>		<b>96.6</b>
		<b>292.8</b>

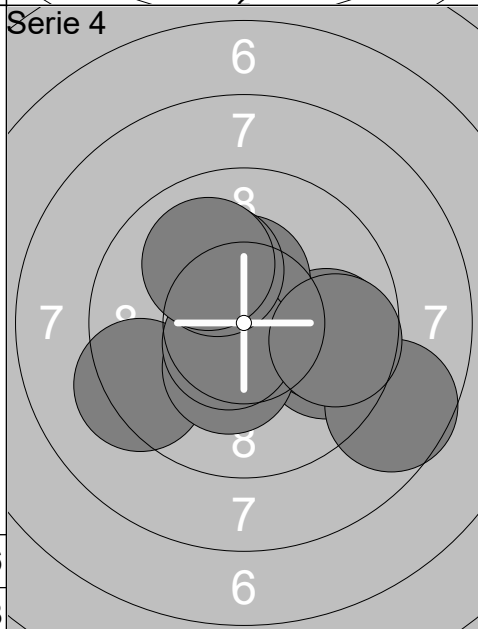

1:	9.7	→
2:	9.3	↖
3:	9.8	→
4:	10.4x	↑
5:	8.6	↘
6:	10.3x	↘
7:	10.6x	↘
8:	10.1	↗
9:	10.0	↗
10:	9.7	→
<b>Series</b>		<b>98.5</b>
		<b>391.3</b>

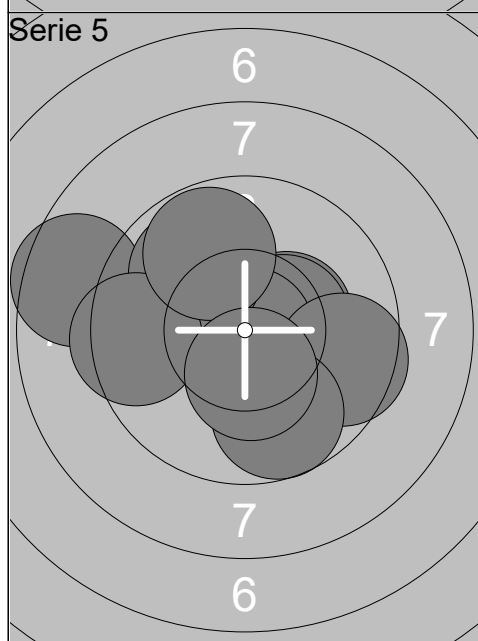

1:	10.4x	→
2:	10.4x	→
3:	10.9x	↘
4:	9.5	→
5:	9.7	↘
6:	8.5	↖
7:	9.9	↗
8:	9.4	↖
9:	9.8	↗
10:	10.3x	↘
<b>Series</b>		<b>98.8</b>
		<b>490.1</b>

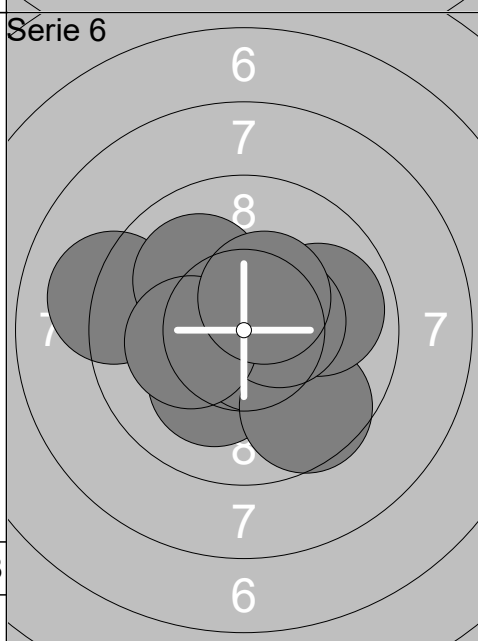

1:	10.8x	↗
2:	9.1	↖
3:	10.1	↘
4:	10.7x	↘
5:	10.0	↗
6:	9.6	↘
7:	9.9	→
8:	10.5x	→
9:	10.2x	↖
10:	10.4x	↗
<b>Series</b>		<b>101.3</b>
		<b>591.4</b>

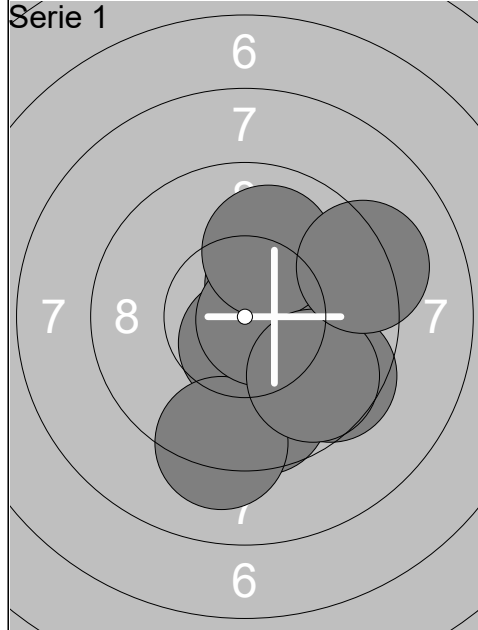

1:	10.4x ↗
2:	9.7 ↓
3:	10.5x →
4:	10.6x ↓
5:	9.2 ↓
6:	10.7x →
7:	9.5 ↘
8:	10.0 ↑
9:	9.7 ↘
10:	9.2 →
<b>Series</b>	<b>99.5</b>
	<b>99.5</b>

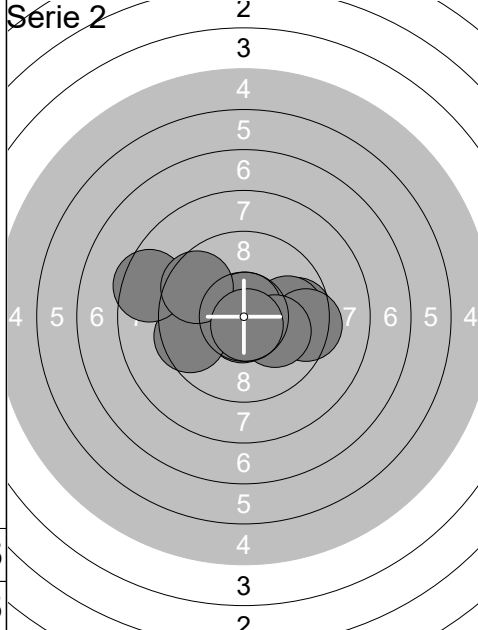

1:	10.7x ↓
2:	9.6 →
3:	9.9 →
4:	10.7x ↑
5:	9.5 ←
6:	9.4 →
7:	8.5 ←
8:	9.6 ↖
9:	10.1 ↗
10:	10.7x ↓
<b>Series</b>	<b>98.7</b>
	<b>198.2</b>

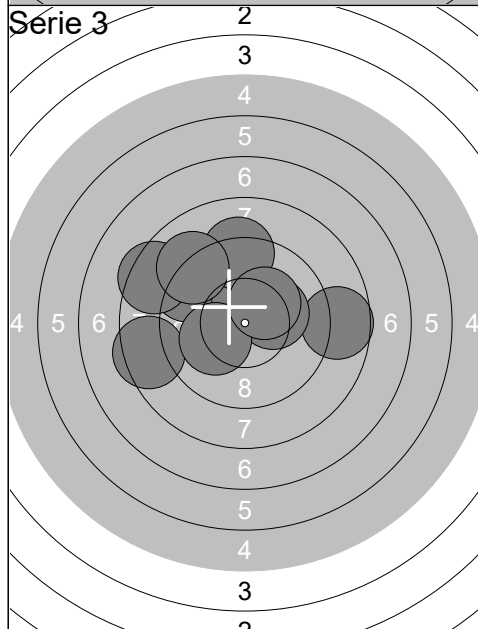

1:	9.3 ↖
2:	8.4 ↖
3:	8.6 →
4:	10.4x ↑
5:	9.2 ↑
6:	8.4 ←
7:	10.2x →
8:	9.1 ↖
9:	10.1 ↖
10:	10.2x ↗
<b>Series</b>	<b>93.9</b>
	<b>292.1</b>

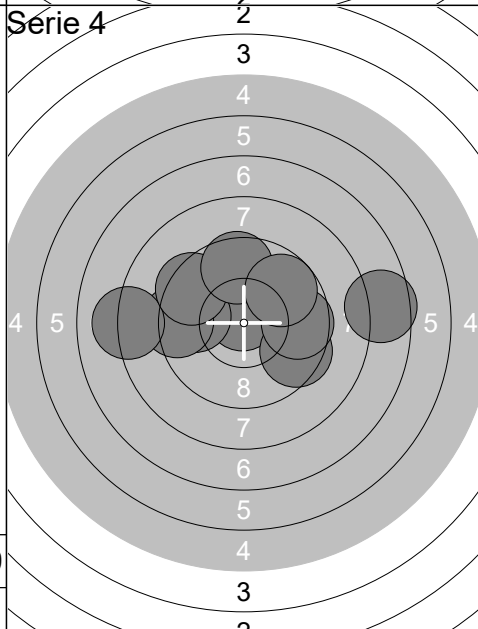

1:	10.7x ↑
2:	7.6 →
3:	9.5 ↘
4:	9.7 ←
5:	9.3 ←
6:	8.1 ←
7:	9.4 ↖
8:	9.5 ↑
9:	9.6 →
10:	9.7 ↗
<b>Series</b>	<b>93.1</b>
	<b>385.2</b>

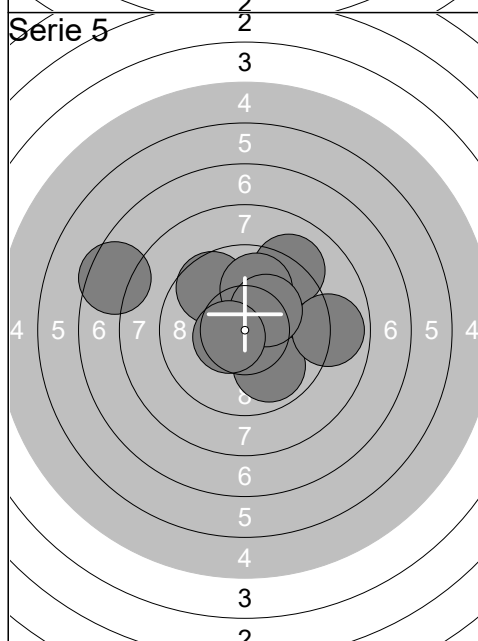

1:	9.1 ↗
2:	10.6x ↘
3:	9.9 ↘
4:	9.9 ↗
5:	9.6 ↗
6:	7.5 ↖
7:	9.9 ↑
8:	8.9 →
9:	10.2x ↗
10:	10.5x ←
<b>Series</b>	<b>96.1</b>
	<b>481.3</b>

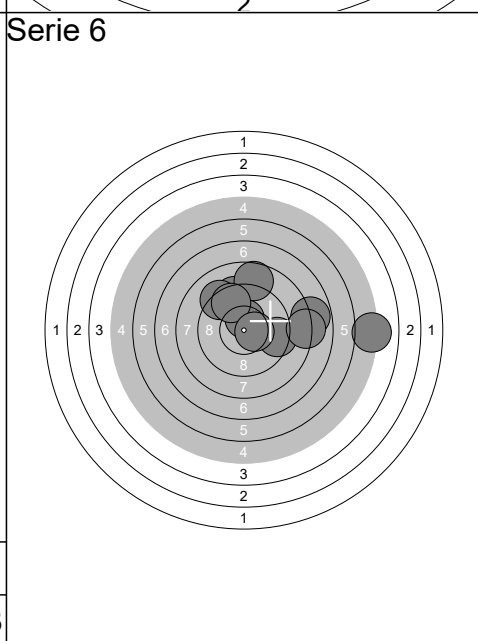

1:	7.8 →
2:	9.3 ↑
3:	5.1 →
4:	9.4 →
5:	9.2 ↗
6:	8.1 →
7:	10.4x ↑
8:	8.6 ↑
9:	9.5 ↖
10:	10.4x →
<b>Series</b>	<b>87.8</b>
	<b>569.1</b>

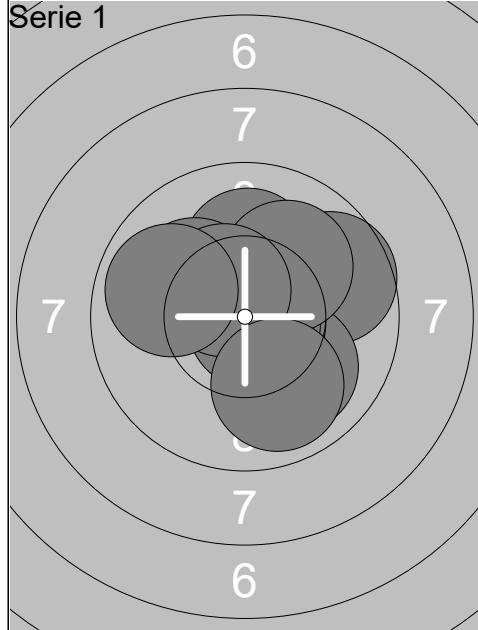

1:	9.7	➔
2:	10.1	↑
3:	10.0	↘
4:	10.7x	➔
5:	10.1	↖
6:	10.8x	↘
7:	10.0	↗
8:	10.5x	↗
9:	9.9	↘
10:	9.9	↖
Series	101.7	
	101.7	

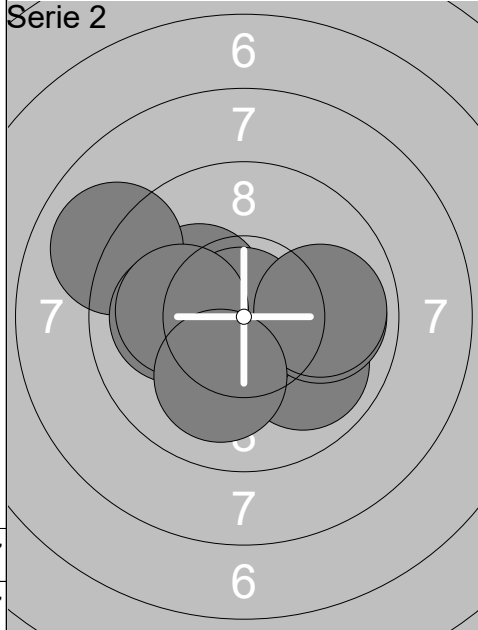

1:	10.2x	↖
2:	9.0	↖
3:	10.0	←
4:	9.9	↘
5:	10.8x	↘
6:	9.9	➔
7:	10.9x	↖
8:	10.1	←
9:	9.9	➔
10:	10.1	↘
Series	100.8	
	202.5	

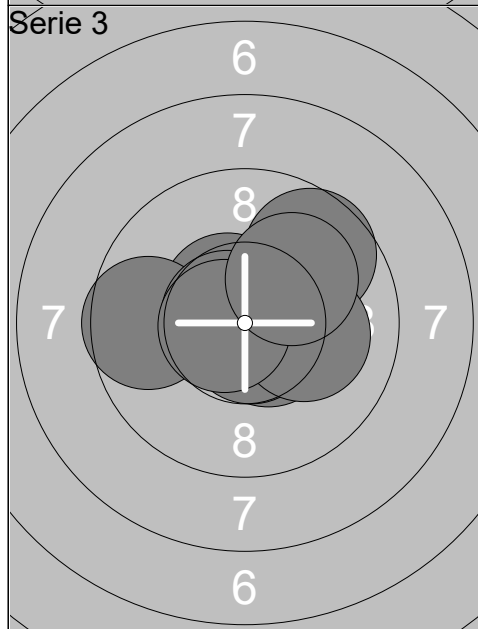

1:	10.5x	↖
2:	10.4x	➔
3:	10.5x	↘
4:	10.7x	↘
5:	9.6	←
6:	10.7x	↖
7:	9.6	↗
8:	10.1	➔
9:	10.6x	↖
10:	10.1	↗
Series	102.8	
	305.3	

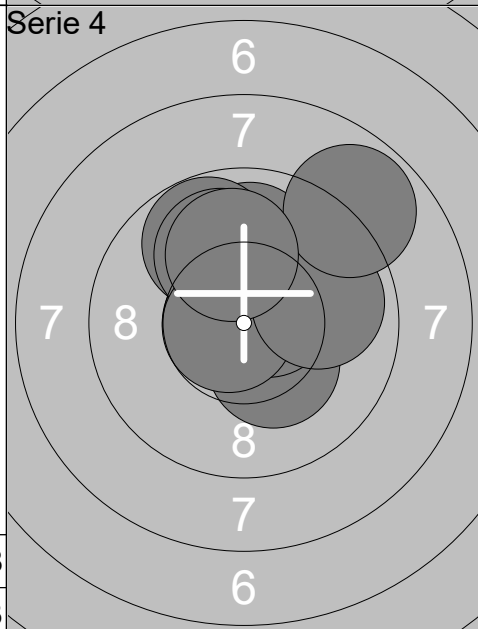

1:	10.3x	↘
2:	10.7x	↖
3:	10.6x	↗
4:	9.9	↑
5:	9.7	↗
6:	10.0	↑
7:	10.7x	↖
8:	9.9	➔
9:	8.8	↗
10:	10.0	↑
Series	100.6	
	405.9	

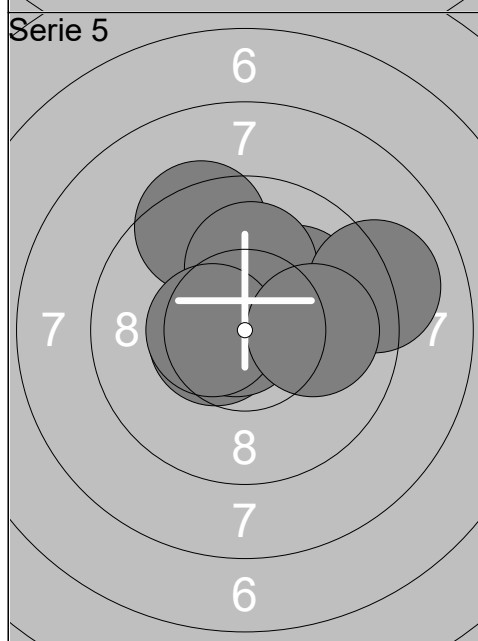

1:	10.2x	↗
2:	10.5x	↖
3:	10.4x	↑
4:	10.8x	↖
5:	10.1	↗
6:	9.4	↗
7:	10.1	↑
8:	9.1	➔
9:	10.5x	↖
10:	10.0	➔
Series	101.1	
	507.0	

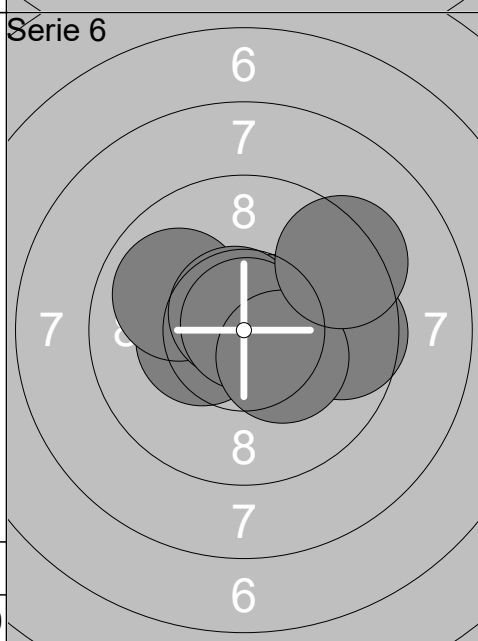

1:	10.3x	↖
2:	10.8x	↗
3:	10.7x	↗
4:	9.9	↖
5:	10.5x	➔
6:	9.6	➔
7:	10.7x	↖
8:	10.9x	↗
9:	10.3x	↘
10:	9.3	↗
Series	103.0	
	610.0	

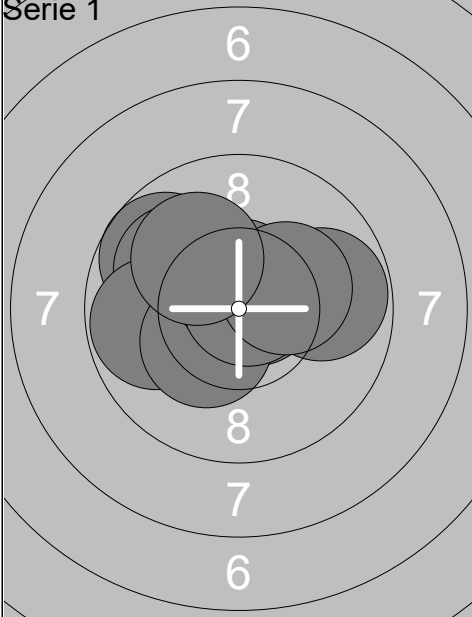
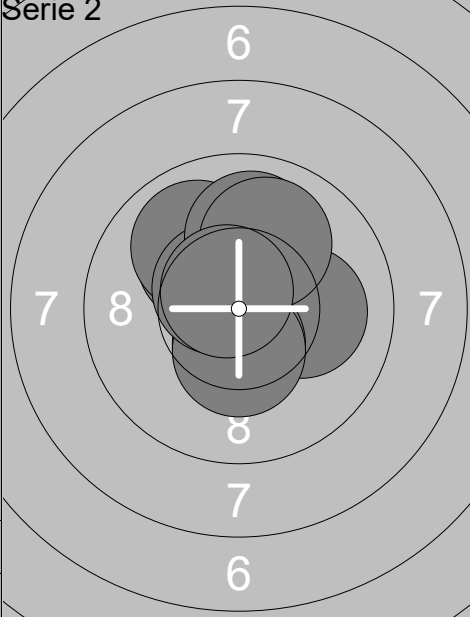
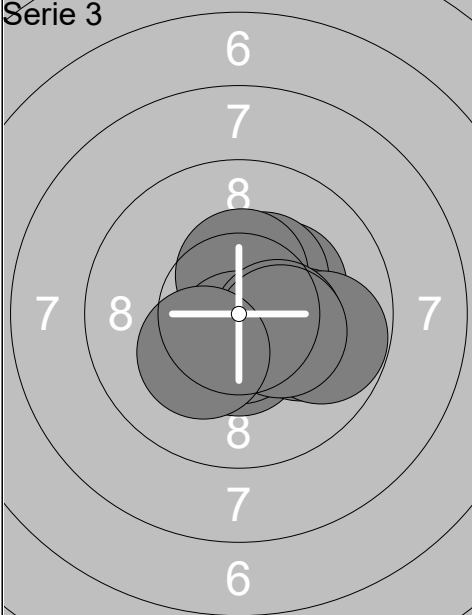
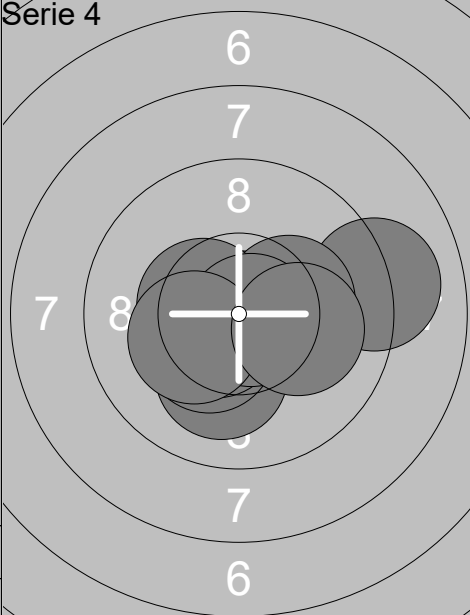
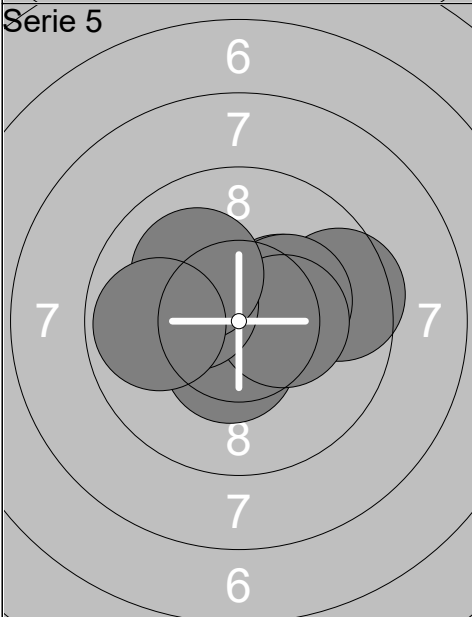
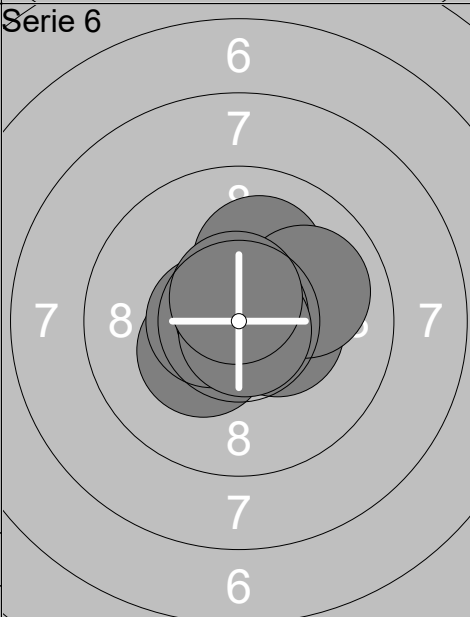

Relay	Lane	Helle Bertelsen	
4	15		
Day 1 Denmark Open Air		Viborg Skytte Forening	WJ
08.03.2019		Day 1 Denmark Open Air	Denmark Open Air
Serie 1		1: 9.9 ↘ 2: 10.5x↙ 3: 10.5x↙ 4: 10.7x↙ 5: 10.0 ← 6: 10.1 → 7: 9.4 → 8: 9.8 ↘ 9: 10.5x↙ 10: 9.6 → Series 101.0 101.0	Serie 2 1: 9.7 → 2: 10.4x ↘ 3: 10.0 ↘ 4: 10.1 ↖ 5: 10.0 → 6: 10.0 ← 7: 10.6x ↗ 8: 10.3x ↖ 9: 9.3 ↘ 10: 10.2x ↘ Series 100.6 201.6
Serie 3		1: 10.0 ← 2: 9.8 ↑ 3: 10.7x ↖ 4: 10.0 ↗ 5: 9.7 ↘ 6: 10.0 ↖ 7: 10.4x ↗ 8: 10.2x → 9: 10.2x → 10: 10.6x ↘ Series 101.6 303.2	Serie 4 1: 10.6x ↗ 2: 10.8x → 3: 9.7 ↗ 4: 10.3x → 5: 10.8x ↑ 6: 9.5 → 7: 10.6x ↘ 8: 9.7 ← 9: 10.0 ← 10: 9.9 ↑ Series 101.9 405.1
Serie 5		1: 10.0 ↘ 2: 10.5x ↘ 3: 9.7 ↘ 4: 10.6x ↙ 5: 10.3x ↘ 6: 9.8 ← 7: 10.2x ↙ 8: 10.0 → 9: 10.4x ↗ 10: 10.5x ↗ Series 102.0 507.1	Serie 6 1: 9.5 ↘ 2: 10.6x ↘ 3: 10.8x → 4: 9.7 ↗ 5: 10.3x ↙ 6: 10.5x ↖ 7: 10.0 ↘ 8: 10.5x → 9: 10.5x ↖ 10: 10.4x ↙ Series 102.8 609.9

Relay	Lane	Caroline Jacobi		
Day 1 Denmark Open Air	Aalborg Skyttekreds	WJ		
08.03.2019	Day 1 Denmark Open Air	Denmark Open Air		
Serie 1		1: 9.7 ↖ 2: 10.0 ↖ 3: 10.7x ↗ 4: 9.8 ← 5: 10.3x ↙ 6: 10.6x ↑ 7: 10.8x ↗ 8: 9.8 → 9: 10.2x ↗ 10: 10.0 ↖ Series 101.9 101.9	Serie 2 	1: 10.1 ↗ 2: 10.1 → 3: 9.9 ↖ 4: 10.5x ↓ 5: 10.4x ↓ 6: 10.6x ↖ 7: 10.5x ↖ 8: 9.9 ↑ 9: 10.0 ↑ 10: 10.6x ↖ Series 102.6 204.5
Serie 3		1: 10.3x ↗ 2: 10.3x ↗ 3: 10.4x ↑ 4: 10.5x ↓ 5: 10.1 → 6: 10.6x ↓ 7: 9.8 → 8: 10.4x → 9: 10.3x → 10: 10.2x ↙ Series 102.9 307.4	Serie 4 	1: 10.1 ↓ 2: 10.9x ↙ 3: 10.3x ↙ 4: 9.0 → 5: 10.5x ↙ 6: 10.2x → 7: 10.4x ← 8: 10.8x → 9: 10.3x ↙ 10: 10.1 → Series 102.6 410.0
Serie 5		1: 10.6x ↙ 2: 10.3x ↗ 3: 9.5 → 4: 10.2x ↗ 5: 10.2x ← 6: 10.4x ↓ 7: 10.3x → 8: 10.2x ← 9: 10.1 ↖ 10: 9.9 ← Series 101.7 511.7	Serie 6 	1: 10.5x ↑ 2: 10.3x ↙ 3: 10.9x ↑ 4: 10.6x ← 5: 10.4x → 6: 10.1 ↑ 7: 10.0 → 8: 10.8x ↗ 9: 10.8x ↘ 10: 10.6x ↑ Series 105.0 616.7

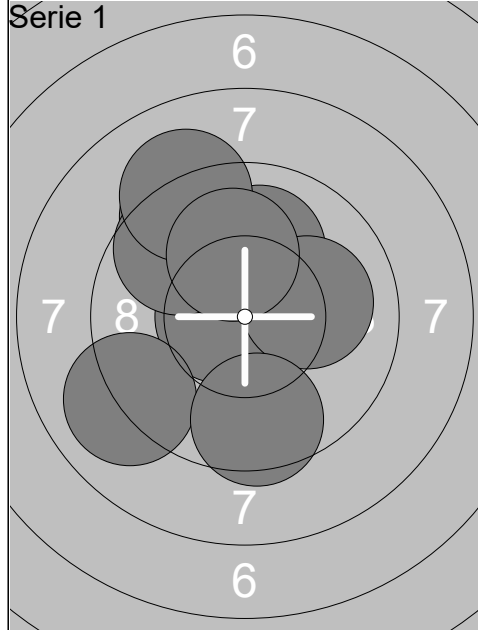

1:	10.3x	↗
2:	10.0	↗
3:	9.4	↗
4:	10.6x	←
5:	10.1	→
6:	9.0	←
7:	9.6	↗
8:	9.1	↗
9:	10.1	↗
10:	9.5	↓
<b>Series</b>	<b>97.7</b>	
	<b>97.7</b>	

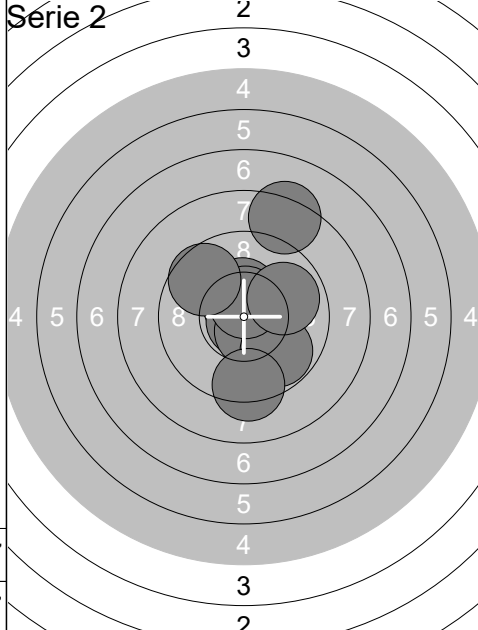

1:	10.6x	↗
2:	10.8x	↓
3:	10.5x	↓
4:	10.4x	↗
5:	9.8	↘
6:	10.6x	↗
7:	9.2	↓
8:	8.3	↗
9:	9.9	↗
10:	9.6	↖
<b>Series</b>	<b>99.7</b>	
	<b>197.4</b>	

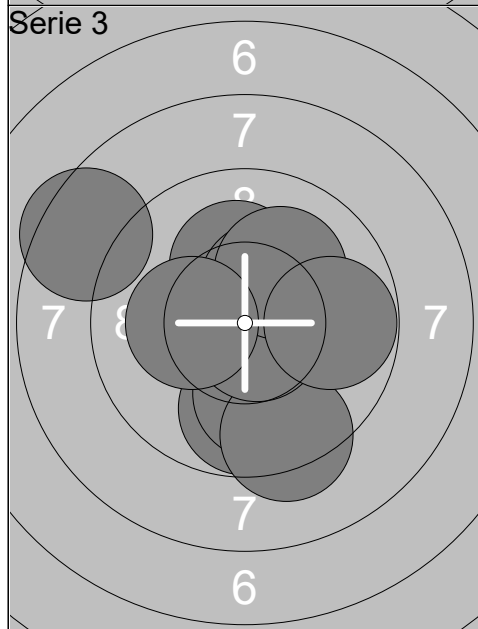

1:	8.5	↖
2:	9.8	↓
3:	10.2x	↗
4:	9.9	↓
5:	9.3	↓
6:	10.4x	↗
7:	10.7x	↘
8:	10.1	↗
9:	10.2x	←
10:	9.8	→
<b>Series</b>	<b>98.9</b>	
	<b>296.3</b>	

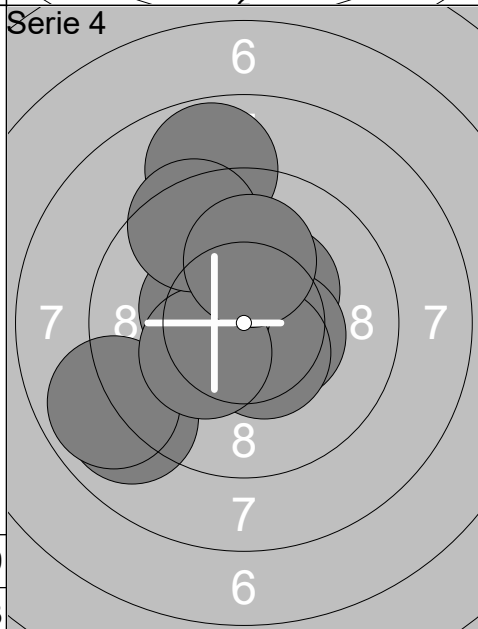

1:	9.0	↖
2:	8.9	↖
3:	10.3x	↗
4:	8.8	↗
5:	10.4x	→
6:	10.4x	↘
7:	10.4x	←
8:	10.2x	↖
9:	9.4	↗
10:	10.1	↗
<b>Series</b>	<b>97.9</b>	
	<b>394.2</b>	

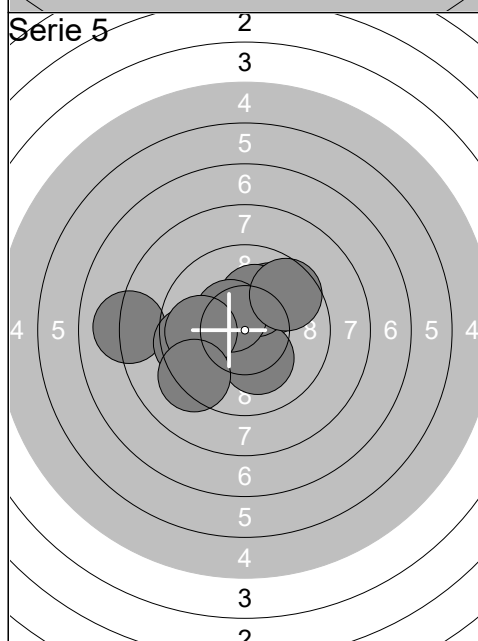

1:	10.7x	←
2:	8.1	←
3:	9.9	↗
4:	9.5	←
5:	10.2x	↘
6:	10.2x	↗
7:	10.4x	↖
8:	9.6	↗
9:	9.9	←
10:	9.3	↖
<b>Series</b>	<b>97.8</b>	
	<b>492.0</b>	

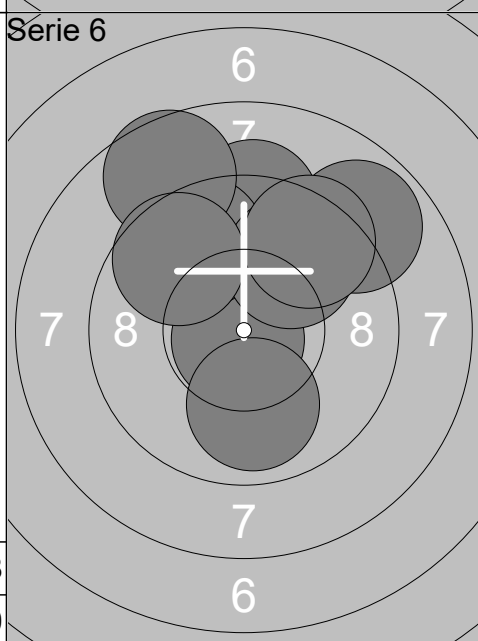

1:	9.7	↗
2:	10.8x	↖
3:	9.9	↓
4:	9.3	↗
5:	9.6	↗
6:	8.6	↗
7:	8.8	↗
8:	9.8	↗
9:	9.6	↖
10:	9.5	↗
<b>Series</b>	<b>95.6</b>	
	<b>587.6</b>	

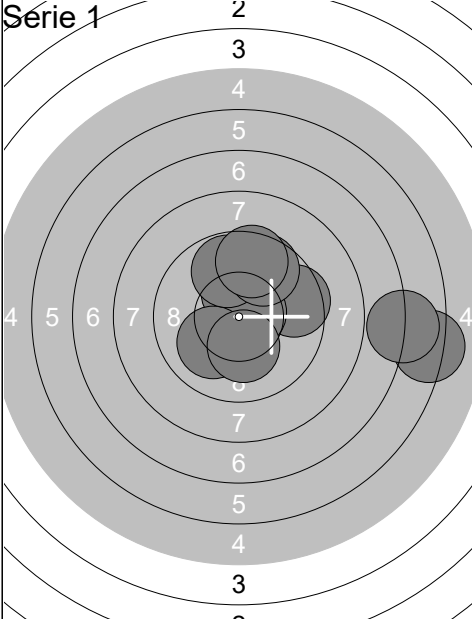
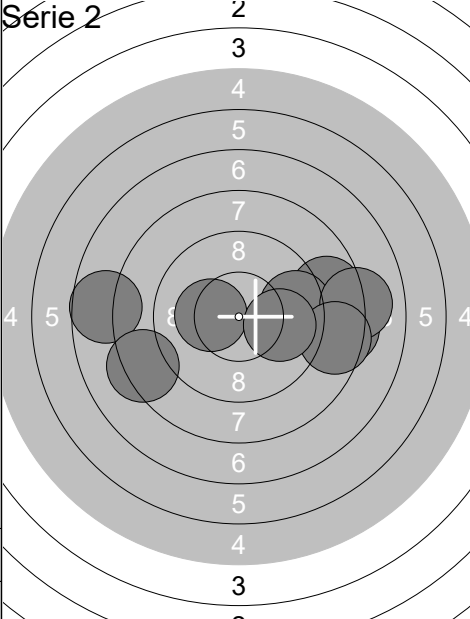
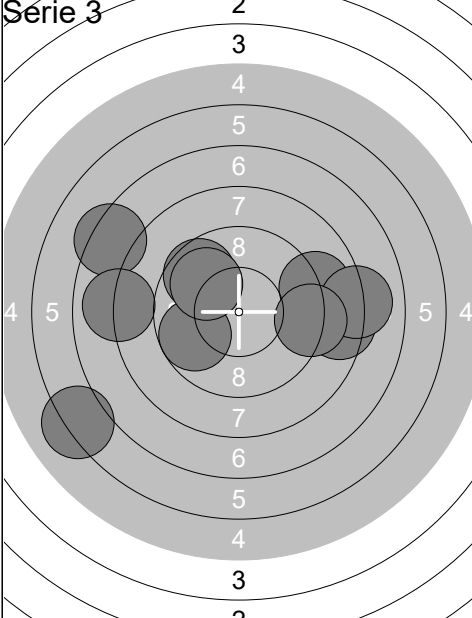
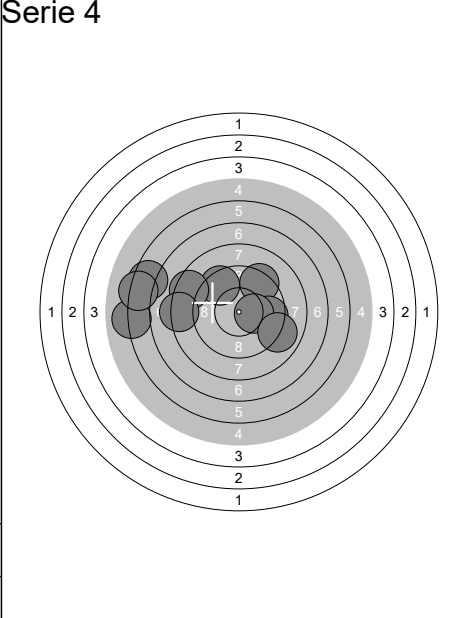
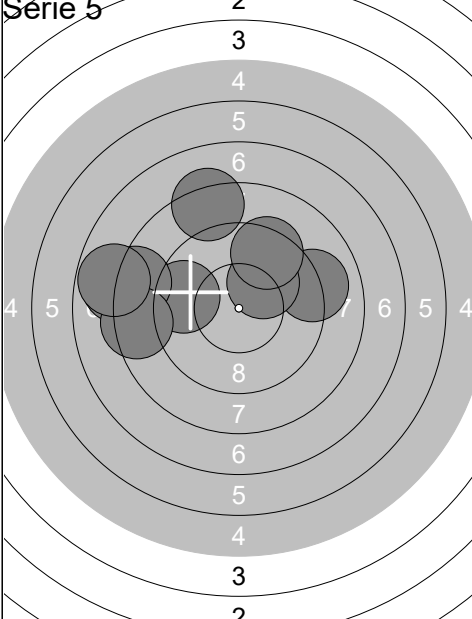
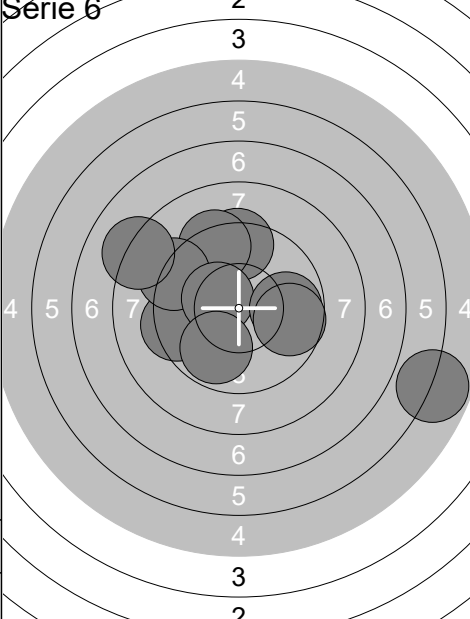
Relay	Lane	Rikke Bertelsen		
Day 1 Denmark Open Air	Viborg Skytte Forening	WJ		
08.03.2019	Day 1 Denmark Open Air	Denmark Open Air		
Série 1		1: 10.3x ↑ 2: 9.5 → 3: 6.2 → 4: 10.6x → 5: 10.0 ↙ 6: 9.8 ↑ 7: 6.9 → 8: 10.2x ↓ 9: 9.6 ↗ 10: 9.5 ↑ Series 92.6 92.6	Série 2 	1: 8.3 → 2: 8.7 → 3: 7.7 ← 4: 9.4 → 5: 9.5 → 6: 8.0 → 7: 10.3x ← 8: 8.3 ↙ 9: 8.5 → 10: 9.9 → Series 88.6 181.2
Série 3		1: 9.6 ↖ 2: 6.1 ↙ 3: 8.4 → 4: 9.0 → 5: 9.7 ↙ 6: 7.3 ↖ 7: 8.0 → 8: 9.9 ↗ 9: 7.9 ← 10: 9.2 → Series 85.1 266.3	Série 4 	1: 9.3 ↗ 2: 9.5 ↗ 3: 9.6 → 4: 6.0 ← 5: 8.4 ↖ 6: 10.3x → 7: 6.5 ↖ 8: 8.9 ↘ 9: 6.2 ← 10: 8.2 ← Series 82.9 349.2
Série 5		1: 8.3 ↑ 2: 8.6 ← 3: 9.6 ← 4: 9.0 → 5: 10.0 ↗ 6: 9.4 ↗ 7: 7.9 ← 8: 8.3 ← 9: 8.4 ← 10: 7.8 ← Series 87.3 436.5	Série 6 	1: 9.4 ↑ 2: 9.4 ← 3: 9.3 ↗ 4: 9.1 ↖ 5: 10.4x ↖ 6: 9.8 → 7: 8.1 ↖ 8: 5.8 ↘ 9: 9.7 → 10: 9.8 ↓ Series 90.8 527.3