

Relay	Lane	Anders Sjöbergh		
3	1	Helsingborgs Sportskytteklubb		Mp
Day 2 Denmark Open Air	15.02.2020	Day 2 Denmark Open Air 2020	Denmark Open Air 2020	
Serie 1		1: 9.3 ↘	Serie 2	1: 10.7x ←
		2: 10.3 ←		2: 9.1 ↘
		3: 9.8 ↘		3: 10.2 ↗
		4: 8.6 ↗	4: 9.1 ←	
		5: 10.8x ↑	5: 10.2 ↗	
		6: 8.7 →	6: 10.5x ↘	
		7: 10.2 ↘	7: 9.5 ←	
		8: 10.2 ↘	8: 6.7 ↘	
		9: 9.2 →	9: 9.0 ←	
		10: 8.1 ↘	10: 8.0 →	
	Series 91 ( 1x)		Series 90 ( 2x)	
	91 ( 1x)		181 ( 3x)	
Serie 3		1: 8.3 ↗	Serie 4	1: 9.7 ←
		2: 10.4x ↗		2: 7.8 ↗
		3: 10.2 →		3: 6.5 →
		4: 8.4 ↗	4: 10.0 ↗	
		5: 9.2 ↗	5: 7.2 ↗	
		6: 8.2 ↘	6: 8.5 ←	
		7: 7.2 ↗	7: 8.3 ↘	
		8: 8.6 ↘	8: 9.9 ↘	
		9: 6.8 →	9: 7.1 ↗	
		10: 9.6 ↘	10: 8.1 ←	
	Series 83 ( 1x)		Series 79 ( 0x)	
	264 ( 4x)		343 ( 4x)	
Serie 5		1: 10.7x ↘	Serie 6	1: 9.1 →
		2: 10.0 →		2: 8.8 ↗
		3: 9.4 ←		3: 8.6 ↘
		4: 9.4 ↗	4: 8.2 →	
		5: 10.0 ←	5: 7.4 ↗	
		6: 9.4 →	6: 8.6 ↗	
		7: 9.7 ↘	7: 8.3 ↗	
		8: 8.5 ↗	8: 9.8 ↗	
		9: 8.2 ↗	9: 8.0 ↘	
		10: 8.4 ↘	10: 10.5x ←	
	Series 90 ( 1x)		Series 83 ( 1x)	
	433 ( 5x)		516 ( 6x)	

Relay <b>3</b>	Lane <b>2</b>	<b>Malik Bazara</b>	
Day 2 Denmark Open Air		Helsingør Salonskytte Forening	Mp
15.02.2020		Day 2 Denmark Open Air 2020	Denmark Open Air 2020
Serie 1 	1: 8.7 →	Serie 2 	1: 9.0 ↖
	2: 9.8 →		2: 9.1 ↙
	3: 10.1 ↗		3: 10.4x →
	4: 9.4 ↗		4: 8.0 ↖
	5: 9.7 ←		5: 10.4x ↗
	6: 9.7 ↗		6: 9.8 ↖
	7: 9.0 →		7: 9.8 ↗
	8: 9.9 ↑		8: 10.5x →
	9: 8.8 ↖		9: 9.6 ↖
	10: 10.9x →		10: 10.3 ↑
	Series 90 ( 1x)		Series 93 ( 3x)
	90 ( 1x)		183 ( 4x)
Serie 3 	1: 9.7 ↘	Serie 4 	1: 9.1 ←
	2: 10.2 ←		2: 9.8 ↘
	3: 8.0 ←		3: 10.3 ↘
	4: 9.4 ↘		4: 10.4x ←
	5: 10.5x ↘		5: 9.7 ↘
	6: 9.3 ←		6: 9.6 ↘
	7: 10.7x ←		7: 9.4 ↑
	8: 9.3 ↖		8: 8.8 ↑
	9: 8.0 ←		9: 9.7 ↗
	10: 9.4 ←		10: 8.9 ↑
	Series 91 ( 2x)		Series 90 ( 1x)
	274 ( 6x)		364 ( 7x)
Serie 5 	1: 10.0 →	Serie 6 	1: 9.8 →
	2: 10.3 →		2: 9.8 ↖
	3: 9.7 ↘		3: 9.6 ↘
	4: 9.3 ↖		4: 9.8 →
	5: 10.5x →		5: 9.6 ↘
	6: 8.9 ↑		6: 9.9 ↘
	7: 8.9 ↘		7: 10.0 ↗
	8: 10.5x →		8: 8.3 ↖
	9: 9.7 ↘		9: 8.8 ↖
	10: 10.0 ↘		10: 10.4x ←
	Series 93 ( 2x)		Series 90 ( 1x)
	457 ( 9x)		547 ( 10x)

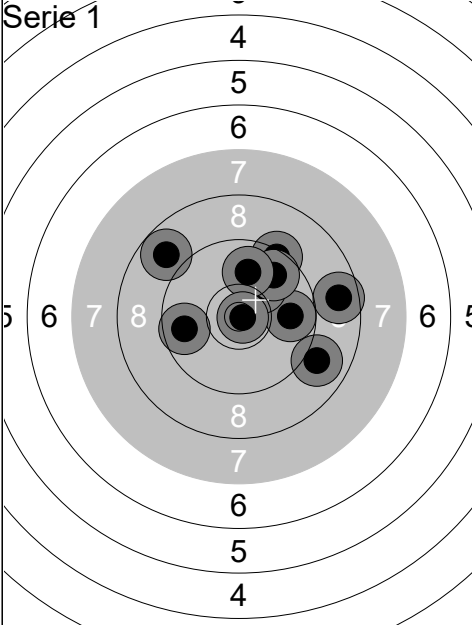

1:	9.6	↗
2:	9.6	↖
3:	10.5x	↗
4:	10.3	↘
5:	9.9	↖
6:	10.6x	↘
7:	8.7	↘
8:	10.2	→
9:	8.5	↘
10:	9.6	↘
<b>Series</b>	<b>92 ( 2x)</b>	
	<b>92 ( 2x)</b>	

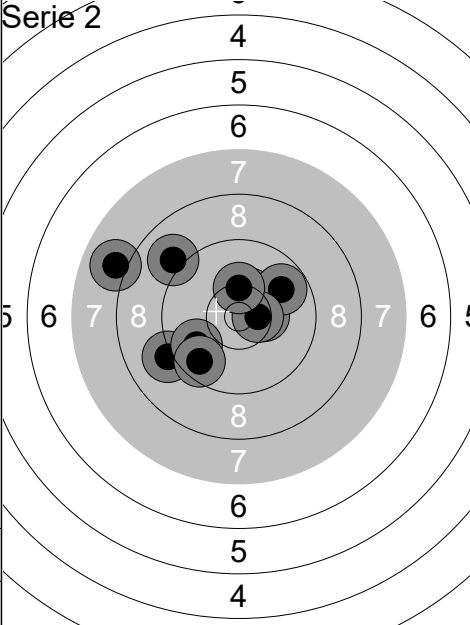
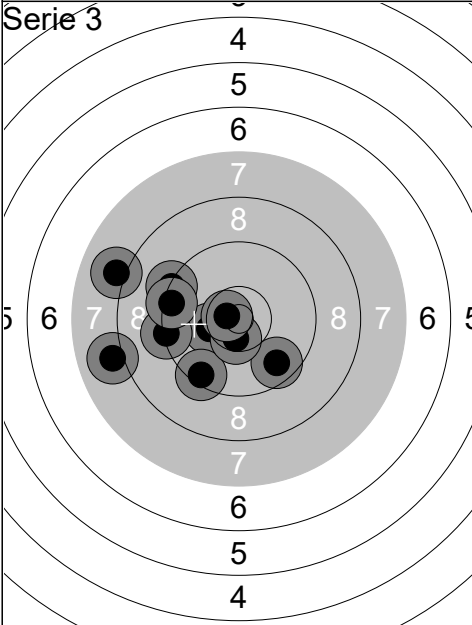
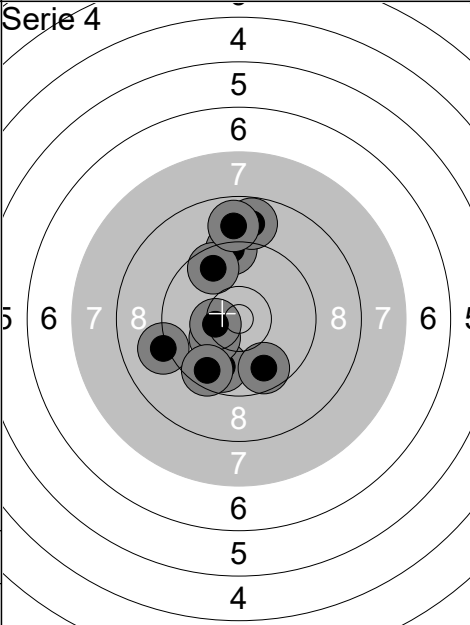
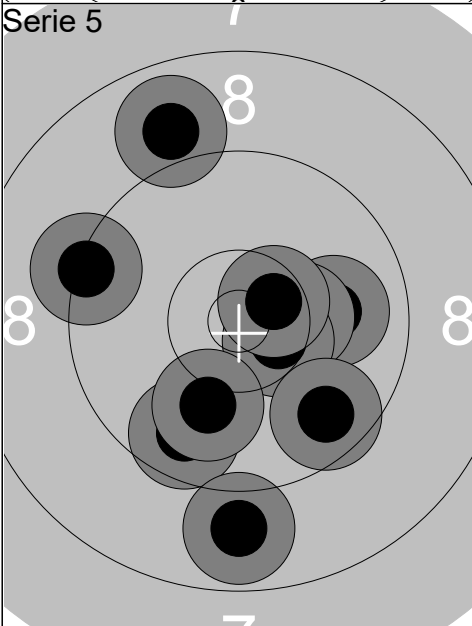
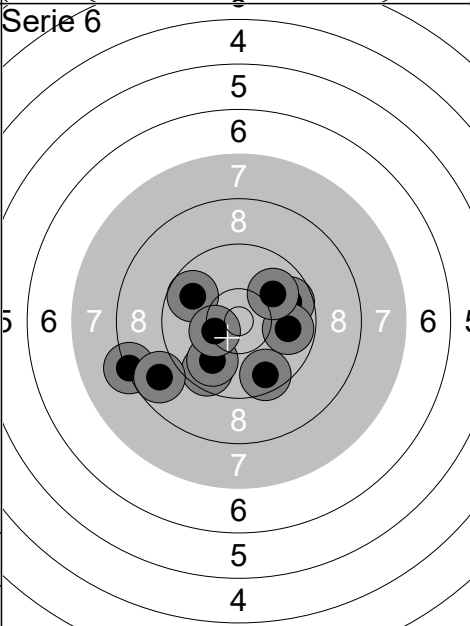
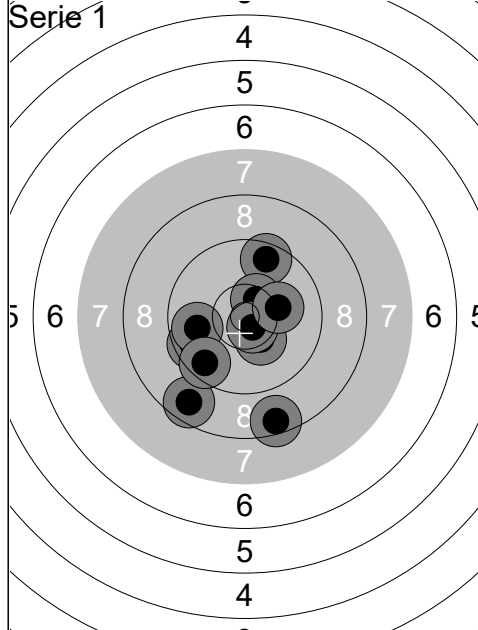
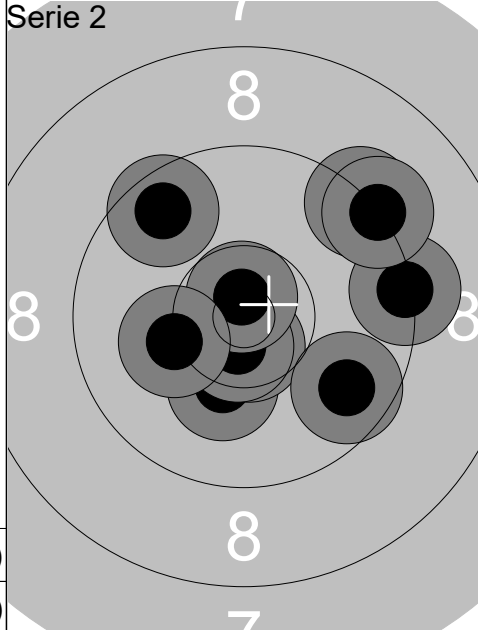

1:	10.2	↘
2:	9.3	→
3:	10.6x	↘
4:	9.3	↗
5:	10.6x	↘
6:	10.7x	↗
7:	9.2	↗
8:	9.7	↘
9:	9.6	↖
10:	10.2	↖
<b>Series</b>	<b>95 ( 3x)</b>	
	<b>187 ( 5x)</b>	

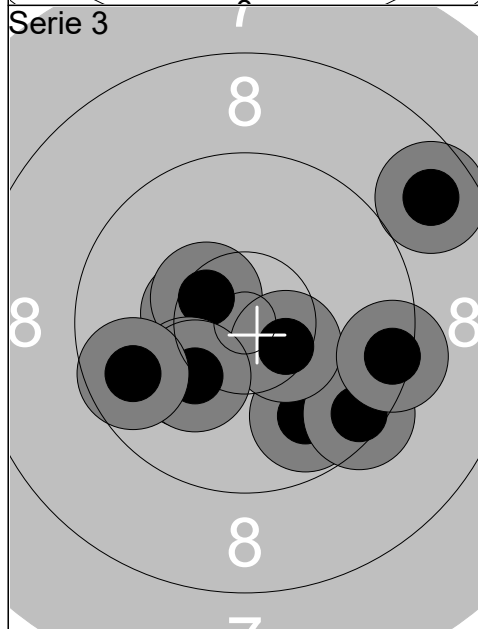

1:	10.4x	↖
2:	10.5x	↖
3:	8.7	↗
4:	9.8	↘
5:	9.5	↘
6:	10.5x	↘
7:	9.4	→
8:	10.2	↖
9:	10.2	↖
10:	9.7	↖
<b>Series</b>	<b>94 ( 3x)</b>	
	<b>281 ( 8x)</b>	

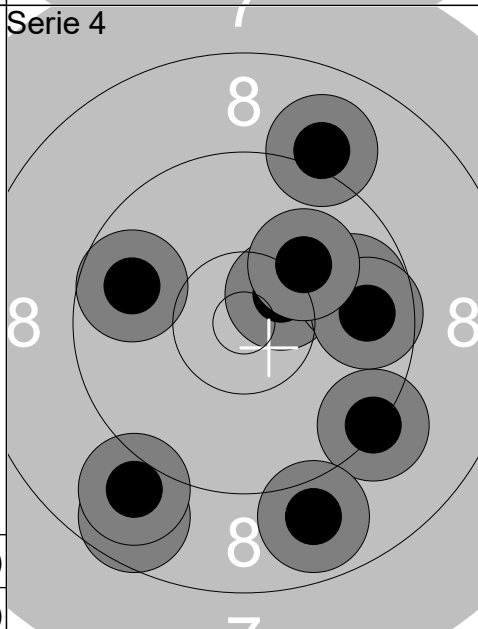

1:	8.7	↘
2:	10.5x	↗
3:	9.0	↗
4:	9.3	↘
5:	9.8	→
6:	9.8	↖
7:	8.9	↘
8:	8.9	↘
9:	9.7	→
10:	10.1	↗
<b>Series</b>	<b>89 ( 1x)</b>	
	<b>370 ( 9x)</b>	

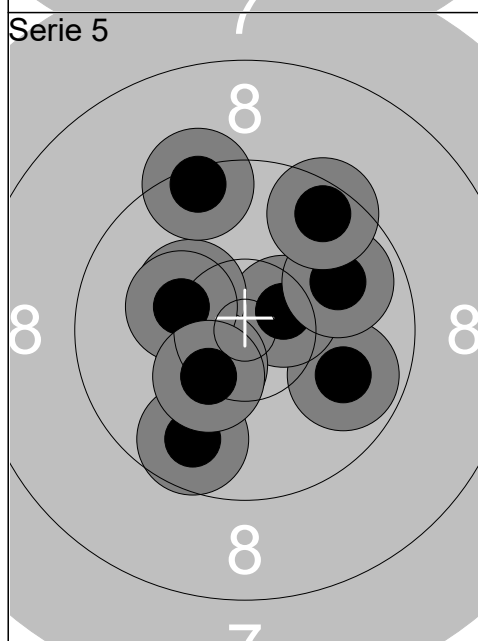

1:	9.7	↘
2:	9.9	↘
3:	10.5x	↗
4:	10.3	↖
5:	9.9	↗
6:	9.4	↗
7:	9.5	↗
8:	10.5x	↖
9:	10.3	↖
10:	10.4	↘
<b>Series</b>	<b>95 ( 2x)</b>	
	<b>465 (11x)</b>	

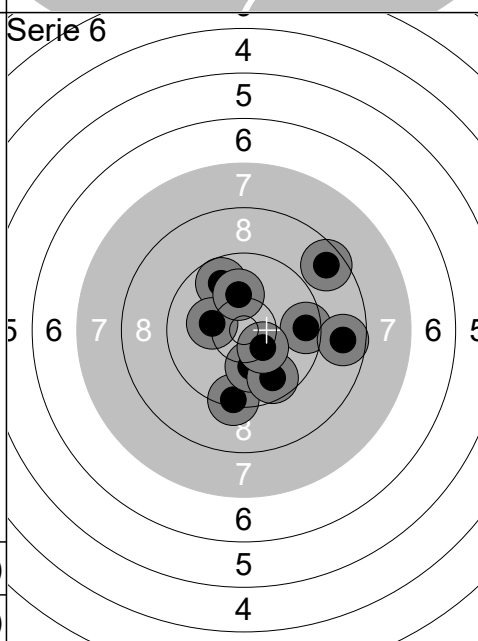

1:	9.4	↘
2:	9.6	→
3:	10.1	↘
4:	8.6	↗
5:	9.8	↗
6:	9.7	↘
7:	10.2	↖
8:	10.1	↗
9:	8.7	→
10:	10.4x	↘
<b>Series</b>	<b>92 ( 1x)</b>	
	<b>557 (12x)</b>	

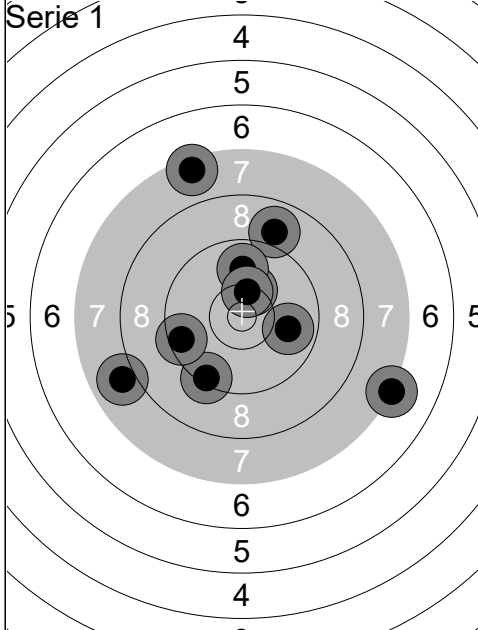

1:	10.3	↗
2:	7.5	↖
3:	7.9	↖
4:	9.4	↘
5:	7.2	↗
6:	9.5	↖
7:	8.9	↗
8:	9.9	↗
9:	9.9	↗
10:	10.4x	↗
<b>Series</b>		<b>85 ( 1x)</b>
		<b>85 ( 1x)</b>

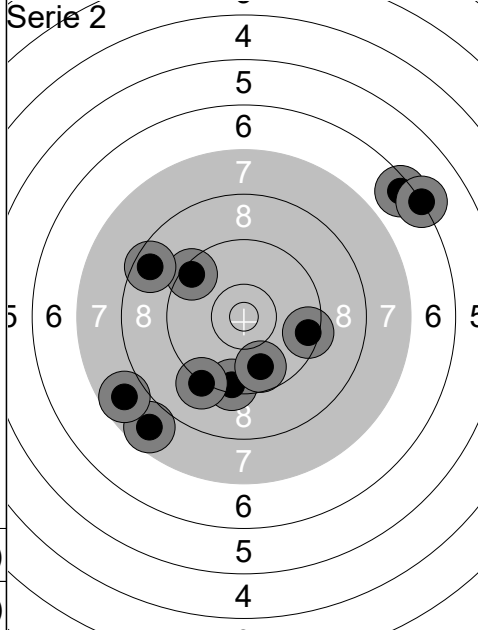

1:	6.5	↗
2:	9.4	↖
3:	7.7	↘
4:	6.2	↗
5:	9.4	↘
6:	9.5	↗
7:	9.8	↘
8:	8.6	↖
9:	9.2	↘
10:	7.7	↖
<b>Series</b>		<b>79 ( 0x)</b>
		<b>164 ( 1x)</b>

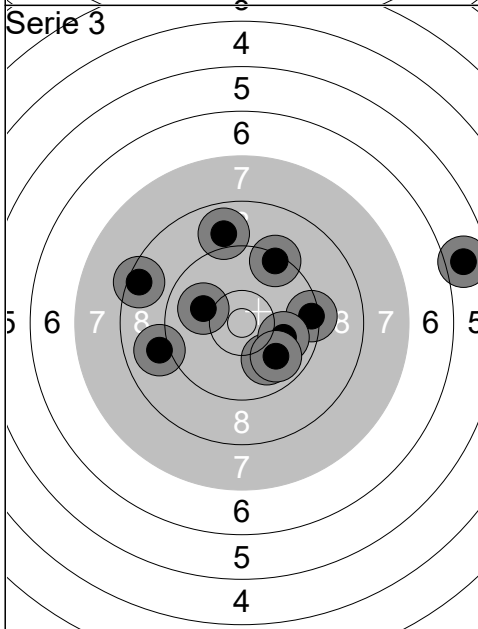

1:	9.4	↗
2:	10.0	↖
3:	10.0	↘
4:	10.0	↗
5:	9.9	↘
6:	9.4	↗
7:	9.0	↖
8:	5.8	↗
9:	8.5	↖
10:	8.9	↗
<b>Series</b>		<b>87 ( 0x)</b>
		<b>251 ( 1x)</b>

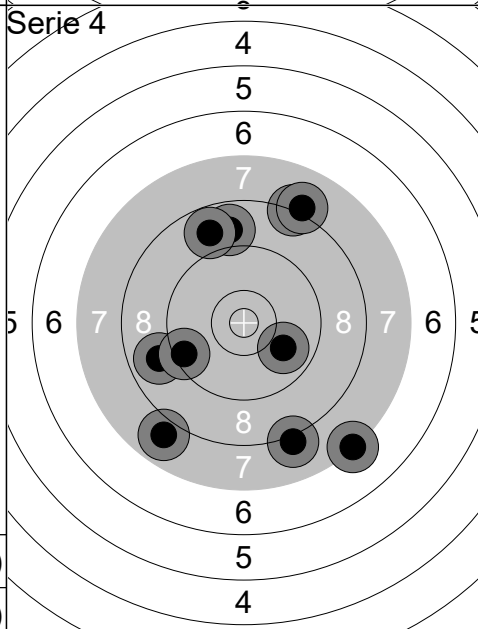

1:	8.9	↗
2:	8.9	↖
3:	8.2	↗
4:	9.9	↘
5:	8.8	↗
6:	7.3	↘
7:	8.1	↗
8:	7.9	↘
9:	9.4	↖
10:	8.1	↘
<b>Series</b>		<b>80 ( 0x)</b>
		<b>331 ( 1x)</b>

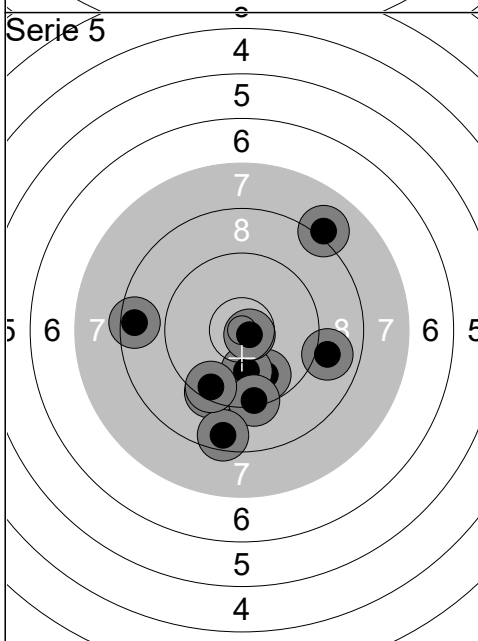

1:	8.1	↗
2:	8.6	↖
3:	9.4	↘
4:	9.8	↘
5:	10.0	↘
6:	9.4	↘
7:	10.8x	↘
8:	8.6	↘
9:	9.5	↘
10:	9.0	↗
<b>Series</b>		<b>89 ( 1x)</b>
		<b>420 ( 2x)</b>

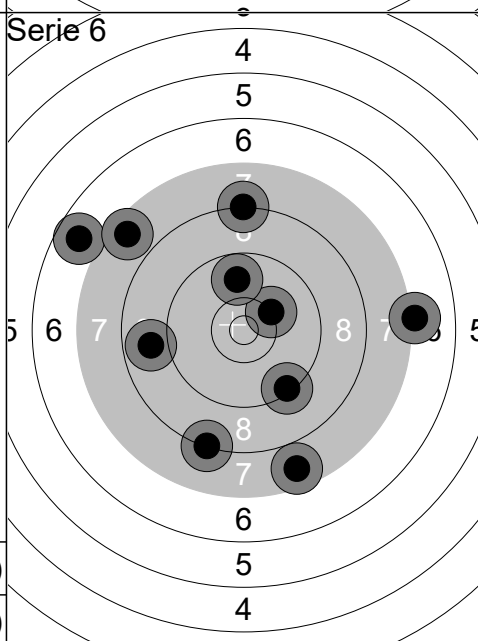

1:	9.3	↘
2:	6.8	↖
3:	7.1	↗
4:	8.9	↖
5:	10.2	↗
6:	7.6	↗
7:	7.6	↘
8:	8.2	↗
9:	8.2	↘
10:	9.8	↗
<b>Series</b>		<b>79 ( 0x)</b>
		<b>499 ( 2x)</b>

Relay	Lane	Frederik Larsen		
Day 2 Denmark Open Air	DSB/ASF	Mp		
15.02.2020	Day 2 Denmark Open Air 2020	Denmark Open Air 2020		
Serie 1 	1: 9.9 ←	Serie 2 	1: 9.9 ←	
	2: 10.0 ↓		2: 10.0 →	
	3: 9.3 ↓		3: 10.6x ↓	
	4: 9.9 ↖		4: 10.5x →	
	5: 9.8 ↓		5: 10.2 ↑	
	6: 9.5 →		6: 9.9 ↙	
	7: 9.7 ↓		7: 10.6x →	
	8: 9.0 ←		8: 10.1 ←	
	9: 10.7x ↓		9: 10.0 ↓	
	10: 10.2 →		10: 10.2 ←	
	Series 93 ( 1x)		Series 98 ( 3x)	
	93 ( 1x)		191 ( 4x)	
Serie 3 	1: 10.2 ↓	Serie 4 	1: 10.0 ↙	
	2: 10.3 ↓		2: 10.3 ↓	
	3: 10.8x ↑		3: 9.9 ↗	
	4: 9.4 ←		4: 9.5 ↖	
	5: 10.6x →		5: 9.4 ↑	
	6: 9.9 ↙		6: 10.1 ↑	
	7: 10.0 ↓		7: 10.0 ↙	
	8: 10.6x ↑		8: 10.4x ↙	
	9: 9.5 ↑		9: 9.9 ↗	
	10: 9.9 ←		10: 10.0 ↙	
	Series 96 ( 3x)		Series 96 ( 1x)	
	287 ( 7x)		383 ( 8x)	
Serie 5 	1: 10.1 ↗	Serie 6 	1: 10.3 →	
	2: 10.9x ↖		2: 10.1 ←	
	3: 10.3 ←		3: 10.7x →	
	4: 10.6x ↖		4: 9.8 ↓	
	5: 10.1 ↗		5: 10.6x ↓	
	6: 10.0 ←		6: 9.4 ↙	
	7: 10.6x ↙		7: 9.4 ↓	
	8: 10.1 ←		8: 10.4x ↙	
	9: 10.2 ←		9: 9.1 ↗	
	10: 10.1 ↗		10: 9.7 ↗	
	Series 100 ( 3x)		Series 95 ( 3x)	
	483 (11x)		578 (14x)	

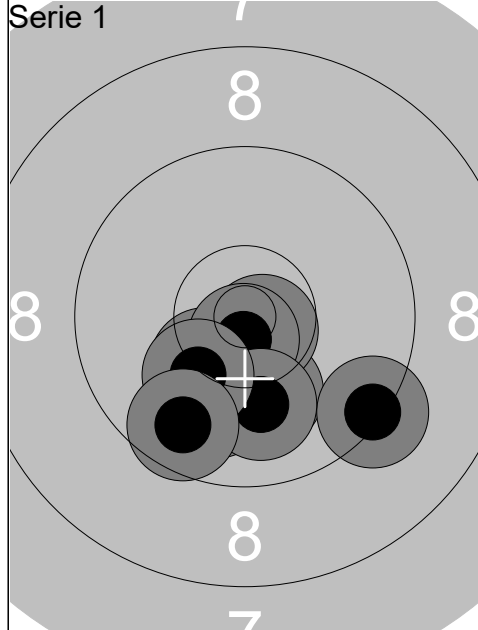

1:	10.1	↓
2:	10.3	↙
3:	10.0	↓
4:	10.2	↓
5:	10.7x	↘
6:	9.3	↘
7:	10.7x	↓
8:	10.0	↓
9:	10.2	↙
10:	9.7	↙
<b>Series</b>	<b>98</b>	<b>( 2x)</b>
	<b>98</b>	<b>( 2x)</b>

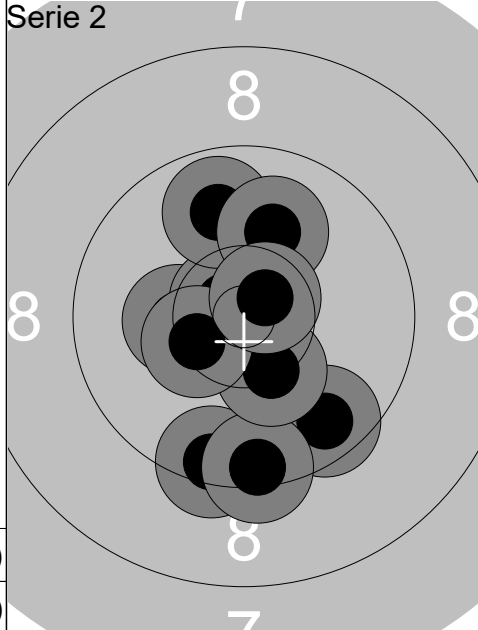

1:	10.3	←
2:	9.4	↓
3:	9.6	↘
4:	9.4	↓
5:	10.7x	↘
6:	10.3	↓
7:	9.9	↑
8:	10.0	↑
9:	10.4x	↙
10:	10.7x	↗
<b>Series</b>	<b>96</b>	<b>( 3x)</b>
	<b>194</b>	<b>( 5x)</b>

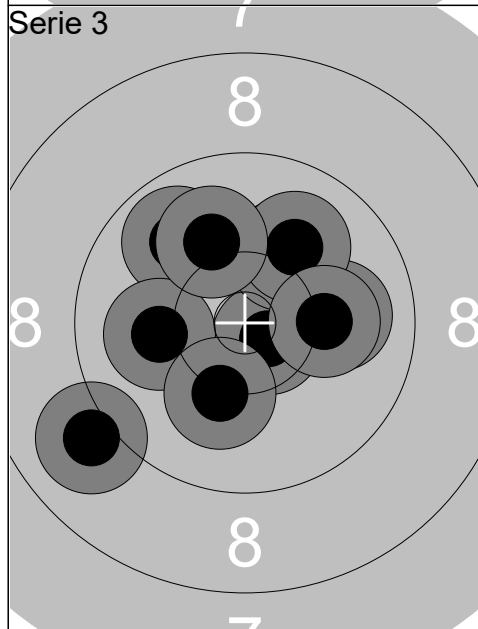

1:	10.7x	↘
2:	9.9	↗
3:	10.1	←
4:	10.0	→
5:	10.2	↗
6:	10.2	↓
7:	10.0	↗
8:	9.0	←
9:	10.1	→
10:	10.1	↗
<b>Series</b>	<b>98</b>	<b>( 1x)</b>
	<b>292</b>	<b>( 6x)</b>

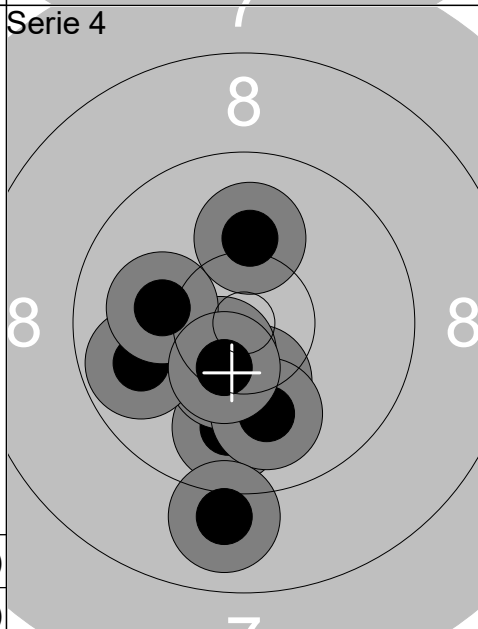

1:	10.4	↓
2:	9.9	↓
3:	10.4x	↙
4:	10.0	↓
5:	10.6x	↙
6:	9.8	←
7:	10.1	←
8:	10.1	↑
9:	10.4x	↙
10:	9.0	↓
<b>Series</b>	<b>97</b>	<b>( 3x)</b>
	<b>389</b>	<b>( 9x)</b>

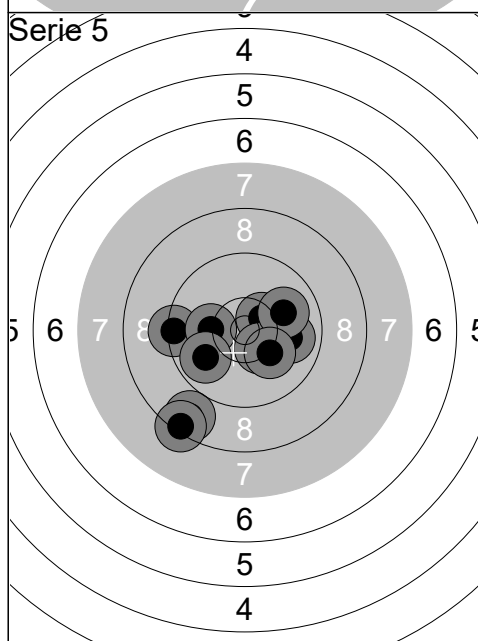

1:	9.9	→
2:	9.4	←
3:	10.2	←
4:	9.9	↙
5:	8.7	↙
6:	10.5x	↗
7:	10.4x	↘
8:	10.0	↗
9:	10.2	↘
10:	8.4	↙
<b>Series</b>	<b>93</b>	<b>( 2x)</b>
	<b>482</b>	<b>(11x)</b>

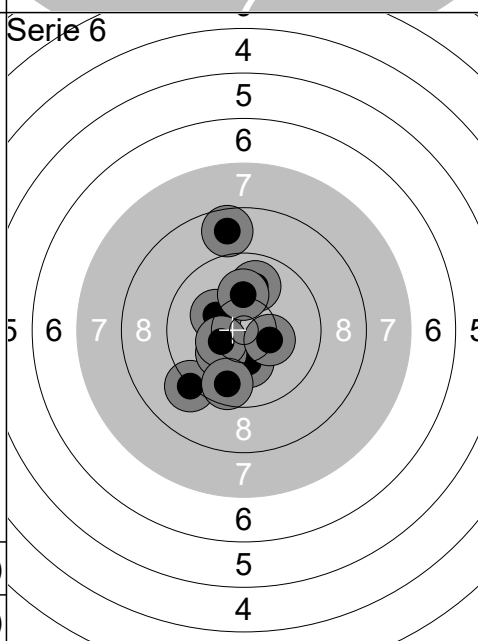

1:	9.2	↙
2:	10.2	↖
3:	10.2	↓
4:	9.9	↑
5:	10.2	↑
6:	10.2	↙
7:	10.4x	↙
8:	8.7	↑
9:	9.7	↓
10:	10.3	→
<b>Series</b>	<b>95</b>	<b>( 1x)</b>
	<b>577</b>	<b>(12x)</b>

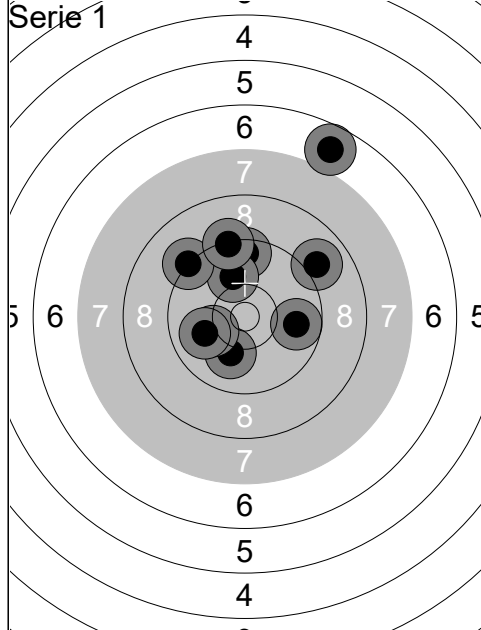

1:	6.8	↗
2:	9.5	↑
3:	9.0	↗
4:	10.1	↘
5:	10.0	↑
6:	10.2	←
7:	9.2	↖
8:	9.8	→
9:	9.3	↑
10:	10.0	←
<b>Series</b>	<b>91 ( 0x)</b>	
	<b>91 ( 0x)</b>	

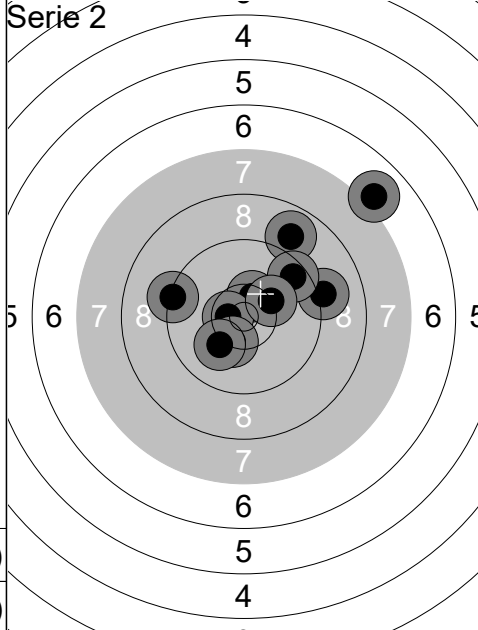

1:	10.4x	↗
2:	9.1	→
3:	9.3	←
4:	8.9	↗
5:	9.5	↗
6:	10.6x	←
7:	10.3	↘
8:	10.1	↘
9:	10.2	↗
10:	7.0	↗
<b>Series</b>	<b>92 ( 2x)</b>	
	<b>183 ( 2x)</b>	

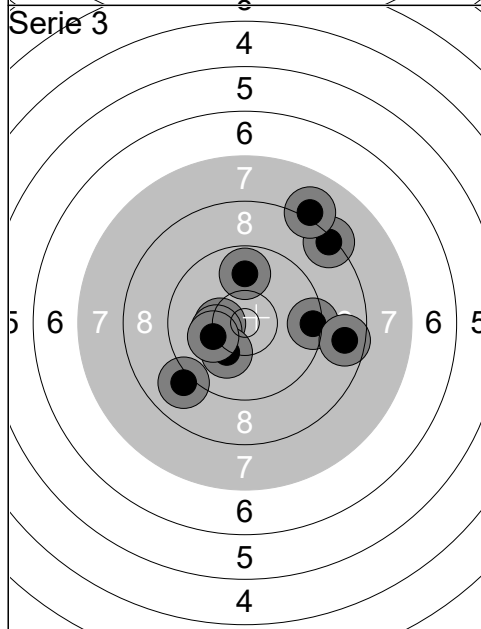

1:	10.4x	←
2:	9.4	→
3:	8.3	↗
4:	9.0	↘
5:	8.1	↗
6:	9.8	↑
7:	8.7	→
8:	10.3	←
9:	10.2	↘
10:	10.2	←
<b>Series</b>	<b>91 ( 1x)</b>	
	<b>274 ( 3x)</b>	

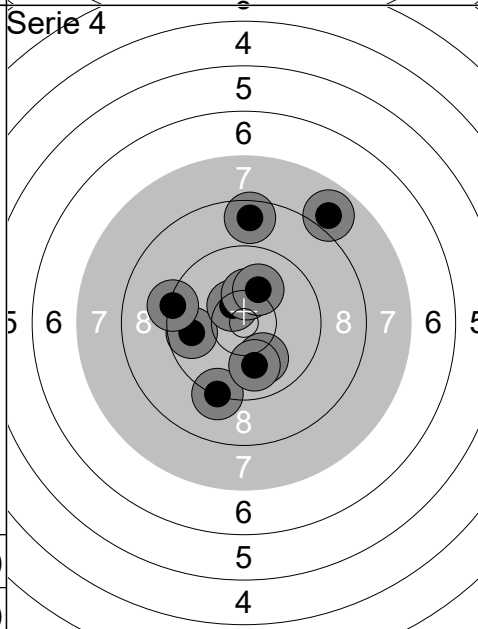

1:	9.3	↘
2:	9.8	←
3:	10.1	↘
4:	7.9	↗
5:	9.3	←
6:	8.6	↑
7:	10.0	↘
8:	10.5x	↖
9:	10.3	↑
10:	10.1	↗
<b>Series</b>	<b>92 ( 1x)</b>	
	<b>366 ( 4x)</b>	

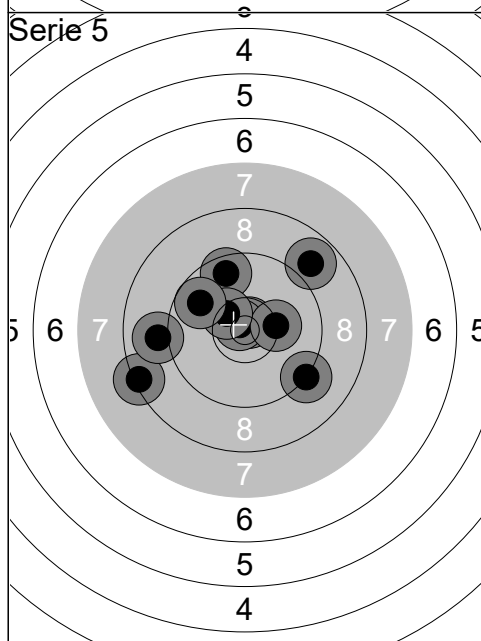

1:	9.2	↘
2:	10.8x	↗
3:	8.3	←
4:	8.9	↗
5:	9.0	←
6:	9.6	↑
7:	10.8x	↖
8:	10.3	→
9:	10.4x	↖
10:	9.8	↖
<b>Series</b>	<b>92 ( 3x)</b>	
	<b>458 ( 7x)</b>	

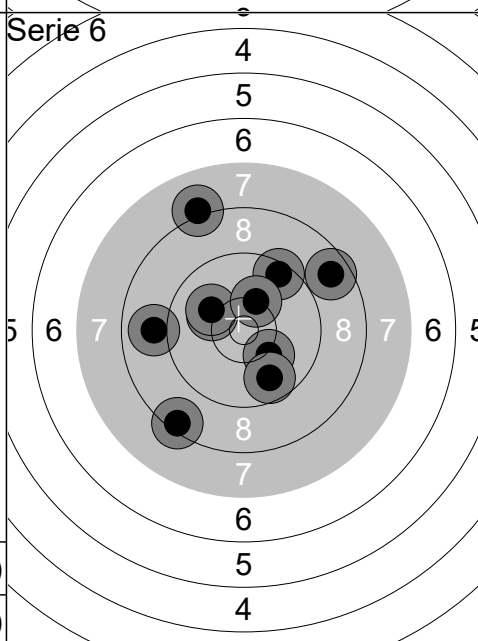

1:	10.2	←
2:	10.1	↖
3:	10.2	↘
4:	8.6	↗
5:	9.5	↗
6:	8.1	↑
7:	10.3	↗
8:	9.7	↘
9:	8.9	←
10:	8.4	↘
<b>Series</b>	<b>90 ( 0x)</b>	
	<b>548 ( 7x)</b>	

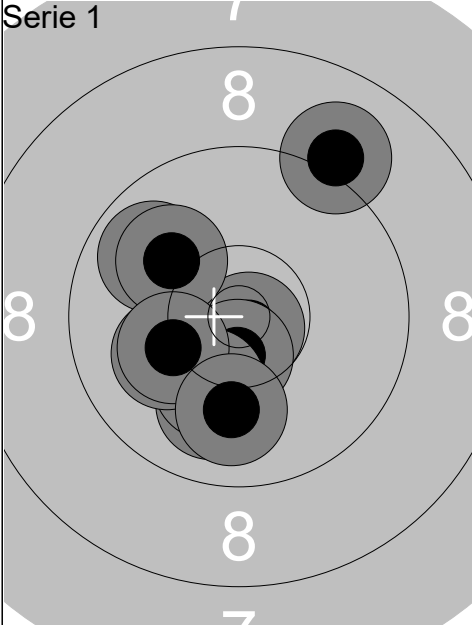
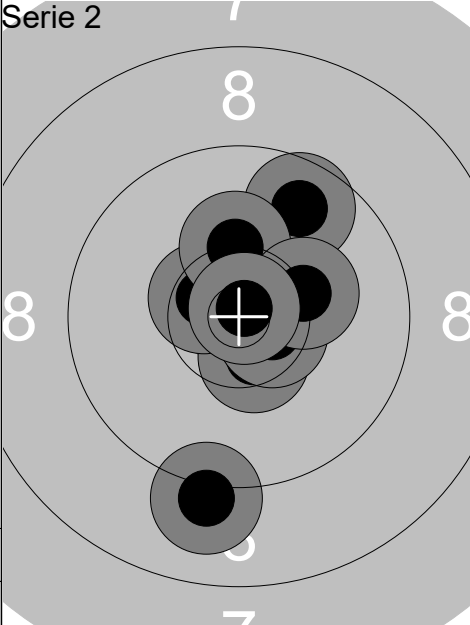
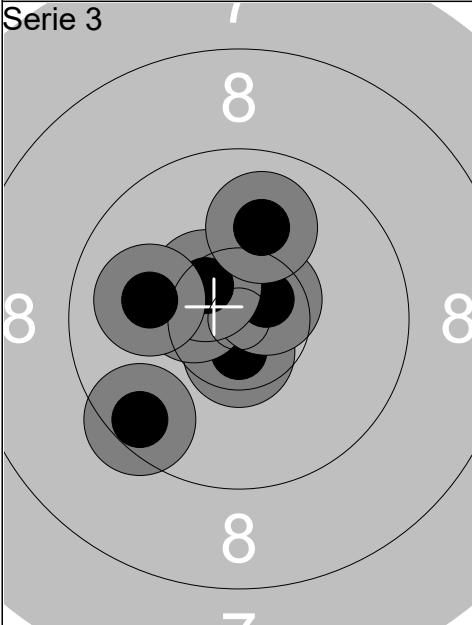
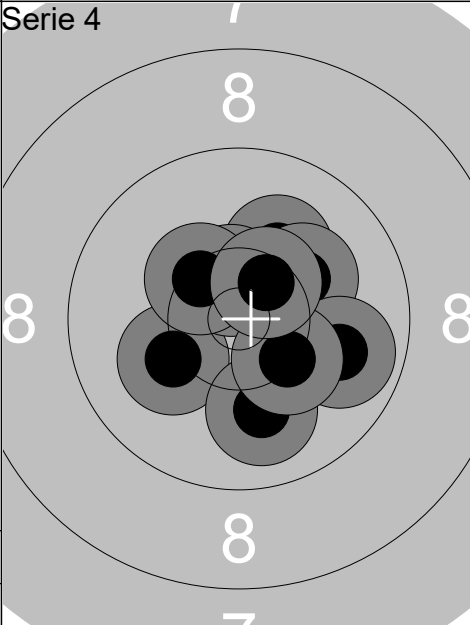
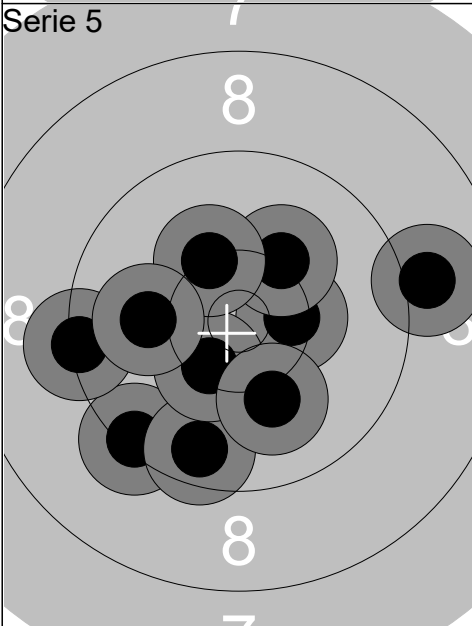
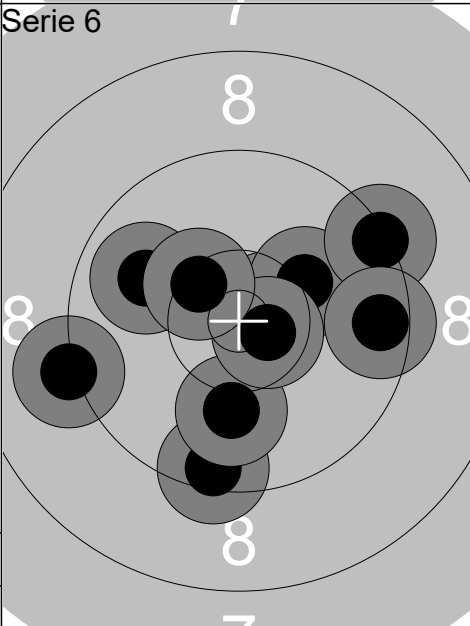
Relay	Lane	Marcus Errebo		
Day 2 Denmark Open Air	Maribo Skytteforening	Mp		
15.02.2020	Day 2 Denmark Open Air 2020	Denmark Open Air 2020		
Serie 1 	1: 9.1 ↗	Serie 2 	1: 10.4x ↗	
	2: 9.9 ↖		2: 9.7 ↗	
	3: 10.8x ↘		3: 10.8x ↖	
	4: 10.6x ↓		4: 10.5x ↓	
	5: 10.0 ↓		5: 10.5x ↖	
	6: 10.2 ↓		6: 10.2 ↑	
	7: 10.1 ↖		7: 10.6x →	
	8: 10.1 ↙		8: 9.1 ↓	
	9: 10.2 ↙		9: 10.2 →	
	10: 10.0 ↓		10: 10.8x ↗	
	Series 98 ( 2x)		Series 98 ( 6x)	
	98 ( 2x)		196 ( 8x)	
Serie 3 	1: 10.5x ↖	Serie 4 	1: 10.3 →	
	2: 10.6x ↓		2: 10.2 ↗	
	3: 10.6x ↑		3: 10.2 ↙	
	4: 10.6x ↑		4: 10.2 ↗	
	5: 9.5 ↙		5: 10.0 ↓	
	6: 10.5x ↖		6: 9.9 →	
	7: 10.6x ↗		7: 10.5x ↑	
	8: 10.5x ↖		8: 10.4x ↖	
	9: 10.0 ↙		9: 10.3 ↘	
	10: 10.0 ↑		10: 10.5x ↗	
	Series 99 ( 7x)		Series 99 ( 3x)	
	295 (15x)		394 (18x)	
Serie 5 	1: 10.4x →	Serie 6 	1: 9.4 ↓	
	2: 9.4 ↙		2: 10.6x →	
	3: 9.0 →		3: 10.2 ↗	
	4: 10.2 ↗		4: 9.3 ↗	
	5: 9.6 ↓		5: 9.9 ↖	
	6: 10.4x ↘		6: 10.0 ↓	
	7: 10.3 ↗		7: 9.2 ↙	
	8: 10.1 ↓		8: 10.6x →	
	9: 9.3 ↙		9: 10.4x ↖	
	10: 10.0 ↙		10: 9.5 →	
	Series 96 ( 2x)		Series 95 ( 3x)	
	490 (20x)		585 (23x)	

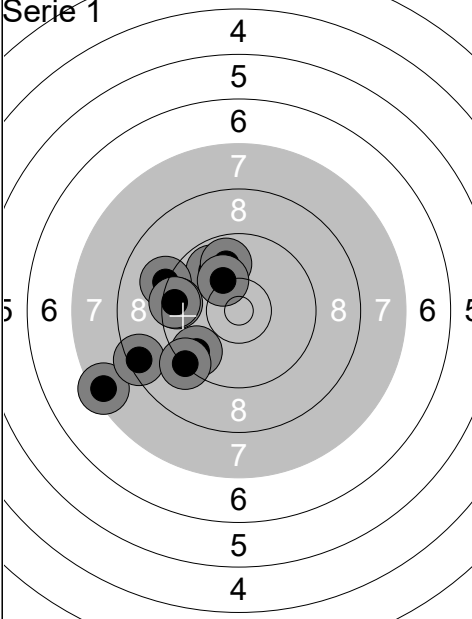
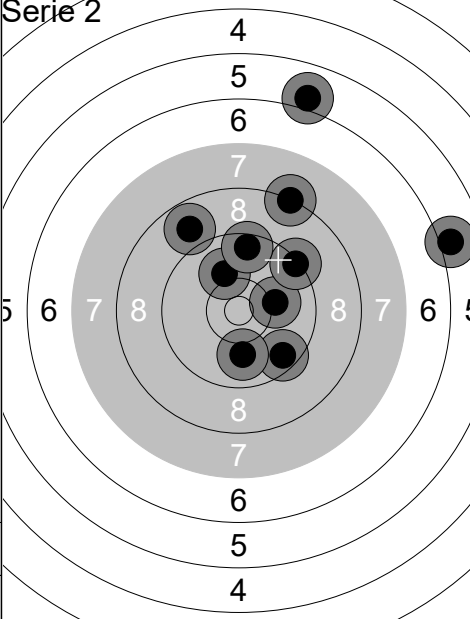
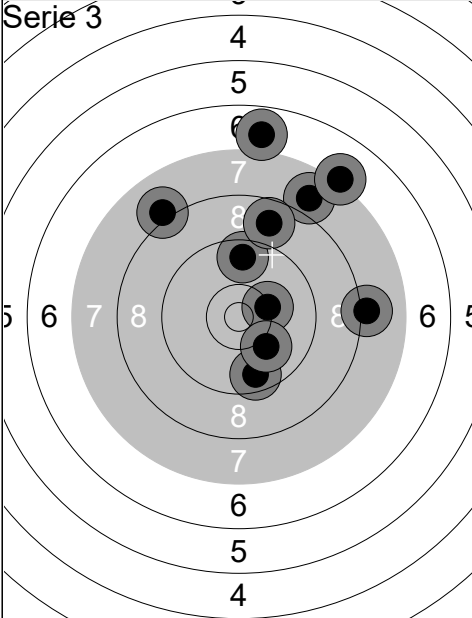
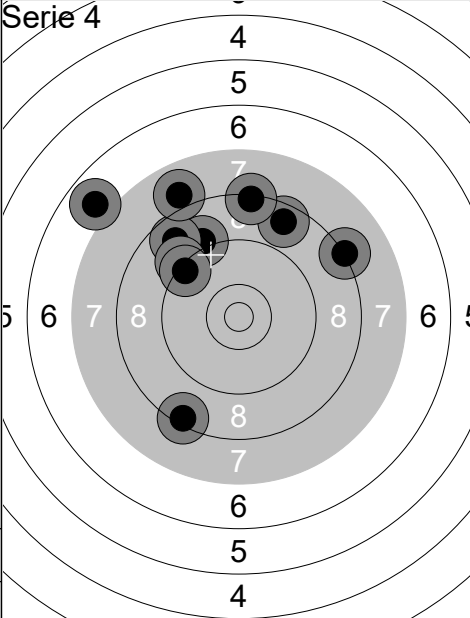
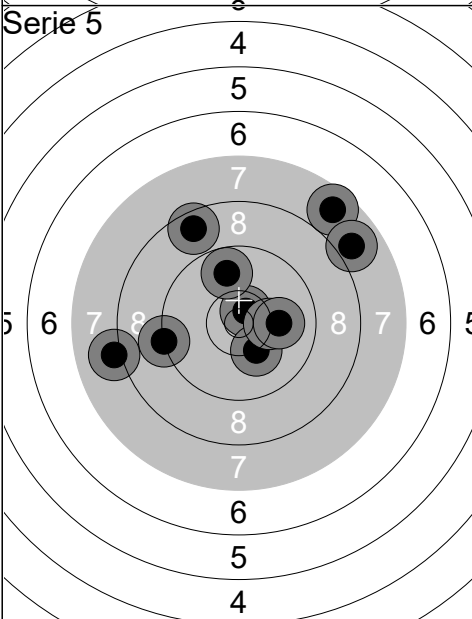
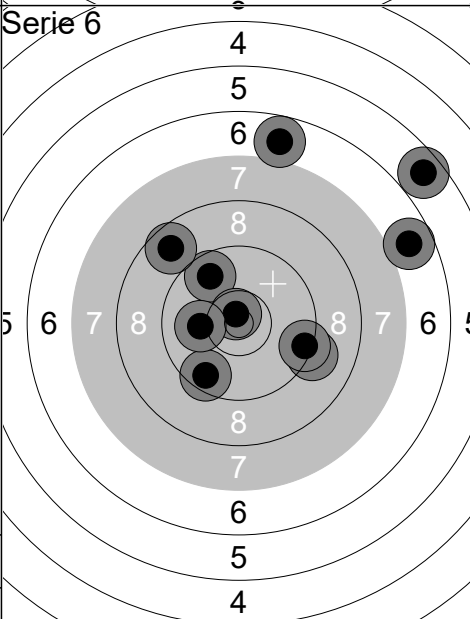

Relay	Lane	Max Reichle	
Day 2 Denmark Open Air	Vejle Skytteforening	Mp	
15.02.2020	Day 2 Denmark Open Air 2020	Denmark Open Air 2020	
Serie 1 	1: 9.6 ↙	Serie 2 	1: 10.1 →
	2: 9.9 ↗		2: 8.2 ↗
	3: 7.5 ↙		3: 6.0 ↗
4: 8.5 ↙	4: 10.1 ↗	4: 10.1 ↗	4: 10.1 ↗
5: 9.2 ↙	5: 8.8 ↗	5: 8.8 ↗	5: 8.8 ↗
6: 9.6 ↙	6: 9.5 ↘	6: 9.5 ↘	6: 9.5 ↘
7: 9.5 ↙	7: 9.3 ↗	7: 9.3 ↗	7: 9.3 ↗
8: 9.9 ↗	8: 10.0 ↓	8: 10.0 ↓	8: 10.0 ↓
9: 9.3 ↙	9: 9.5 ↗	9: 9.5 ↗	9: 9.5 ↗
10: 10.2 ↗	10: 6.0 →	10: 6.0 →	10: 6.0 →
Series 88 (0x)	Series 85 (0x)	Series 173 (0x)	
88 (0x)	173 (0x)		
Serie 3 	1: 9.6 ↗	Serie 4 	1: 9.1 ↗
	2: 8.1 ↗		2: 8.7 ↗
	3: 7.9 ↗		3: 9.2 ↗
4: 10.3 →	4: 8.4 ↓	4: 8.4 ↓	4: 8.4 ↓
5: 6.9 ↗	5: 8.2 ↗	5: 8.2 ↗	5: 8.2 ↗
6: 8.1 →	6: 6.9 ↗	6: 6.9 ↗	6: 6.9 ↗
7: 8.7 ↗	7: 9.4 ↗	7: 9.4 ↗	7: 9.4 ↗
8: 9.6 ↓	8: 7.9 ↗	8: 7.9 ↗	8: 7.9 ↗
9: 7.1 ↗	9: 8.6 ↗	9: 8.6 ↗	9: 8.6 ↗
10: 10.0 ↓	10: 8.3 ↗	10: 8.3 ↗	10: 8.3 ↗
Series 82 (0x)	Series 80 (0x)	Series 335 (0x)	
255 (0x)	335 (0x)		
Serie 5 	1: 10.6x ↗	Serie 6 	1: 5.6 ↗
	2: 7.7 ↗		2: 9.7 ↗
	3: 9.2 ↙		3: 9.2 →
4: 10.2 ↓	4: 9.6 ↓	4: 9.6 ↓	4: 9.6 ↓
5: 8.6 ↗	5: 6.8 ↗	5: 6.8 ↗	5: 6.8 ↗
6: 9.8 ↗	6: 8.7 ↗	6: 8.7 ↗	6: 8.7 ↗
7: 10.3 →	7: 10.7x ↗	7: 10.7x ↗	7: 10.7x ↗
8: 10.1 →	8: 6.8 →	8: 6.8 →	8: 6.8 →
9: 7.9 ↗	9: 10.1 ↙	9: 10.1 ↙	9: 10.1 ↙
10: 8.1 ↙	10: 9.4 →	10: 9.4 →	10: 9.4 →
Series 88 (1x)	Series 81 (1x)	Series 504 (2x)	
423 (1x)	504 (2x)		

Relay	Lane	Hans Petter Norland		
Day 2 Denmark Open Air	Lillestrøm PK	Mp		
15.02.2020	Day 2 Denmark Open Air 2020	Denmark Open Air 2020		
Serie 1 	1: 9.3 ↖	Serie 2 	1: 9.0 ↗	
	2: 8.7 ↑		2: 9.4 ↙	
	3: 10.4x ↗		3: 9.0 ↗	
	4: 7.5 →		4: 9.6 ←	
	5: 10.4x ↖		5: 8.4 ↗	
	6: 9.9 ←		6: 10.4 ↓	
	7: 10.3 ↓		7: 10.0 →	
	8: 8.8 ↗		8: 10.4x →	
	9: 8.8 ↖		9: 9.3 ↙	
	10: 9.5 ↖		10: 9.2 ↑	
	Series 88 ( 2x)		Series 92 ( 1x)	
	88 ( 2x)		180 ( 3x)	
Serie 3 	1: 10.1 ↑	Serie 4 	1: 10.1 ←	
	2: 9.9 ↓		2: 8.0 ↖	
	3: 9.8 ↑		3: 9.4 ←	
	4: 9.5 ↗		4: 8.6 ↑	
	5: 8.5 ↑		5: 9.8 →	
	6: 10.8x ↓		6: 10.3 ↗	
	7: 8.9 ↙		7: 9.3 ↖	
	8: 10.6x ↗		8: 10.2 ↑	
	9: 9.3 ↙		9: 10.8x ↙	
	10: 10.0 ←		10: 9.9 ↙	
	Series 92 ( 2x)		Series 92 ( 1x)	
	272 ( 5x)		364 ( 6x)	
Serie 5 	1: 8.1 ↗	Serie 6 	1: 9.3 ↑	
	2: 9.4 ↑		2: 9.2 ↖	
	3: 9.4 ↓		3: 8.7 ←	
	4: 10.4x ↖		4: 9.0 ↓	
	5: 7.4 ↗		5: 10.0 ↗	
	6: 9.9 ↑		6: 9.4 ↙	
	7: 9.1 ↖		7: 8.5 ↙	
	8: 8.9 ←		8: 10.1 ↓	
	9: 9.1 ↖		9: 8.8 ↓	
	10: 10.2 ↑		10: 9.7 ↗	
	Series 88 ( 1x)		Series 89 ( 0x)	
	452 ( 7x)		541 ( 7x)	

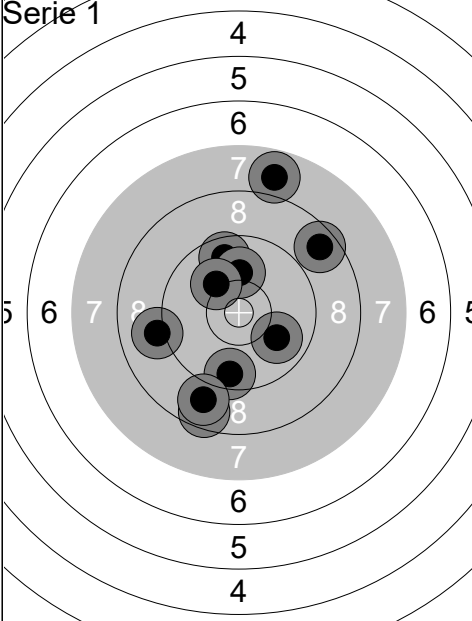
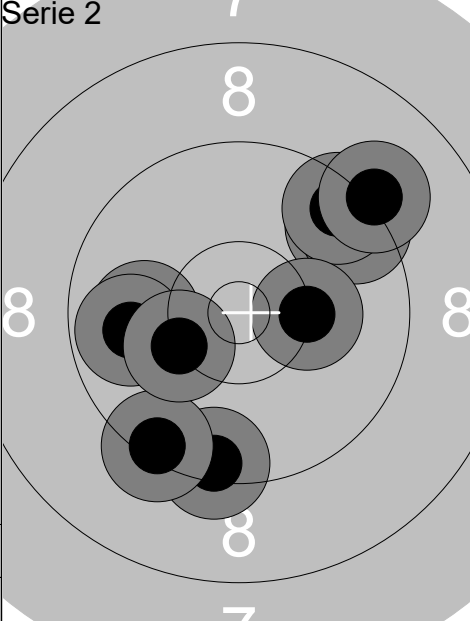
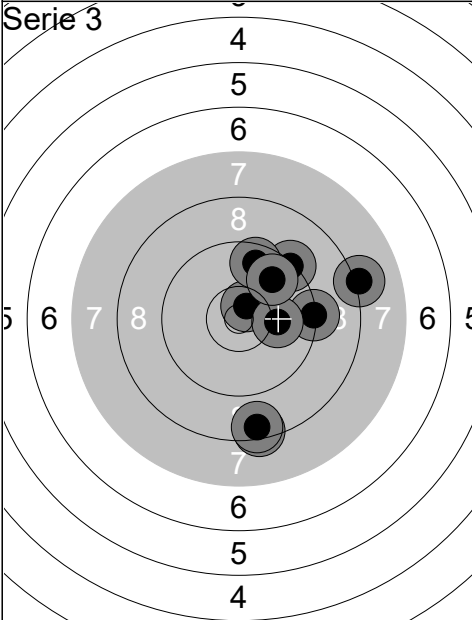
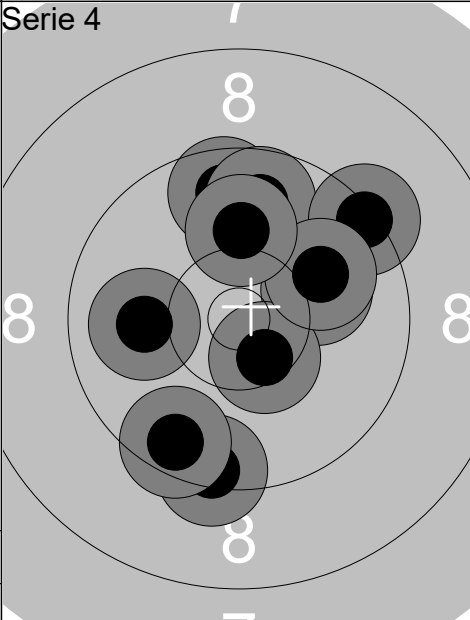
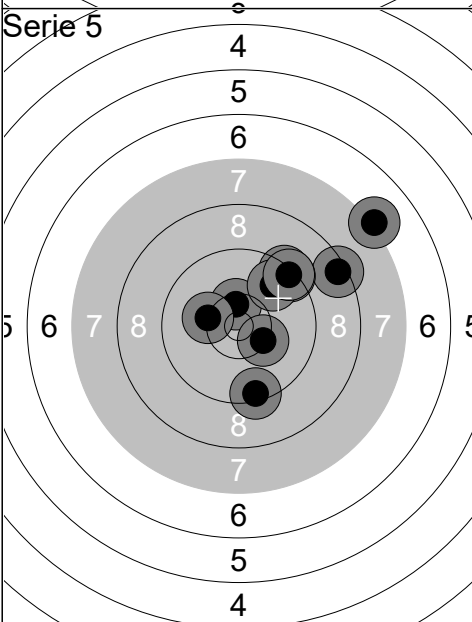
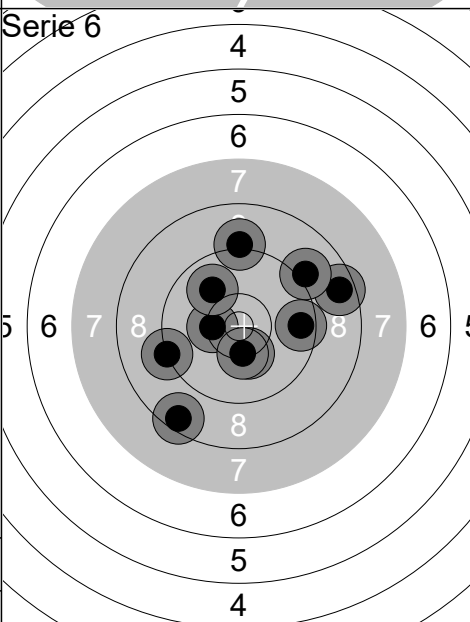
Relay <b>3</b>	Lane <b>11</b>	<b>Oliver Høyer</b>			
Day 2 Denmark Open Air		Rødovre Skytteforening		Mp	
15.02.2020		Day 2 Denmark Open Air 2020	Denmark Open Air 2020		
Serie 1			1: 9.1 ← 2: 8.6 ↗ 3: 9.6 ↓ 4: 8.6 ↓ 5: 8.9 ↓ 6: 7.8 ↑ 7: 9.7 ↑ 8: 10.1 ↑ 9: 10.1 ↖ 10: 9.9 ↘ Series 87 (0x) 87 (0x)	Serie 2 	1: 9.6 ↗ 2: 10.0 ← 3: 9.8 ← 4: 9.5 ↗ 5: 9.4 ↓ 6: 9.4 ↓ 7: 10.3 ← 8: 9.5 ↗ 9: 9.2 ↗ 10: 10.3 → Series 93 (0x) 180 (0x)
Serie 3			1: 10.3 ↗ 2: 8.4 ↓ 3: 9.3 → 4: 8.1 → 5: 10.6x ↗ 6: 10.1 → 7: 9.3 ↗ 8: 8.5 ↓ 9: 9.6 ↑ 10: 9.8 ↗ Series 90 (1x) 270 (1x)	Serie 4 	1: 10.0 ← 2: 9.7 ↑ 3: 10.1 → 4: 9.4 ↓ 5: 9.6 ↓ 6: 10.5x ↘ 7: 9.7 ↑ 8: 9.3 ↗ 9: 10.0 ↗ 10: 10.1 ↑ Series 95 (1x) 365 (2x)
Serie 5			1: 8.4 ↗ 2: 9.4 ↗ 3: 7.1 ↗ 4: 9.4 ↗ 5: 10.5x ↑ 6: 9.7 ↗ 7: 9.3 ↗ 8: 10.3 ↘ 9: 9.4 ↓ 10: 10.2 ← Series 90 (1x) 455 (3x)	Serie 6 	1: 9.6 → 2: 8.6 → 3: 8.5 ↓ 4: 9.2 ← 5: 10.3 ↓ 6: 9.1 ↗ 7: 9.1 ↑ 8: 10.4 ← 9: 10.0 ↖ 10: 10.3 ↓ Series 92 (0x) 547 (3x)

Relay	Lane	Anders Kaa Bach			
3	12	Aarhus Pistolskytteforening		Mp	
Day 2 Denmark Open Air		Day 2 Denmark Open Air 2020		Denmark Open Air 2020	
15.02.2020					
Serie 1	4	1: 10.6x ↑	Serie 2	4	1: 9.3 ↓
	5	2: 9.3 ↘		5	2: 8.2 →
	6	3: 9.4 ↓		6	3: 8.7 →
	7	4: 9.6 ↗		7	4: 9.8 ↓
	8	5: 6.9 →		8	5: 9.0 ←
	8	6: 9.4 →		8	6: 9.6 ↗
	7	7: 8.8 ↓		7	7: 10.1 ↗
	6	8: 9.2 ↖		6	8: 9.3 ↖
	5	9: 9.6 ↗		5	9: 8.7 ↓
	4	10: 9.6 ↑		4	10: 9.8 ←
	Series 87 ( 1x)		Series 88 ( 0x)		
	87 ( 1x)		175 ( 1x)		
Serie 3	4	1: 10.2 ↓	Serie 4	4	1: 10.5x →
	5	2: 10.4x ↓		5	2: 9.5 ↗
	6	3: 9.1 →		6	3: 10.2 ←
	7	4: 8.5 ↑		7	4: 10.1 ↓
	8	5: 9.7 ←		8	5: 9.8 ↗
	8	6: 8.9 ←		8	6: 7.7 ↗
	7	7: 9.6 ↓		7	7: 9.9 ↓
	6	8: 9.2 ←		6	8: 10.1 ↑
	5	9: 8.6 →		5	9: 8.4 →
	4	10: 8.7 →		4	10: 9.4 ↗
	Series 88 ( 1x)		Series 91 ( 1x)		
	263 ( 2x)		354 ( 3x)		
Serie 5	4	1: 8.6 ↗	Serie 6	4	1: 9.9 ↗
	5	2: 10.1 ↓		5	2: 6.7 ↗
	6	3: 8.3 ↓		6	3: 8.9 ←
	7	4: 8.6 ↓		7	4: 7.9 ↑
	8	5: 9.6 ↓		8	5: 9.4 →
	8	6: 9.8 ↓		8	6: 10.5x ↗
	7	7: 10.5x ↗		7	7: 10.0 ↖
	6	8: 8.8 ↑		6	8: 9.3 →
	5	9: 9.0 ↗		5	9: 9.0 ←
	4	10: 8.8 ↑		4	10: 9.3 ↓
	Series 87 ( 1x)		Series 86 ( 1x)		
	441 ( 4x)		527 ( 5x)		

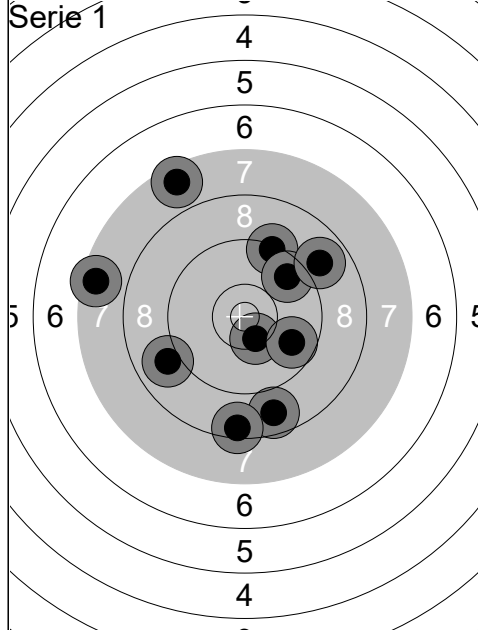

1:	7.6	↖
2:	8.7	↘
3:	9.3	↗
4:	7.5	↙
5:	9.6	↗
6:	9.0	↙
7:	8.5	↘
8:	10.4x	↘
9:	8.9	↗
10:	9.8	↘
<b>Series</b>		<b>84 ( 1x)</b>
		<b>84 ( 1x)</b>

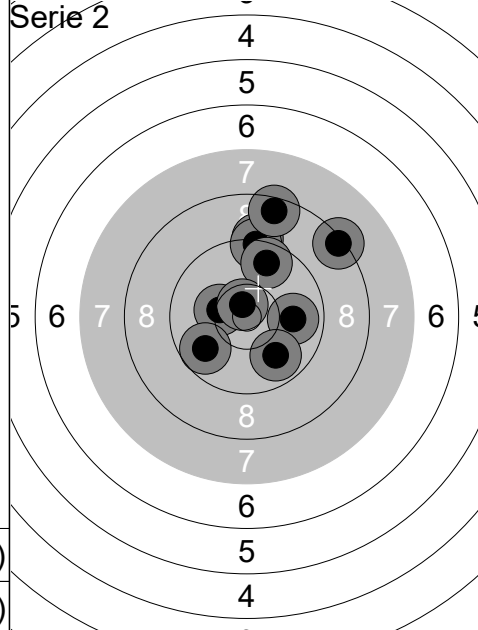

1:	9.9	→
2:	9.2	↑
3:	8.3	↗
4:	9.3	↑
5:	9.9	↘
6:	10.3	↙
7:	9.7	↗
8:	8.5	↑
9:	10.7x	↖
10:	9.8	↙
<b>Series</b>		<b>90 ( 1x)</b>
		<b>174 ( 2x)</b>

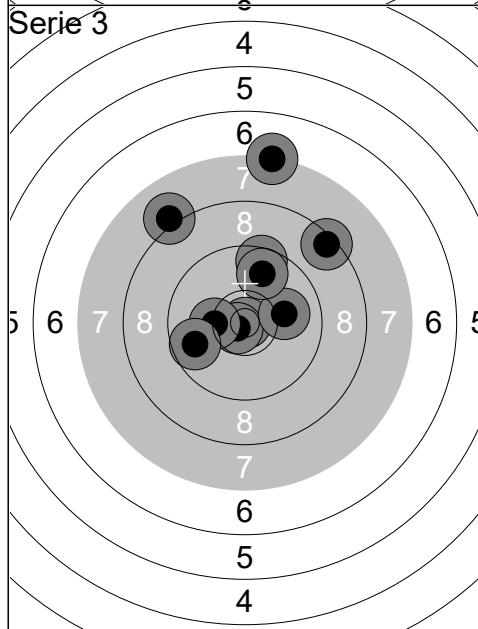

1:	10.9x	→
2:	9.5	↑
3:	8.1	↖
4:	10.7x	↙
5:	10.0	→
6:	9.8	↑
7:	10.3	↙
8:	8.4	↗
9:	9.7	↙
10:	7.2	↑
<b>Series</b>		<b>90 ( 2x)</b>
		<b>264 ( 4x)</b>

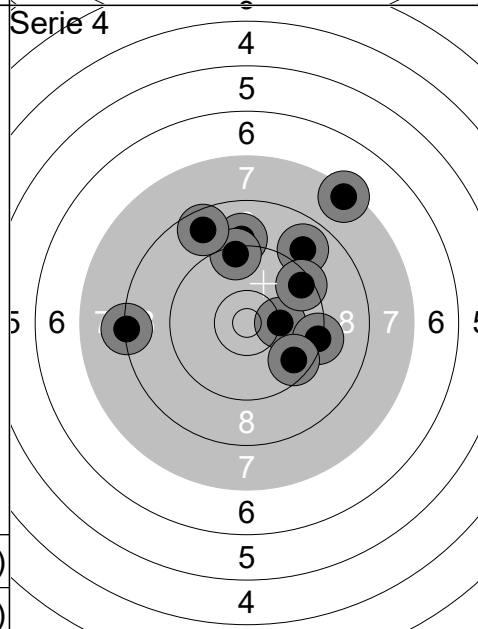

1:	9.1	↑
2:	9.4	↑
3:	10.2	→
4:	7.4	↗
5:	8.9	↗
6:	8.3	↙
7:	9.3	→
8:	9.6	↘
9:	8.7	↗
10:	9.5	↗
<b>Series</b>		<b>86 ( 0x)</b>
		<b>350 ( 4x)</b>

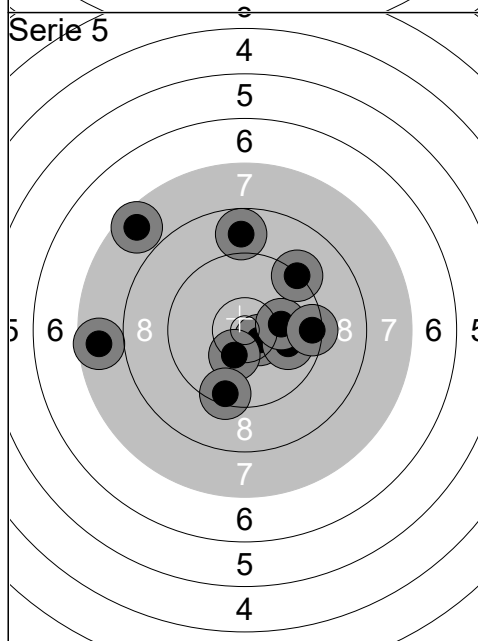

1:	10.5x	↘
2:	9.9	→
3:	10.3	↘
4:	10.1	→
5:	7.6	↖
6:	9.3	↗
7:	8.8	↑
8:	7.7	↙
9:	9.5	↘
10:	9.4	→
<b>Series</b>		<b>88 ( 1x)</b>
		<b>438 ( 5x)</b>

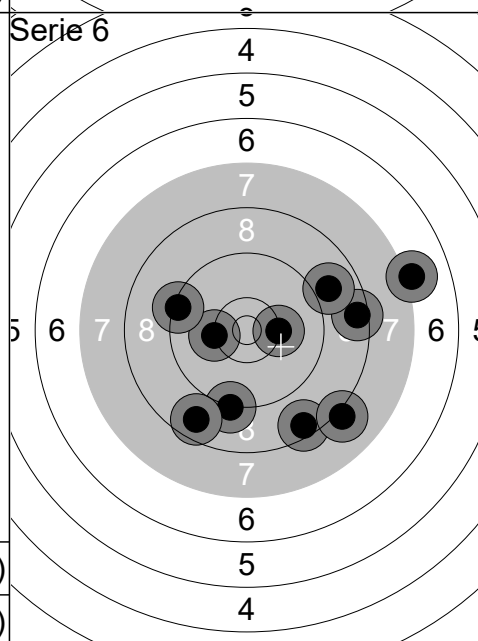

1:	10.2	↙
2:	8.5	→
3:	8.9	↗
4:	9.2	↘
5:	8.5	↘
6:	8.7	↘
7:	10.2	→
8:	9.3	↙
9:	8.1	↘
10:	7.1	→
<b>Series</b>		<b>85 ( 0x)</b>
		<b>523 ( 5x)</b>

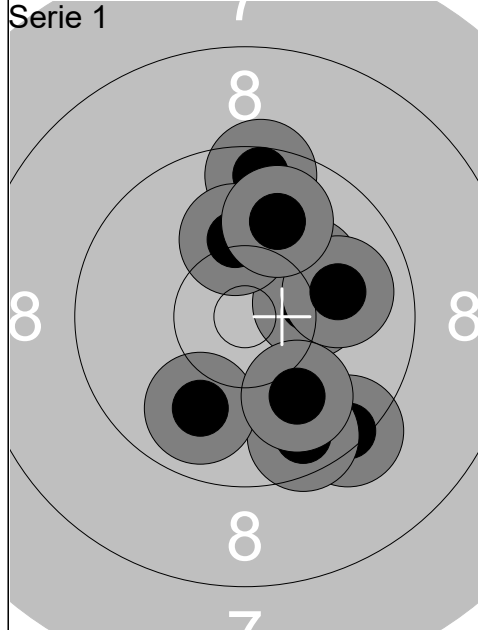

1:	9.4	↘
2:	10.2	↗
3:	10.3	→
4:	10.0	→
5:	9.5	↑
6:	10.2	↑
7:	9.6	↘
8:	9.9	↑
9:	9.9	↘
10:	10.0	↘
<b>Series</b>	<b>95 ( 0x)</b>	
	<b>95 ( 0x)</b>	

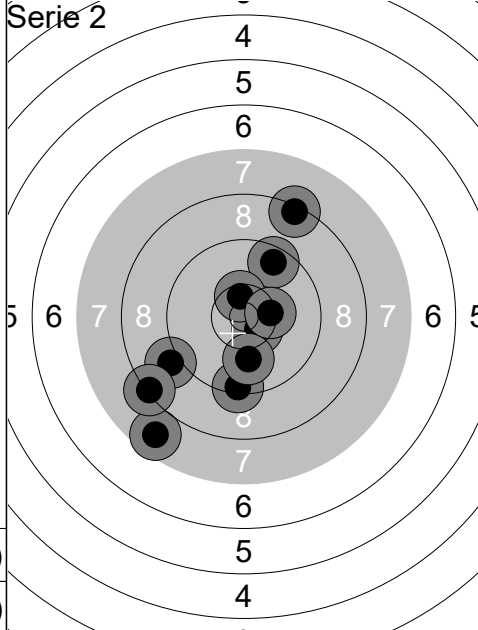

1:	9.6	↗
2:	7.7	↘
3:	10.5x	↘
4:	10.5x	↑
5:	9.4	↘
6:	10.0	↘
7:	10.3	→
8:	8.4	↗
9:	9.0	↙
10:	8.3	↙
<b>Series</b>	<b>90 ( 2x)</b>	
	<b>185 ( 2x)</b>	

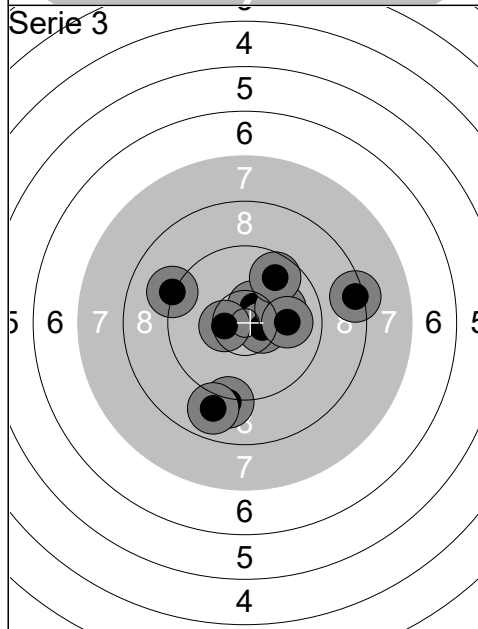

1:	9.2	↙
2:	10.5x	↗
3:	10.5x	→
4:	8.4	→
5:	10.5x	↙
6:	9.1	↘
7:	10.1	→
8:	8.9	↘
9:	9.7	↗
10:	10.0	→
<b>Series</b>	<b>93 ( 3x)</b>	
	<b>278 ( 5x)</b>	

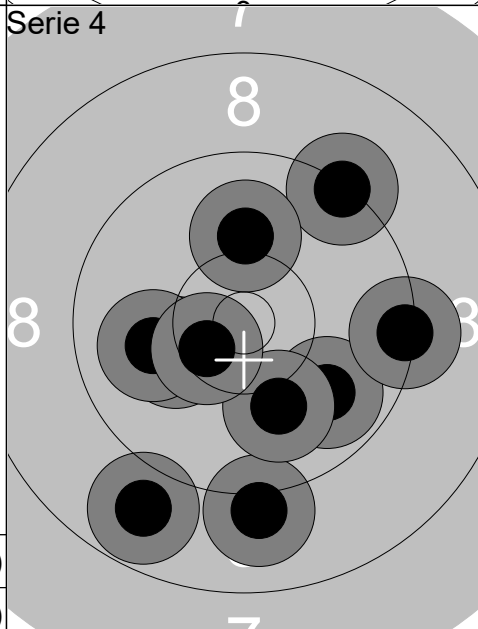

1:	9.1	↘
2:	9.8	↘
3:	10.2	↙
4:	10.0	↘
5:	9.3	↗
6:	8.8	↘
7:	10.1	↑
8:	10.0	↙
9:	9.3	→
10:	10.5x	↙
<b>Series</b>	<b>94 ( 1x)</b>	
	<b>372 ( 6x)</b>	

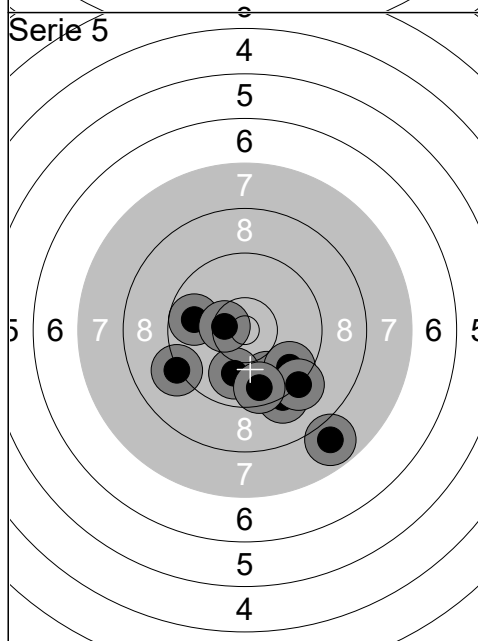

1:	9.8	↘
2:	9.7	↘
3:	9.2	↘
4:	7.9	↘
5:	10.0	↘
6:	9.2	↙
7:	9.2	↘
8:	9.8	↙
9:	9.6	↘
10:	10.5x	↙
<b>Series</b>	<b>90 ( 1x)</b>	
	<b>462 ( 7x)</b>	

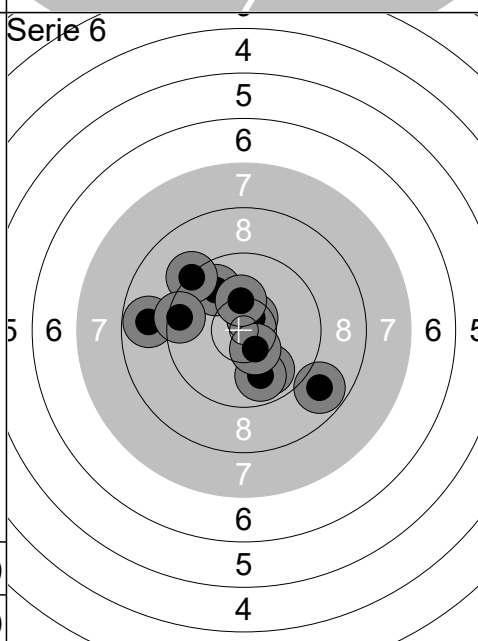

1:	8.8	↘
2:	9.9	↘
3:	9.9	↘
4:	10.6x	↗
5:	9.9	↗
6:	8.8	↙
7:	9.3	↗
8:	9.5	↙
9:	10.5x	↘
10:	10.3	↑
<b>Series</b>	<b>91 ( 2x)</b>	
	<b>553 ( 9x)</b>	