

Relay	Lane	Maria Andersen		
1 Air Qualification	DEN	W	Rifle	
17.02.2023	DENMARK OPEN AIR 2023 DAY1	Danmark Open Air 2023		
Series 1	1: 10.1 ↖ 2: 10.2x ↗ 3: 9.7 ↖ 4: 10.0 → 5: 9.6 ↗ 6: 10.4x ↗ 7: 9.6 ↓ 8: 10.0 ↓ 9: 10.6x ↓ 10: 9.4 → Series 99.6 99.6	Series 2	1: 10.4x → 2: 9.7 ↗ 3: 10.4x ↘ 4: 9.7 ↖ 5: 10.7x → 6: 10.1 → 7: 10.1 ↗ 8: 9.9 ↓ 9: 10.4x ← 10: 10.0 ↗ Series 101.4 201.0	
Series 3	1: 10.2x ↗ 2: 10.2x ↓ 3: 10.0 ↑ 4: 10.5x ↘ 5: 10.2x ↗ 6: 10.1 → 7: 10.8x ← 8: 10.4x ↘ 9: 10.0 ↘ 10: 9.4 → Series 101.8 302.8	Series 4	1: 10.2x → 2: 10.1 ↑ 3: 10.6x → 4: 10.2x ↑ 5: 9.7 ← 6: 9.7 → 7: 10.3x → 8: 10.6x ↘ 9: 10.3x ↖ 10: 10.8x ↗ Series 102.5 405.3	
Series 5	1: 9.4 ← 2: 10.4x ↖ 3: 8.8 ← 4: 10.1 ↗ 5: 9.6 → 6: 9.9 ↗ 7: 10.3x ↓ 8: 10.3x ↓ 9: 10.1 → 10: 10.3x → Series 99.2 504.5	Series 6	1: 10.4x → 2: 10.6x ↓ 3: 10.2x ↓ 4: 9.9 → 5: 10.1 ↗ 6: 10.3x ↖ 7: 10.9x ↑ 8: 10.5x → 9: 10.4x ↘ 10: 10.7x ← Series 104.0 608.5	

Relay 1	Lane 12	Simone Berg		
-------------------	-------------------	--------------------	--	--

1 Air Qualification	DEN	W	Rifle
---------------------	-----	---	-------

17.02.2023	DENMARK OPEN AIR 2023 DAY1	Danmark Open Air 2023	
------------	----------------------------	-----------------------	--

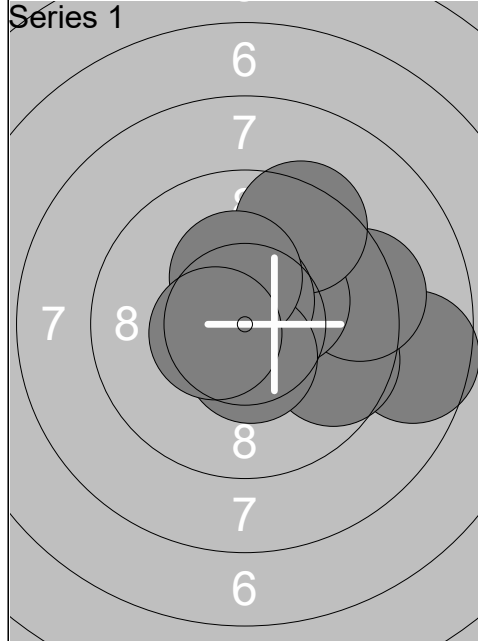

1: 10.7x	➤
2: 8.6	➤
3: 9.7	➤
4: 9.3	➤
5: 10.3x	➤
6: 9.4	↗
7: 10.6x	↑
8: 10.5x	↓
9: 10.3x	↑
10: 10.5x	↙
Series	99.9
	99.9

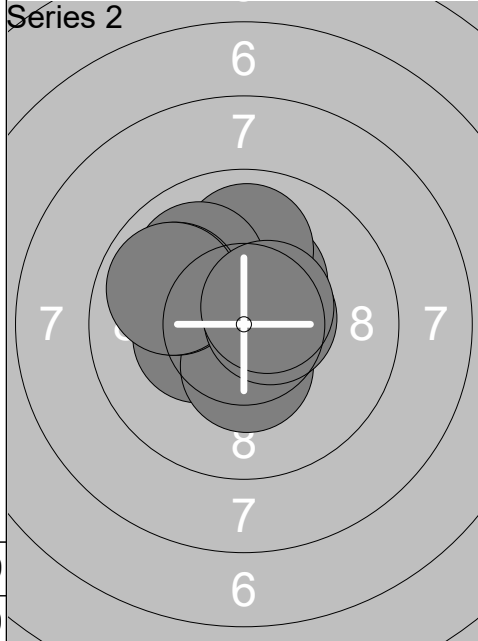

1: 10.3x	↗
2: 10.5x	↖
3: 10.3x	↙
4: 9.9	↑
5: 10.4x	↓
6: 10.0	↗
7: 9.9	↖
8: 9.8	↖
9: 10.6x	➤
10: 10.5x	↗
Series	102.2
	202.1

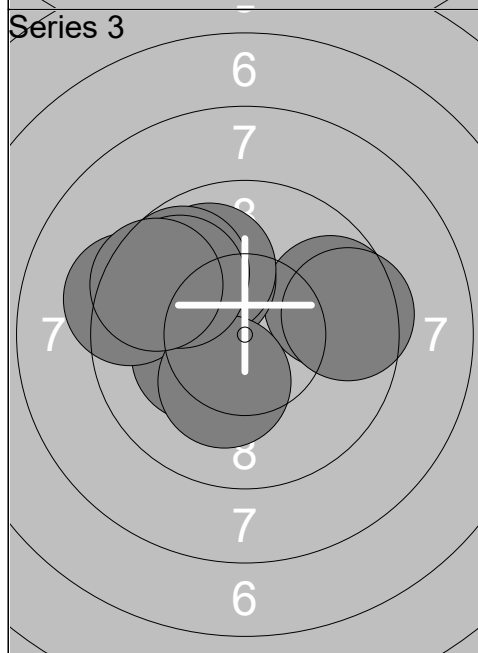

1: 10.2x	↙
2: 9.3	↖
3: 9.7	➤
4: 10.0	↗
5: 9.9	↗
6: 10.2x	↓
7: 9.7	↗
8: 9.8	↖
9: 9.5	➤
10: 9.6	↖
Series	97.9
	300.0

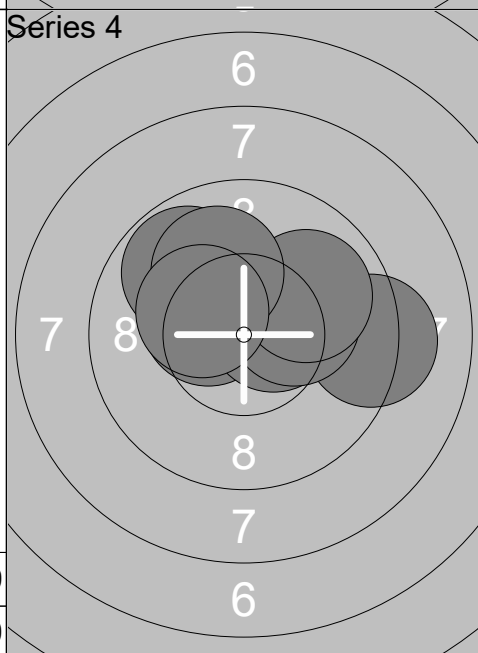

1: 10.4x	↖
2: 10.5x	➤
3: 10.0	↗
4: 10.0	➤
5: 9.2	➤
6: 9.8	↗
7: 10.2x	➤
8: 9.9	↗
9: 10.0	↑
10: 10.3x	↖
Series	100.3
	400.3

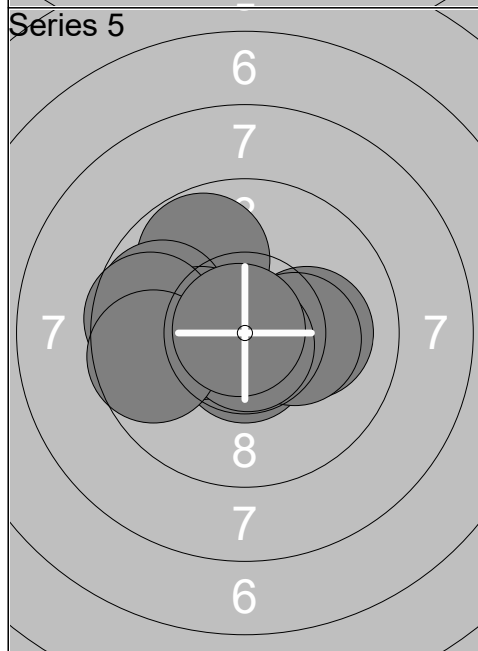

1: 9.8	↗
2: 10.6x	↓
3: 10.1	➤
4: 9.7	↖
5: 10.2x	➤
6: 10.3x	↙
7: 10.8x	↓
8: 9.6	↖
9: 9.6	↖
10: 10.9x	↖
Series	101.6
	501.9

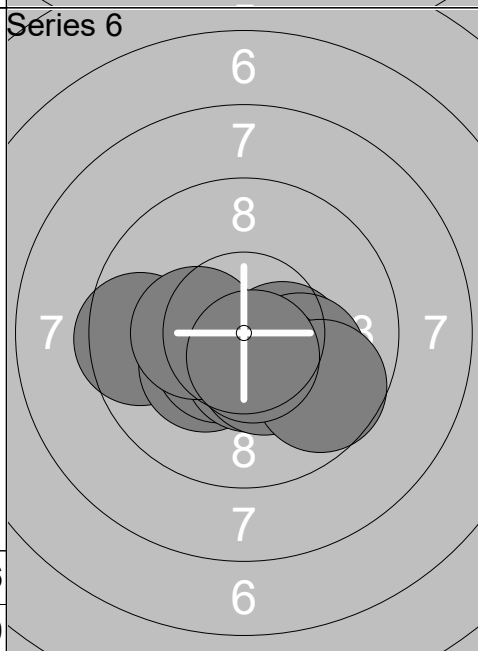

1: 10.4x	➤
2: 9.5	↖
3: 10.2x	↙
4: 10.5x	↙
5: 10.1	➤
6: 10.5x	↓
7: 10.3x	↙
8: 10.4x	↓
9: 9.7	↘
10: 10.6x	↓
Series	102.2
	604.1

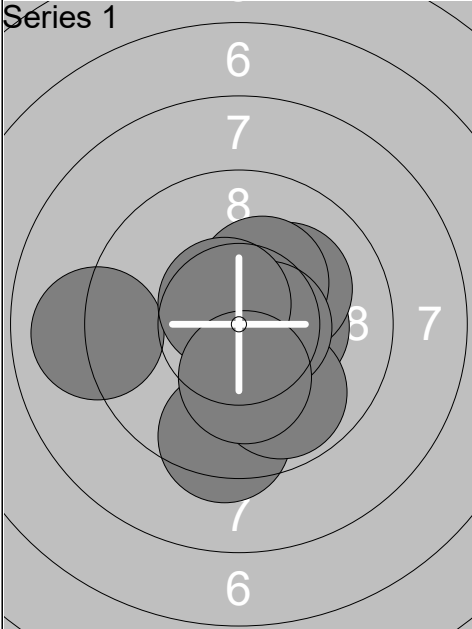
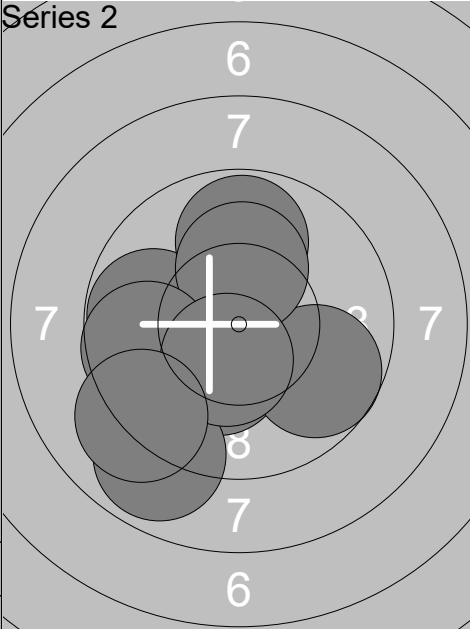
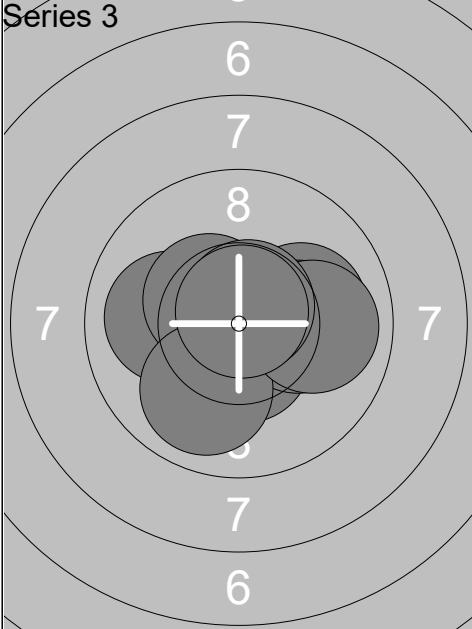
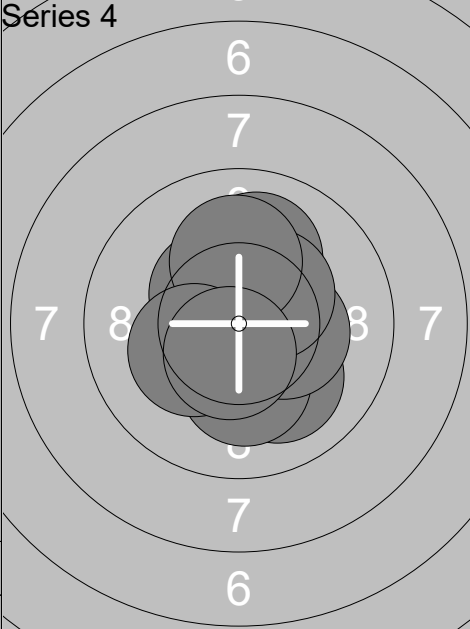
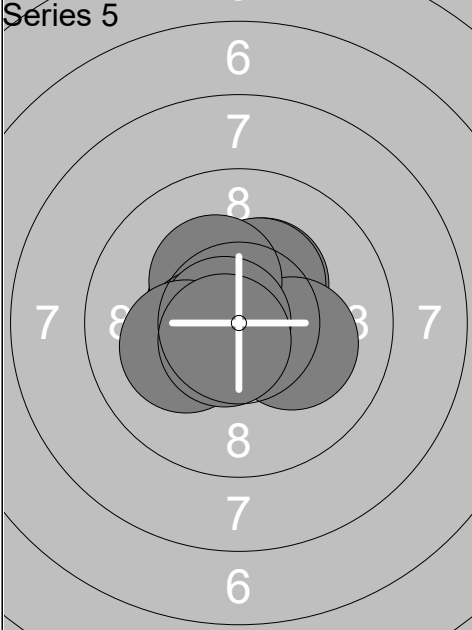
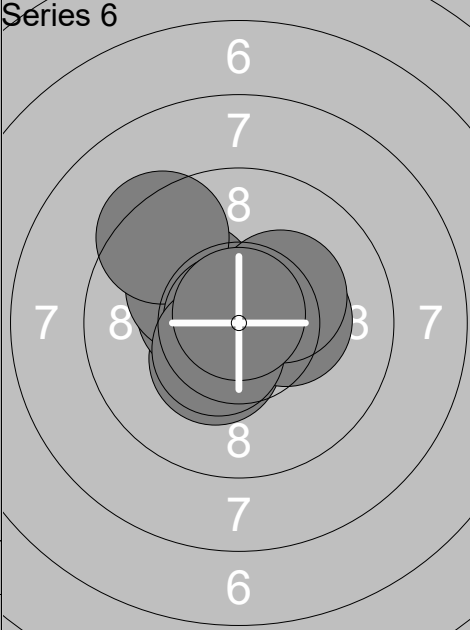
Relay	Lane	Katrine Christensen			
1	13	DEN		W	Rifle
17.02.2023		DENMARK OPEN AIR 2023 DAY1		Danmark Open Air 2023	
Series 1		1: 9.4 ↓	Series 2		1: 10.3x ↓
		2: 10.3x →			2: 8.9 ↓
		3: 10.2x ↓			3: 9.7 →
		4: 9.8 ↓			4: 10.4x ←
		5: 10.1 ↗			5: 9.8 ←
		6: 10.3x ↗			6: 9.8 ↑
		7: 10.6x →			7: 10.2x ↑
		8: 9.0 ←			8: 9.7 ←
		9: 10.6x ↖			9: 10.4x ↓
		10: 10.2x ↓			10: 9.1 ↓
		Series 100.5			Series 98.3
		100.5			198.8
Series 3		1: 10.0 ←	Series 4		1: 10.0 ↓
		2: 10.5x ↓			2: 10.1 ↓
		3: 10.1 →			3: 10.5x ←
		4: 10.5x ↖			4: 10.3x →
		5: 10.1 →			5: 10.0 ↑
		6: 10.4x ↖			6: 10.4x ↖
		7: 9.9 ↓			7: 10.4x ↗
		8: 9.9 →			8: 10.1 ↑
		9: 10.6x ↗			9: 10.2x ←
		10: 10.7x ↗			10: 10.5x ↓
		Series 102.7			Series 102.5
		301.5			404.0
Series 5		1: 10.5x ↖	Series 6		1: 10.3x ↓
		2: 10.3x ↗			2: 10.4x ←
		3: 10.8x →			3: 10.1 ↖
		4: 10.3x ↗			4: 10.9x ↓
		5: 10.2x →			5: 10.3x →
		6: 10.3x ↖			6: 10.3x ↗
		7: 10.4x ←			7: 9.4 ↖
		8: 10.7x ←			8: 10.8x ←
		9: 10.1 ←			9: 10.5x ↓
		10: 10.6x ↓			10: 10.8x ↑
		Series 104.2			Series 103.8
		508.2			612.0

Relay 1	Lane 14	Amanda Göranson					
1 Air Qualification		SWE		W Rifle			
17.02.2023		DENMARK OPEN AIR 2023 DAY1		Danmark Open Air 2023			
DNF							
Series 1 		1: 8.9 → 2: 9.7 ↑ 3: 9.8 ↑ 4: 10.5x ← 5: 10.2x ← 6: 9.9 ↘ 7: 10.3x ← 8: 10.2x ← 9: 10.3x → 10: 9.8 ↑ Series 99.6 99.6		Series 2 		1: 9.9 → 2: 10.2x → 3: 9.9 → 4: 10.5x ↗ 5: 10.3x ↓ 6: 10.2x ↓ 7: 10.5x ↘ 8: 9.9 ↑ 9: 9.4 → 10: 9.8 → Series 100.6 200.2	
Series 3 		1: 10.7x ↖ 2: 10.2x ← 3: 10.7x ↘ 4: 10.4x → 5: 10.4x → 6: 10.6x ↘ 7: 10.7x ↓ 8: 10.4x ↑ 9: 10.8x ↓ 10: 10.1 ↑ Series 105.0 305.2		Series 4 		1: 10.4x ↘ 2: 10.7x → 3: 10.6x → 4: 10.6x → 5: 9.6 → 6: 9.7 ↑ 7: 10.1 ↗ 8: 10.0 ← 9: 10.2x → 10: 10.2x ↑ Series 102.1 407.3	
Series 5 		1: 9.9 → 2: 10.0 → 3: 10.3x → 4: 9.3 ↓ 5: 10.1 ↑ 6: 10.4x → 7: 9.6 → 8: 10.2x ↗ 9: 10.5x ↓ 10: 10.0 → Series 100.3 507.6		Series 6 		1: 10.3x → 2: 9.7 → 3: 10.0 → 4: 9.8 → 5: 9.8 ↓ Series 49.6 557.2	

Relay	Lane	Hannah Göransson		
1	15	SWE	W	Rifle
17.02.2023	DENMARK OPEN AIR 2023 DAY1	Danmark Open Air 2023		
Series 1 	1: 10.8x ↘	Series 2 	1: 10.5x ↖	
	2: 10.8x ↖		2: 10.5x ↑	
	3: 10.8x ←		3: 10.5x ↗	
4: 10.6x ↓	4: 10.6x ↗	4: 10.4x →	4: 10.6x ↗	
5: 10.6x ←	5: 10.7x ↗	5: 10.7x →	5: 10.7x →	
6: 10.7x ↗	6: 10.7x ↗	6: 10.7x →	6: 10.7x →	
7: 9.9 ←	7: 9.9 ←	7: 10.0 →	7: 10.0 →	
8: 9.7 ↖	8: 9.7 ↖	8: 10.7x →	8: 10.7x →	
9: 10.0 ↗	9: 10.0 ↗	9: 10.5x ←	9: 10.5x ←	
10: 10.6x →	10: 10.6x →	10: 10.7x ↘	10: 10.7x ↘	
Series	104.5	Series	105.1	
	104.5		209.6	
Series 3 	1: 10.3x ↖	Series 4 	1: 10.5x →	
	2: 10.7x ↘		2: 10.8x ←	
	3: 10.6x ←		3: 10.1 ↓	
4: 10.5x ↑	4: 10.8x ↗	4: 10.5x ↗	4: 10.8x ↗	
5: 10.4x ↘	5: 10.4x ↘	5: 10.5x ↗	5: 10.5x ↗	
6: 10.2x →	6: 10.2x →	6: 10.5x ↘	6: 10.5x ↘	
7: 10.0 →	7: 10.0 →	7: 10.7x ↘	7: 10.7x ↘	
8: 10.1 ↓	8: 10.1 ↓	8: 10.7x ↖	8: 10.7x ↖	
9: 10.7x ↖	9: 10.7x ↖	9: 10.3x ↑	9: 10.3x ↑	
10: 10.5x ↖	10: 10.5x ↖	10: 10.7x ↗	10: 10.7x ↗	
Series	104.0	Series	105.6	
	313.6		419.2	
Series 5 	1: 10.1 ←	Series 6 	1: 10.2x ↘	
	2: 10.5x ↖		2: 10.4x ↗	
	3: 10.5x ←		3: 10.0 →	
4: 10.5x ↘	4: 10.5x ↘	4: 10.7x ↖	4: 10.7x ↖	
5: 10.6x ↑	5: 10.6x ↑	5: 10.7x ↗	5: 10.7x ↗	
6: 10.6x ↘	6: 10.6x ↘	6: 10.8x ↗	6: 10.8x ↗	
7: 10.2x ↗	7: 10.2x ↗	7: 10.7x →	7: 10.7x →	
8: 10.5x →	8: 10.5x →	8: 10.5x ↓	8: 10.5x ↓	
9: 9.9 →	9: 9.9 →	9: 10.2x ←	9: 10.2x ←	
10: 10.5x ←	10: 10.5x ←	10: 9.9 →	10: 9.9 →	
Series	103.9	Series	104.1	
	523.1		627.2	

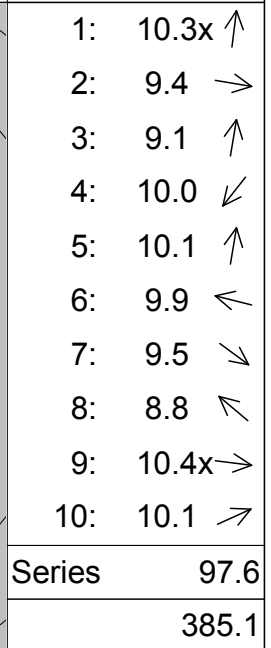
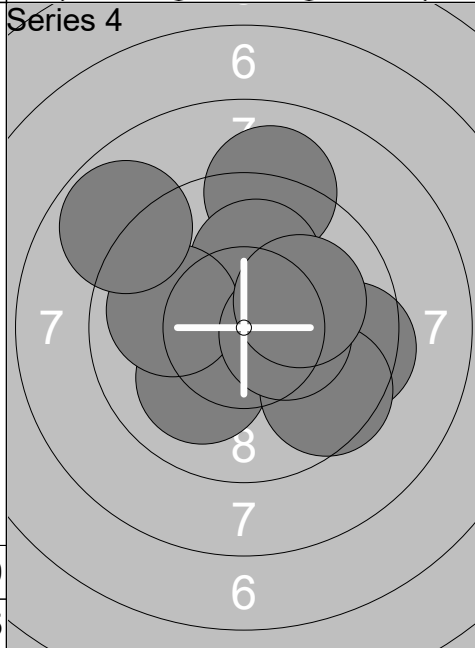
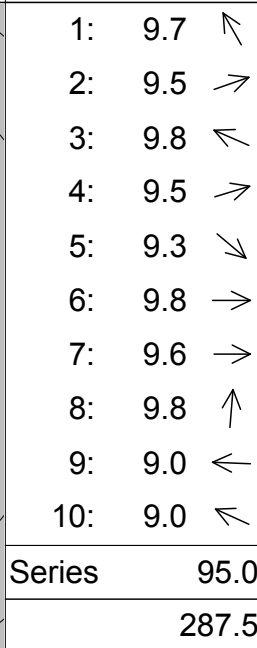
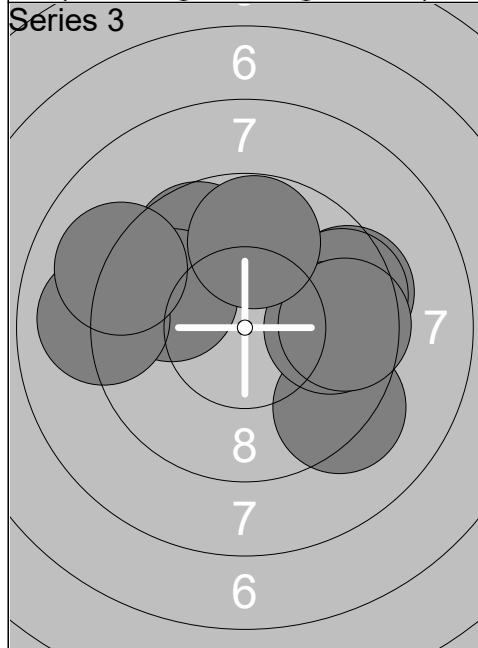
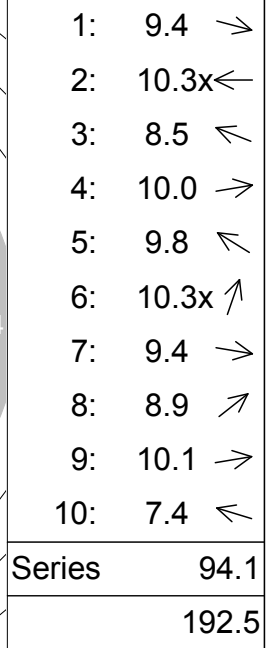
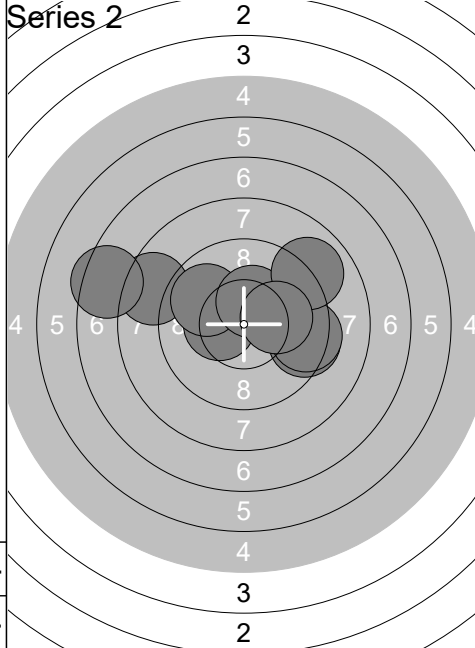
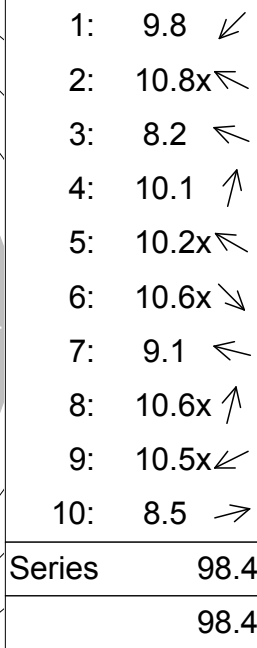
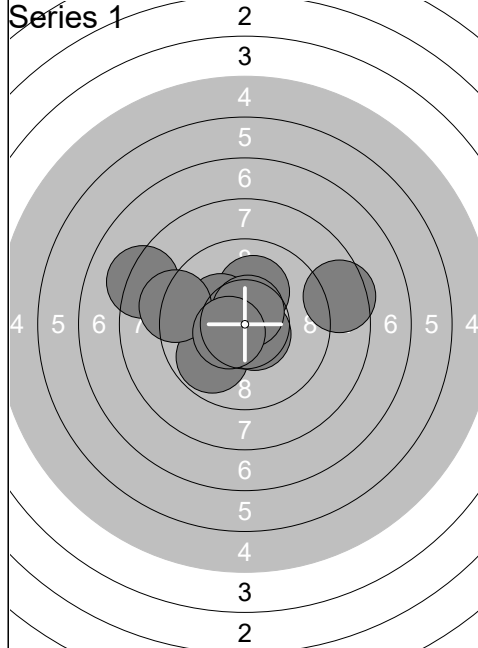

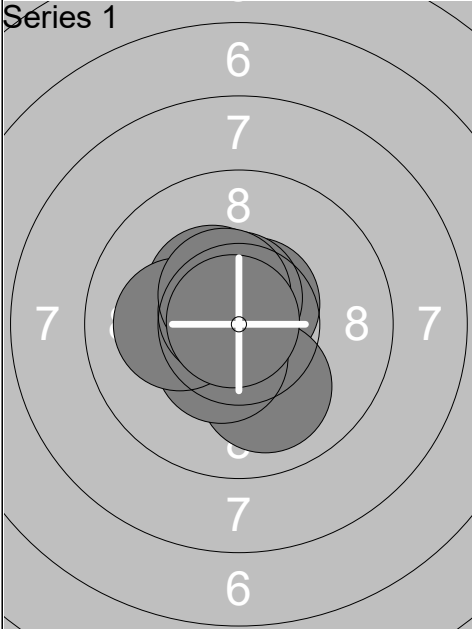
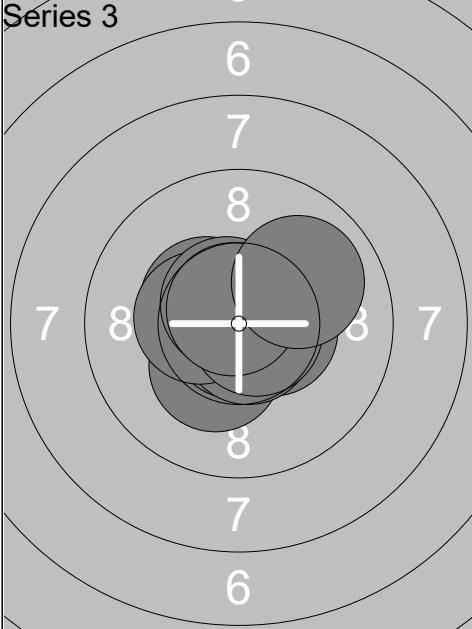
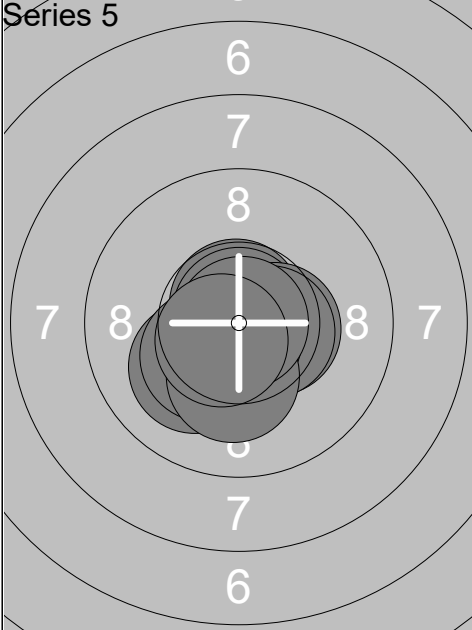
Relay	Lane	Rikke Mæng Ibsen					
1	17	1 Air Qualification		DEN	W	Rifle	
17.02.2023		DENMARK OPEN AIR 2023 DAY1		Danmark Open Air 2023			
Series 1				1: 10.6x ↗ 2: 10.3x ↘ 3: 10.5x ↓ 4: 10.0 ↓ 5: 10.4x ↘ 6: 10.1 ← 7: 10.6x ↑ 8: 10.6x ↘ 9: 10.5x ↗ 10: 10.8x ↖		Series 2	
Series 3				1: 10.5x → 2: 10.4x ↖ 3: 10.3x ↘ 4: 10.8x ↓ 5: 10.7x ↘ 6: 10.4x ← 7: 10.7x → 8: 10.6x ↗ 9: 10.7x ↗ 10: 9.9 ↗		Series 4	
Series 5				1: 10.7x ↑ 2: 10.8x ↑ 3: 10.4x → 4: 10.5x → 5: 10.1 ↘ 6: 10.7x ↓ 7: 10.3x ↘ 8: 10.2x ↓ 9: 10.9x → 10: 10.6x ↘		Series 6	
Series 1		Series		104.4		Series	
Series 3		Series		105.0		Series	
Series 5		Series		105.2		Series	
Series 1		104.4		208.5		104.1	
Series 3		313.5		419.4		208.5	
Series 5		524.6		630.2		104.1	

Relay	Lane	Amanda Karlsson		
1	19	1 Air Qualification	SWE	W Rifle
17.02.2023		DENMARK OPEN AIR 2023 DAY1		Danmark Open Air 2023
Series 1 	1: 10.8x →	Series 2 	1: 10.8x ↓	
	2: 10.0 ↓		2: 10.7x ↑	
	3: 10.7x →		3: 10.4x ↖	
	4: 10.1 ↑		4: 10.2x ↖	
	5: 10.1 ↓		5: 10.6x ↑	
	6: 10.7x ↗		6: 10.7x ↖	
	7: 10.5x ↖		7: 10.6x ↗	
	8: 10.7x →		8: 10.6x ↓	
	9: 10.1 ↑		9: 9.8 →	
	10: 9.9 ↖		10: 9.9 ←	
	Series 103.6	Series 104.3		
	103.6		207.9	
Series 3 	1: 10.0 ↑	Series 4 	1: 10.3x ↗	
	2: 10.3x ↗		2: 10.2x ←	
	3: 10.0 ↓		3: 10.5x ←	
	4: 10.6x ↑		4: 10.6x ↓	
	5: 10.2x ↑		5: 10.1 →	
	6: 10.4x ←		6: 9.9 ↗	
	7: 10.2x →		7: 10.4x ↗	
	8: 10.4x ↖		8: 9.5 ↗	
	9: 10.2x ↖		9: 10.2x ↗	
	10: 10.4x ↗		10: 10.6x ↓	
	Series 102.7	Series 102.3		
	310.6		412.9	
Series 5 	1: 10.4x ←	Series 6 	1: 10.3x →	
	2: 10.8x ↓		2: 10.4x ↗	
	3: 10.7x ↗		3: 10.6x ↑	
	4: 10.2x →		4: 10.6x ←	
	5: 10.4x →		5: 10.7x ↗	
	6: 10.8x →		6: 10.4x ↑	
	7: 10.7x ↓		7: 10.6x ←	
	8: 10.0 ↑		8: 10.5x ↓	
	9: 10.5x ↖		9: 10.2x ↓	
	10: 10.6x ←		10: 10.1 ↓	
	Series 105.1	Series 104.4		
	518.0		622.4	

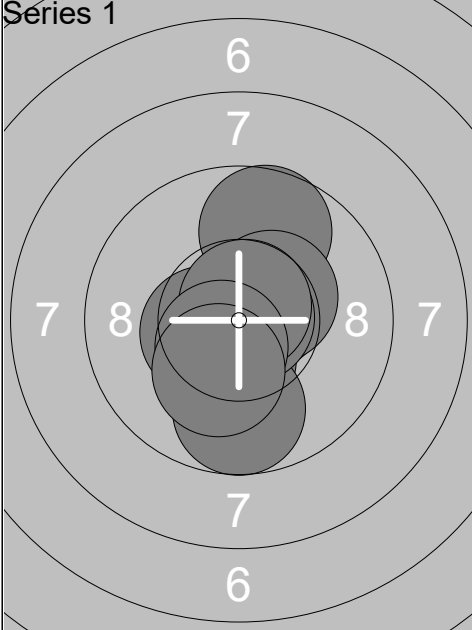
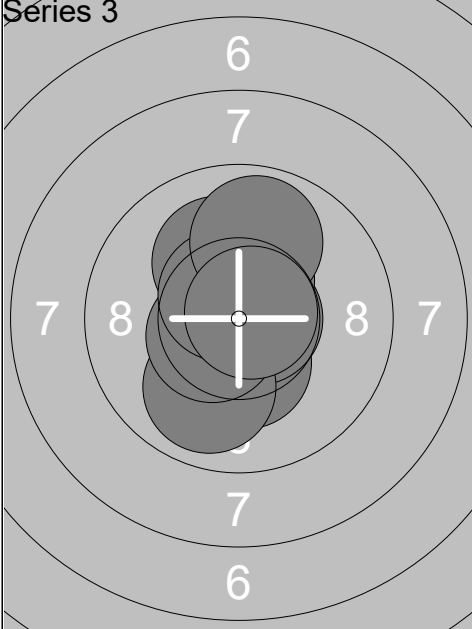
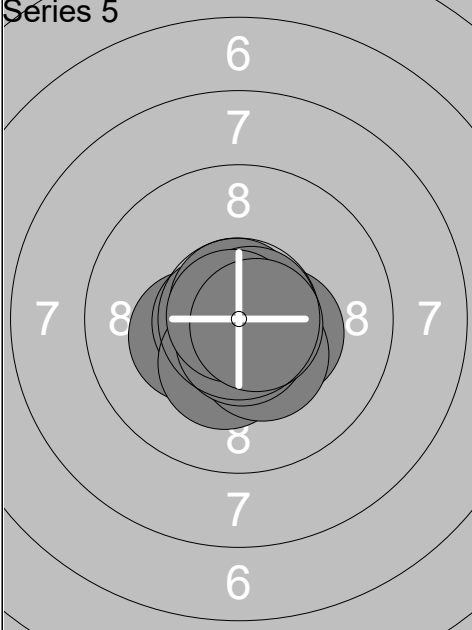
Relay	Lane	Emma Koch			
1	20	DEN		W Rifle	
17.02.2023		DENMARK OPEN AIR 2023 DAY1		Danmark Open Air 2023	
Series 1		1: 10.4x ↓ 2: 10.6x ↗ 3: 9.7 ↑ 4: 9.7 ↓ 5: 10.5x ← 6: 10.4x ↗ 7: 10.8x → 8: 10.7x ↑ 9: 10.5x ↓ 10: 10.2x ↓		Series 2 1: 10.6x ↓ 2: 10.6x → 3: 9.8 ↓ 4: 10.2x ↓ 5: 10.1 ↖ 6: 10.6x ↖ 7: 10.3x ← 8: 10.6x ↖ 9: 10.5x ↖ 10: 10.3x →	
		Series 103.5		Series 103.6	
		103.5		207.1	
Series 3		1: 10.3x ↓ 2: 10.7x → 3: 9.9 ↓ 4: 10.5x ← 5: 10.4x ↑ 6: 10.4x ↑ 7: 10.1 ↑ 8: 10.5x ↖ 9: 9.9 ↑ 10: 10.8x ↗		Series 4 1: 10.7x ↖ 2: 10.7x ↓ 3: 10.3x ↓ 4: 10.5x ↓ 5: 10.3x ← 6: 10.7x ↑ 7: 10.5x → 8: 10.7x ← 9: 10.3x → 10: 10.6x ↓	
		Series 103.5		Series 105.3	
		310.6		415.9	
Series 5		1: 10.3x ← 2: 10.6x ← 3: 10.4x → 4: 10.3x ↓ 5: 10.7x ↑ 6: 10.3x ↓ 7: 10.6x ↓ 8: 10.7x ↗ 9: 10.8x ↖ 10: 10.7x →		Series 6 1: 9.5 ↓ 2: 10.1 ↓ 3: 10.5x ↑ 4: 10.1 ↗ 5: 10.8x → 6: 10.2x ↓ 7: 10.4x ↓ 8: 10.2x ↑ 9: 10.2x ↖ 10: 10.7x ↑	
		Series 105.4		Series 102.7	
		521.3		624.0	

Relay	Lane	Anna Skade Nielsen		
1	21	DEN		W Rifle
17.02.2023		DENMARK OPEN AIR 2023 DAY1		Danmark Open Air 2023
Series 1		1: 10.9x → 2: 10.3x ↑ 3: 10.8x ↑ 4: 10.6x ↑ 5: 10.4x ↗ 6: 10.9x ↗ 7: 10.7x → 8: 10.5x → 9: 10.0 ↗ 10: 10.1 ←		Series 2
				1: 10.8x ↓ 2: 10.3x ↘ 3: 9.8 ↖ 4: 10.6x ← 5: 10.8x ← 6: 10.4x ↘ 7: 10.6x ↑ 8: 10.3x ← 9: 10.7x ← 10: 10.6x ↑
Series		105.2		Series
		105.2		210.1
Series 3		1: 10.5x ← 2: 10.4x ← 3: 9.8 ↖ 4: 10.0 ↖ 5: 10.4x → 6: 10.8x → 7: 10.1 ↘ 8: 10.7x ↑ 9: 10.8x ↗ 10: 10.5x ↓		Series 4
				1: 10.3x → 2: 10.6x ↓ 3: 10.6x ← 4: 10.5x ← 5: 10.6x ↑ 6: 10.6x ← 7: 10.7x ↘ 8: 10.7x ↗ 9: 10.7x ↘ 10: 10.5x ↓
Series		104.0		Series
		314.1		419.9
Series 5		1: 10.7x ↓ 2: 10.8x ↘ 3: 10.7x ↗ 4: 10.7x ↑ 5: 10.4x → 6: 10.6x ↗ 7: 10.9x ↓ 8: 10.4x → 9: 10.6x → 10: 10.6x ↗		Series 6
				1: 10.1 → 2: 10.6x ↘ 3: 10.3x → 4: 10.6x ↘ 5: 10.4x ↑ 6: 10.6x ← 7: 10.2x ↑ 8: 10.6x ← 9: 10.4x ← 10: 10.0 ↖
Series		106.4		Series
		526.3		630.1

Relay	Lane	Manon Smeets			
1	22	NED		W Rifle	
17.02.2023		DENMARK OPEN AIR 2023 DAY1		Danmark Open Air 2023	
Series 1		1: 10.4x ↑ 2: 10.6x → 3: 10.2x → 4: 10.7x → 5: 10.3x → 6: 9.8 ↗ 7: 10.2x ↙ 8: 9.8 ↖ 9: 10.7x ← 10: 10.0 → Series 102.7 102.7		Series 2 1: 9.1 ↙ 2: 10.4x → 3: 10.5x ↖ 4: 10.4x → 5: 10.6x ↙ 6: 10.2x ↑ 7: 10.0 ← 8: 10.3x ↓ 9: 10.0 ↖ 10: 9.7 → Series 101.2 203.9	
Series 3		1: 10.5x ↑ 2: 10.3x → 3: 10.8x ↓ 4: 10.6x ↓ 5: 10.2x ↘ 6: 10.1 ← 7: 9.9 → 8: 10.5x ↗ 9: 10.8x ↑ 10: 10.5x ↗ Series 104.2 308.1		Series 4 1: 9.0 ← 2: 10.8x ↙ 3: 9.9 ← 4: 10.5x → 5: 10.1 ↓ 6: 10.7x ↗ 7: 10.6x ↗ 8: 10.6x ← 9: 10.4x → 10: 10.7x → Series 103.3 411.4	
Series 5		1: 10.3x ↑ 2: 10.5x ↙ 3: 10.8x ↗ 4: 10.6x → 5: 10.7x ↙ 6: 10.0 ↓ 7: 10.6x → 8: 9.6 → 9: 10.6x → 10: 10.4x → Series 104.1 515.5		Series 6 1: 10.3x ↖ 2: 10.6x ↗ 3: 10.5x ↑ 4: 10.7x ↖ 5: 10.3x ↗ 6: 10.2x ↓ 7: 10.6x ↙ 8: 9.8 ← 9: 10.1 ↖ 10: 9.8 ← Series 102.9 618.4	

Relay	Lane	Joëlle van Aalderen			
1	23	NED		W	Rifle
17.02.2023		DENMARK OPEN AIR 2023 DAY1		Danmark Open Air 2023	
Series 1		1: 9.7 ↖	Series 2		1: 10.3x ↗
		2: 10.7x ↓		2: 9.8 →	
		3: 9.8 ↑		3: 9.9 →	
		4: 10.0 ↓		4: 10.4x ←	
		5: 10.2x →		5: 9.9 ↓	
		6: 10.2x ←		6: 10.2x ↑	
		7: 10.2x ↓		7: 10.7x ↓	
		8: 8.6 →		8: 9.6 ←	
		9: 9.8 ↓		9: 9.3 ↘	
		10: 10.0 ↗		10: 10.1 ↗	
	Series	99.2	Series	100.2	
		99.2		199.4	
Series 3		1: 10.3x ←	Series 4		1: 9.1 →
		2: 9.6 ←		2: 10.8x ←	
		3: 9.7 →		3: 9.8 ↓	
		4: 9.2 ←		4: 9.3 →	
		5: 9.6 →		5: 9.7 ↘	
		6: 10.1 ↗		6: 10.3x ↑	
		7: 9.5 ↖		7: 9.9 ←	
		8: 9.9 ↓		8: 9.9 ↗	
		9: 10.5x ↓		9: 10.4x ←	
		10: 9.3 ↑		10: 9.8 ←	
	Series	97.7	Series	99.0	
		297.1		396.1	
Series 5		1: 10.4x ←	Series 6		1: 10.2x ↖
		2: 9.5 →		2: 10.7x ←	
		3: 9.9 ↗		3: 9.6 ←	
		4: 9.4 →		4: 10.1 ↑	
		5: 10.1 →		5: 10.3x ↓	
		6: 8.9 ←		6: 9.9 ↗	
		7: 9.8 →		7: 10.1 →	
		8: 9.9 ↓		8: 9.6 ↘	
		9: 10.0 ↓		9: 9.7 ↗	
		10: 10.0 ↖		10: 9.1 →	
	Series	97.9	Series	99.3	
		494.0		593.3	

Relay	Lane	Emma Åkesson			
1	24	SWE		W	Rifle
17.02.2023		DENMARK OPEN AIR 2023 DAY1		Danmark Open Air 2023	
Series 1		1: 10.6x ↖	Series 2		1: 10.4x ↗
		2: 9.9 ↘			2: 10.4x ↙
		3: 10.2x →			3: 10.7x →
		4: 10.2x ↗			4: 10.7x ↘
		5: 10.1 ↑			5: 9.9 ↓
		6: 10.5x ↓			6: 10.4x ↓
		7: 10.7x ↑			7: 10.3x ↓
		8: 9.9 ↓			8: 10.1 ↓
		9: 10.3x ↙			9: 10.1 ↘
		10: 10.5x ↓			10: 10.3x ↗
		Series 102.9		Series 103.3	
		102.9		206.2	
Series 3		1: 10.5x →	Series 4		1: 10.6x →
		2: 10.2x ↑			2: 10.1 ↘
		3: 10.4x ↓			3: 10.6x ↘
		4: 10.6x ↗			4: 10.4x ↙
		5: 9.9 ↓			5: 10.3x ↙
		6: 10.6x ↙			6: 10.8x ↗
		7: 10.1 ↖			7: 10.3x ↓
		8: 10.6x →			8: 9.6 ↓
		9: 9.8 ↓			9: 10.5x →
		10: 9.9 ↓			10: 10.8x ↙
		Series 102.6		Series 104.0	
		308.8		412.8	
Series 5		1: 10.4x ↓	Series 6		1: 10.7x ↙
		2: 10.6x ↗			2: 10.3x ↘
		3: 10.2x ↗			3: 10.7x ↘
		4: 10.7x ↗			4: 10.2x →
		5: 10.5x ↘			5: 10.8x ↘
		6: 10.9x ↓			6: 10.5x ↓
		7: 10.3x ↙			7: 10.2x ↙
		8: 10.6x ↙			8: 10.6x ↖
		9: 10.8x ↖			9: 10.2x ↗
		10: 10.6x ↙			10: 9.3 ↗
		Series 105.6		Series 103.5	
		518.4		621.9	

Relay	Lane	Justine Allezard			
1	25	FRA		W	Rifle
17.02.2023		DENMARK OPEN AIR 2023 DAY1		Danmark Open Air 2023	
Series 1		1: 10.4x ↓	Series 2		1: 10.6x ↗
		2: 10.4x →			2: 10.7x ↗
		3: 10.0 ↓			3: 10.7x ↓
		4: 10.6x ↗			4: 10.7x →
		5: 10.4x →			5: 9.5 →
		6: 10.3x ↗			6: 10.5x ↗
		7: 10.3x →			7: 10.8x ↑
		8: 10.7x →			8: 10.5x ↙
		9: 10.6x ↑			9: 10.2x ↓
		10: 10.2x ↙			10: 10.7x ↙
	Series	103.9	Series	104.9	
		103.9		208.8	
Series 3		1: 10.5x ↗	Series 4		1: 10.3x →
		2: 10.6x ←			2: 10.7x ↗
		3: 10.1 ↗			3: 10.7x ↓
		4: 10.4x ↙			4: 10.3x ←
		5: 10.4x ↓			5: 10.4x ↙
		6: 10.8x →			6: 10.6x ↘
		7: 9.9 ↓			7: 10.6x ↗
		8: 10.7x →			8: 10.9x ↘
		9: 10.2x ↙			9: 10.9x
		10: 10.7x ↓			10: 10.3x ←
	Series	104.3	Series	105.7	
		313.1		418.8	
Series 5		1: 10.3x ↙	Series 6		1: 10.6x ↙
		2: 10.9x			2: 10.7x ↑
		3: 10.6x ↙			3: 10.3x ↙
		4: 10.6x ↗			4: 10.6x →
		5: 10.8x ↗			5: 10.4x ←
		6: 10.3x →			6: 10.9x ↓
		7: 10.8x ↓			7: 10.8x ↗
		8: 10.6x →			8: 10.8x ↘
		9: 10.4x ←			9: 10.4x ↗
		10: 10.9x ↘			10: 10.4x ↗
	Series	106.2	Series	105.9	
		525.0		630.9	

Relay	Lane	Helle Bertelsen		
1	26			
1 Air Qualification		DEN		W Rifle
17.02.2023		DENMARK OPEN AIR 2023 DAY1		Danmark Open Air 2023
Series 1 	1: 10.6x ↗	Series 2 	1: 10.2x ↘	
	2: 10.7x ↖		2: 10.4x ↓	
	3: 10.7x →		3: 10.3x ⇒	
	4: 10.0 ↑		4: 10.6x ⇒	
	5: 10.4x ←		5: 10.8x ↙	
	6: 10.6x ↘		6: 10.3x ↗	
	7: 10.2x ←		7: 10.6x ↖	
	8: 10.1 ↓		8: 10.9x	
	9: 10.9x ↙		9: 10.9x →	
	10: 10.3x ↑		10: 10.8x →	
	Series 104.5		Series 105.8	
	104.5		210.3	
Series 3 	1: 10.1 ↙	Series 4 	1: 10.5x →	
	2: 9.6 ←		2: 10.4x ↓	
	3: 10.3x ↙		3: 10.1 ←	
	4: 10.0 ↑		4: 10.8x ⇒	
	5: 10.5x ↓		5: 9.9 →	
	6: 10.0 ↖		6: 10.0 ↓	
	7: 10.1 ↗		7: 10.2x ↙	
	8: 9.7 ↘		8: 9.7 ↓	
	9: 10.2x →		9: 10.5x ↙	
	10: 10.6x ↓		10: 10.6x ↑	
	Series 101.1		Series 102.7	
	311.4		414.1	
Series 5 	1: 10.8x ↑	Series 6 	1: 10.1 →	
	2: 10.2x ⇒		2: 10.3x ⇒	
	3: 9.9 ←		3: 10.5x ↙	
	4: 10.6x ↙		4: 10.3x ↙	
	5: 9.8 →		5: 10.3x ↗	
	6: 10.1 ↖		6: 10.3x ↑	
	7: 10.7x ↓		7: 10.3x →	
	8: 10.3x ↖		8: 10.8x ↖	
	9: 10.7x ↑		9: 10.4x ↖	
	10: 10.5x ↓		10: 10.6x ↙	
	Series 103.6		Series 103.9	
	517.7		621.6	

Relay	Lane	Jade Bordet			
1	27	FRA		W	Rifle
17.02.2023		DENMARK OPEN AIR 2023 DAY1		Danmark Open Air 2023	
Series 1 	1: 10.5x →	Series 2 	1: 10.5x ↙		
	2: 10.4x ➤		2: 10.3x ↖		
	3: 10.3x ↑		3: 10.6x ➤		
	4: 10.2x ↓		4: 10.6x ←		
	5: 10.6x →		5: 10.4x ←		
	6: 10.3x →		6: 10.7x ↗		
	7: 10.3x ↖		7: 10.8x ↗		
	8: 10.0 ↑		8: 10.8x ↗		
	9: 10.0 ↖		9: 10.8x ↓		
	10: 10.5x ↗		10: 10.8x ↓		
Series	103.1	Series	106.3		
	103.1		209.4		
Series 3 	1: 10.4x ↑	Series 4 	1: 10.3x ↓		
	2: 10.6x ➤		2: 10.8x ↓		
	3: 10.6x ↖		3: 10.8x ↗		
	4: 10.8x ↗		4: 10.6x ↓		
	5: 10.1 ➤		5: 10.2x ↗		
	6: 10.2x ↖		6: 10.4x ↖		
	7: 10.7x ↓		7: 10.5x ↗		
	8: 10.5x ←		8: 10.3x ↗		
	9: 10.5x ↓		9: 10.7x →		
	10: 10.5x ↗		10: 10.5x ↖		
Series	104.9	Series	105.1		
	314.3		419.4		
Series 5 	1: 10.1 ↗	Series 6 	1: 10.5x ↙		
	2: 10.2x ➤		2: 10.6x →		
	3: 10.3x ↖		3: 10.1 ↗		
	4: 10.5x ↓		4: 10.3x →		
	5: 10.5x →		5: 9.7 ↓		
	6: 10.2x ↖		6: 10.2x ↗		
	7: 9.9 →		7: 10.1 ↓		
	8: 10.8x →		8: 10.3x ↙		
	9: 10.4x →		9: 10.2x ←		
	10: 10.3x ↖		10: 10.1 ➤		
Series	103.2	Series	102.1		
	522.6		624.7		

Relay	Lane	Sofie Frantsen			
1	28	DEN		W	Rifle
17.02.2023		DENMARK OPEN AIR 2023 DAY1		Danmark Open Air 2023	
Series 1 	1: 10.7x ↘	Series 2 	1: 10.7x ↘		
	2: 10.5x →		2: 10.4x ↙		
	3: 10.9x ↙		3: 9.9 ↗		
	4: 10.3x →		4: 10.5x ↗		
	5: 10.3x ↓		5: 10.6x ↙		
	6: 10.4x ↑		6: 10.6x ↗		
	7: 10.6x ↙		7: 10.3x ↗		
	8: 9.8 ↗		8: 10.9x ↑		
	9: 10.1 →		9: 9.9 →		
	10: 10.1 ←		10: 10.2x →		
	Series 103.7	Series 104.0			
	103.7		207.7		
Series 3 	1: 10.0 ↗	Series 4 	1: 10.1 →		
	2: 10.1 →		2: 9.7 →		
	3: 10.0 →		3: 10.2x ↘		
	4: 10.2x ↙		4: 10.6x →		
	5: 10.3x ↗		5: 10.7x ↑		
	6: 10.6x ↘		6: 10.1 ↗		
	7: 10.9x		7: 9.7 ↗		
	8: 10.5x ↓		8: 10.6x ↑		
	9: 10.3x ↗		9: 10.0 ↑		
	10: 10.7x ↑		10: 10.6x ↙		
	Series 103.6	Series 102.3			
	311.3		413.6		
Series 5 	1: 10.2x ↙	Series 6 	1: 10.1 →		
	2: 10.2x ↙		2: 10.7x ↑		
	3: 10.4x ↑		3: 10.7x ↓		
	4: 9.5 ↘		4: 9.7 ↘		
	5: 10.7x ↙		5: 10.7x ↓		
	6: 10.3x ↓		6: 10.1 ←		
	7: 10.0 →		7: 10.8x ↑		
	8: 10.3x ↗		8: 9.9 ↓		
	9: 10.4x ↑		9: 10.8x ↙		
	10: 9.7 ↘		10: 9.7 →		
	Series 101.7	Series 103.2			
	515.3		618.5		

Relay	Lane	Clémentine Krumm		
1	29	FRA	W	Rifle
17.02.2023	DENMARK OPEN AIR 2023 DAY1	Danmark Open Air 2023		
Series 1	1: 10.6x ↗ 2: 10.6x → 3: 10.4x → 4: 10.7x ↗ 5: 10.5x ← 6: 10.7x ↓ 7: 10.2x ↗ 8: 10.2x ↗ 9: 10.6x → 10: 10.7x → Series 105.2 105.2	Series 2	1: 10.6x ↖ 2: 10.2x ↗ 3: 10.3x ↗ 4: 10.6x ↘ 5: 10.7x ← 6: 10.1 ↘ 7: 10.9x ↓ 8: 10.6x ↖ 9: 10.8x → 10: 10.5x → Series 105.3 210.5	
Series 3	1: 10.2x → 2: 10.1 → 3: 10.6x ↘ 4: 10.8x ↗ 5: 10.5x ↗ 6: 10.7x ↗ 7: 10.6x → 8: 10.7x ↖ 9: 10.2x ← 10: 10.5x ↗ Series 104.9 315.4	Series 4	1: 10.5x ↖ 2: 10.8x ↘ 3: 10.3x ↗ 4: 10.4x ↖ 5: 10.2x ← 6: 10.6x ↘ 7: 10.3x ↗ 8: 10.2x → 9: 10.5x ← 10: 10.8x ↘ Series 104.6 420.0	
Series 5	1: 10.9x 2: 10.7x → 3: 10.4x → 4: 10.7x ↖ 5: 10.9x ↗ 6: 10.7x ↗ 7: 9.6 ↗ 8: 10.4x ↗ 9: 10.5x ↗ 10: 10.0 ↘ Series 104.8 524.8	Series 6	1: 10.3x ↘ 2: 10.6x ↗ 3: 10.1 → 4: 10.5x ↘ 5: 10.5x ← 6: 10.5x ↖ 7: 10.4x ↗ 8: 10.5x ↗ 9: 10.8x ↗ 10: 10.1 ↖ Series 104.3 629.1	

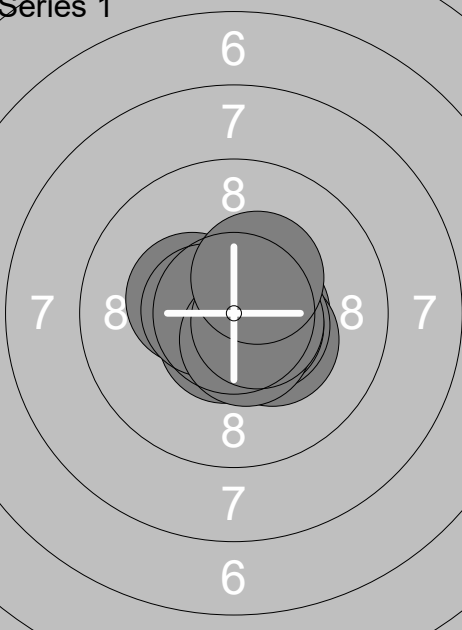
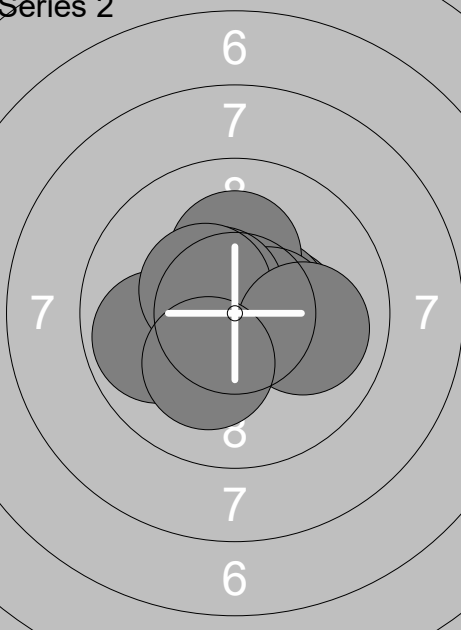
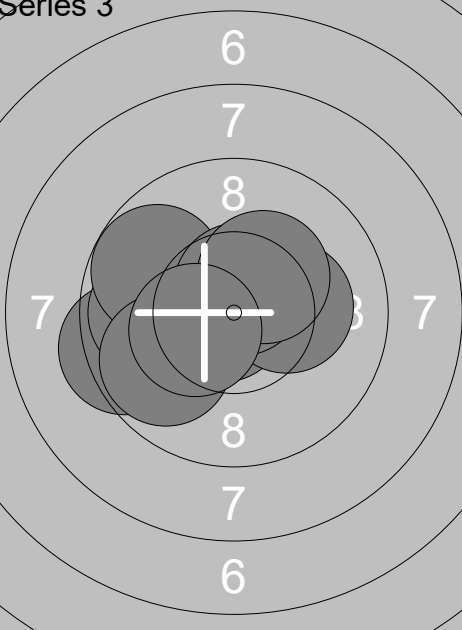
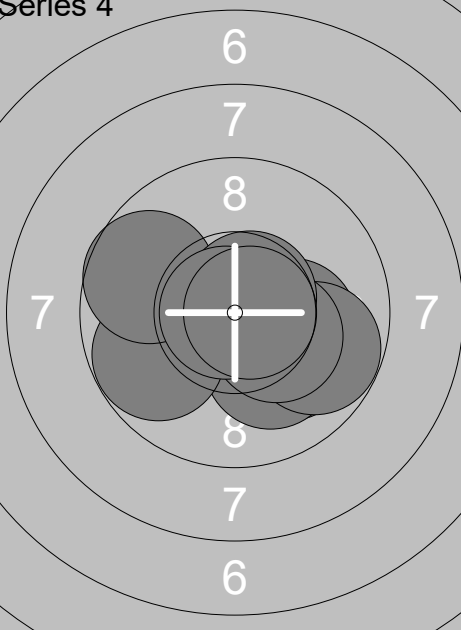
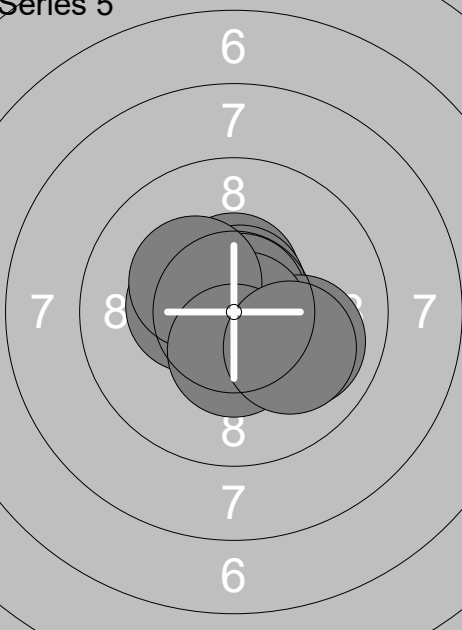
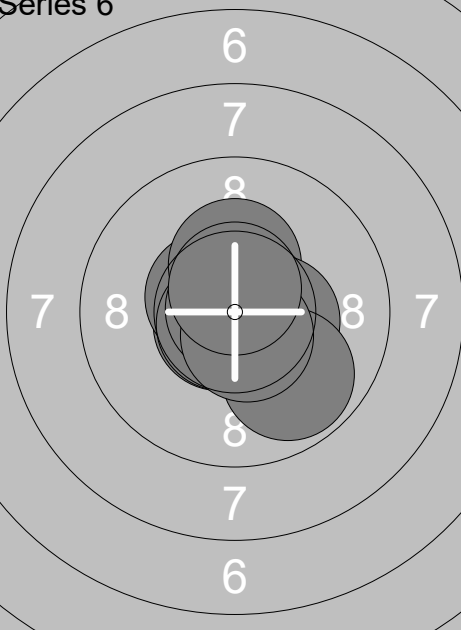
Relay	Lane	Competitor Name			
1	30	Josefine Laursen			
1 Air Qualification		DEN	W	Rifle	
17.02.2023		DENMARK OPEN AIR 2023 DAY1	Danmark Open Air 2023		
Series 1		1: 10.5x →	Series 2		1: 10.2x ←
		2: 10.6x ↓		2: 10.4x →	
		3: 10.3x ←		3: 10.5x →	
		4: 10.3x ↘		4: 10.2x ↑	
		5: 10.6x ←		5: 10.5x →	
		6: 10.5x →		6: 10.5x ↖	
		7: 10.6x ↘		7: 9.8 ←	
		8: 10.5x ↓		8: 10.4x ↖	
		9: 10.6x →		9: 10.0 →	
		10: 10.4x ↗		10: 10.2x ↓	
	Series	104.9	Series	102.7	
		104.9		207.6	
Series 3		1: 10.8x ←	Series 4		1: 10.0 ↘
		2: 9.4 ←		2: 10.1 →	
		3: 9.9 ←		3: 10.1 ↓	
		4: 10.2x →		4: 9.7 ↘	
		5: 10.4x ←		5: 9.7 ←	
		6: 9.7 ←		6: 10.3x ↘	
		7: 10.6x ↑		7: 9.7 ←	
		8: 10.3x ↗		8: 10.7x ↗	
		9: 9.8 ←		9: 10.8x ←	
		10: 10.3x ←		10: 10.7x →	
	Series	101.4	Series	101.8	
		309.0		410.8	
Series 5		1: 10.3x ←	Series 6		1: 10.7x ↙
		2: 10.5x ↑		2: 10.6x ↖	
		3: 10.6x ↑		3: 10.7x ↙	
		4: 10.7x ↓		4: 10.3x ↑	
		5: 10.8x ↗		5: 10.3x ↘	
		6: 10.0 →		6: 10.9x ↖	
		7: 10.8x ↘		7: 10.4x →	
		8: 10.3x ↖		8: 9.8 ↓	
		9: 10.4x ↓		9: 10.5x ↓	
		10: 10.0 ↘		10: 10.6x ↑	
	Series	104.4	Series	104.8	
		515.2		620.0	