

Relay 1 Lane 1 **Emil Strandgaard**

3 Air Final Pistol Men DEN Mp

19.02.2023 DENMARK OPEN AIR 2023 DAY3 Danmark Open Air 2023

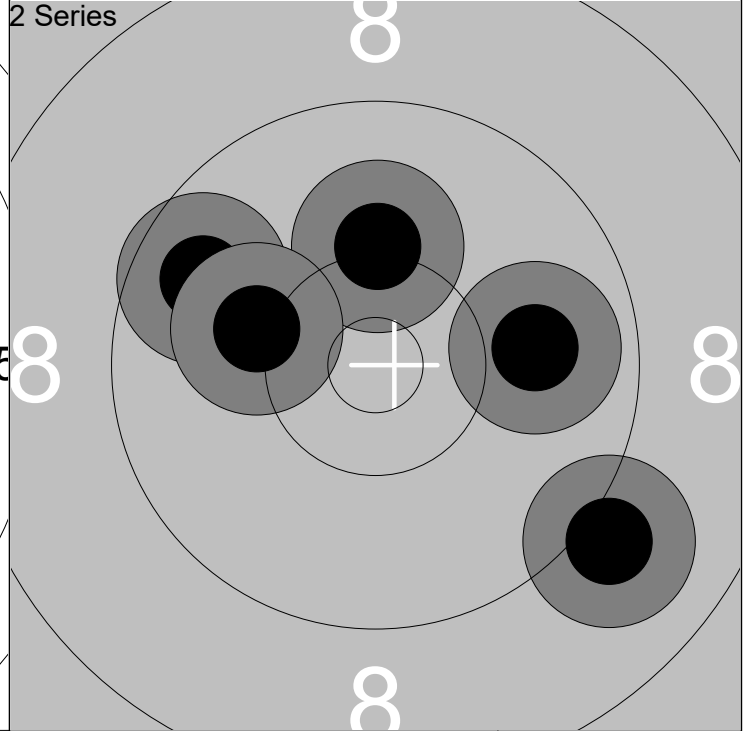
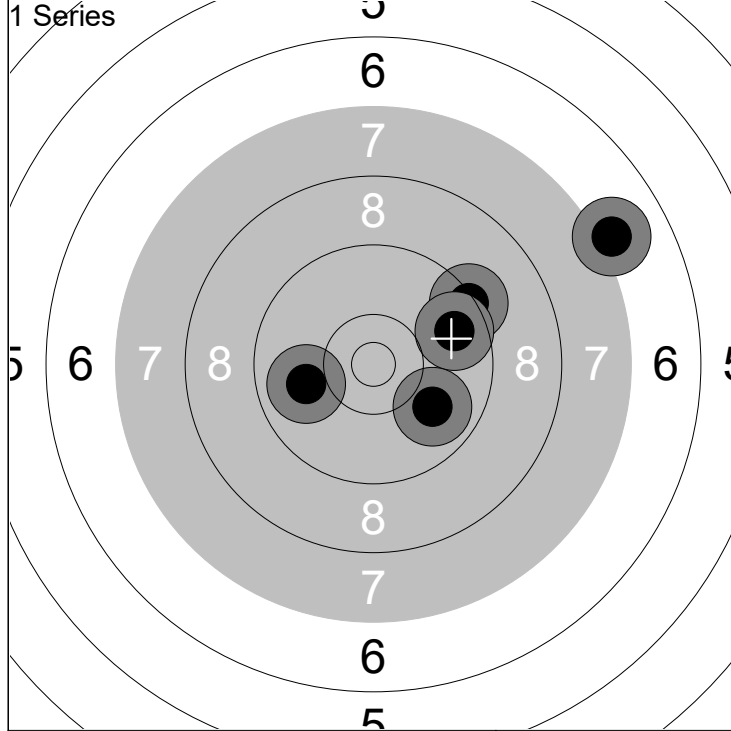

1:	7.0	↗
2:	9.3	↗
3:	9.7	→
4:	9.9	←
5:	9.9	↘

Series	45.8
	45.8

1:	9.7	↖
2:	9.9	→
3:	10.2	↑
4:	9.0	↘
5:	10.1	←

Series	48.9
	94.7

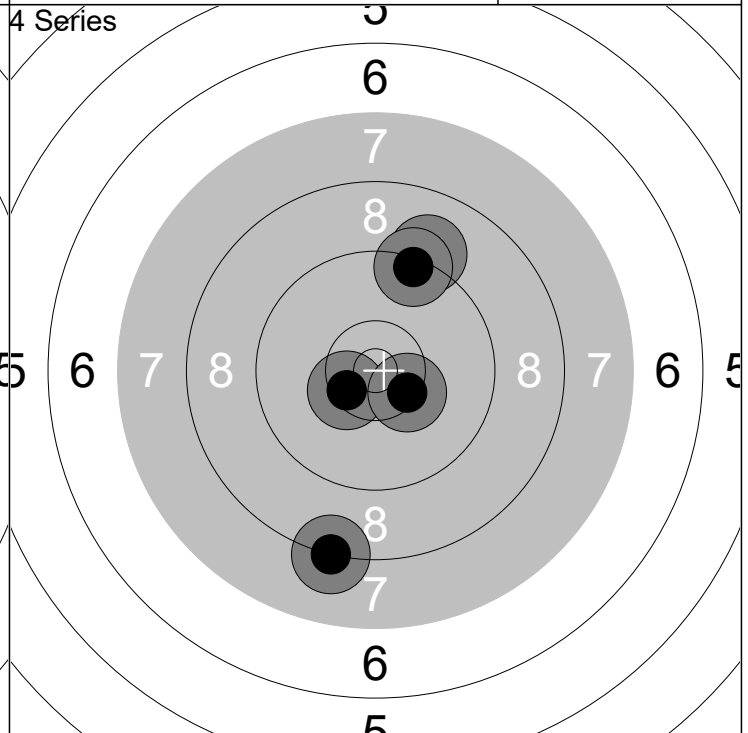
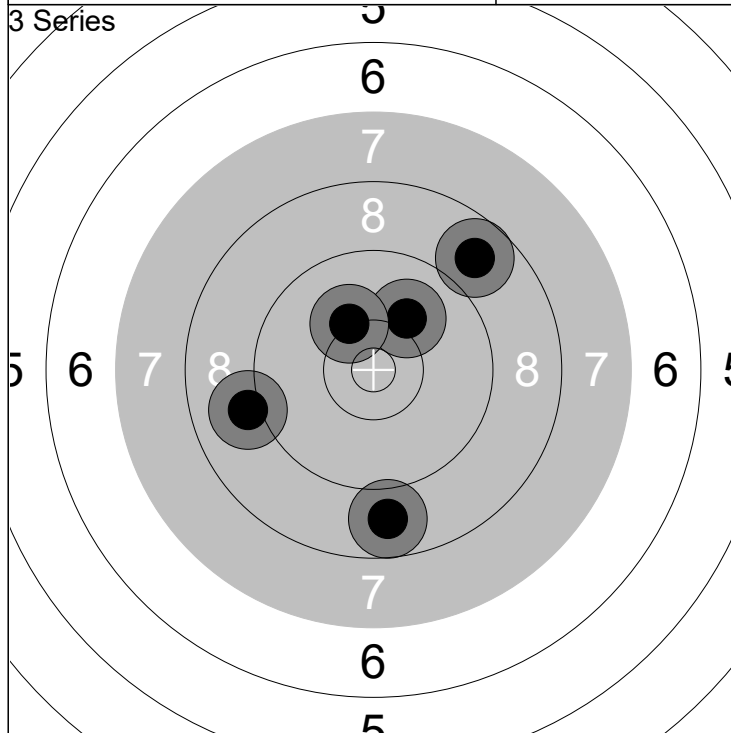

1:	8.8	↓
2:	10.1	↗
3:	10.2	↖
4:	9.0	←
5:	8.8	↗

Series	46.9
	141.6

1:	10.4x	↖
2:	9.1	↗
3:	10.4x	↘
4:	8.2	↓
5:	9.4	↗

Series	47.5
	189.1

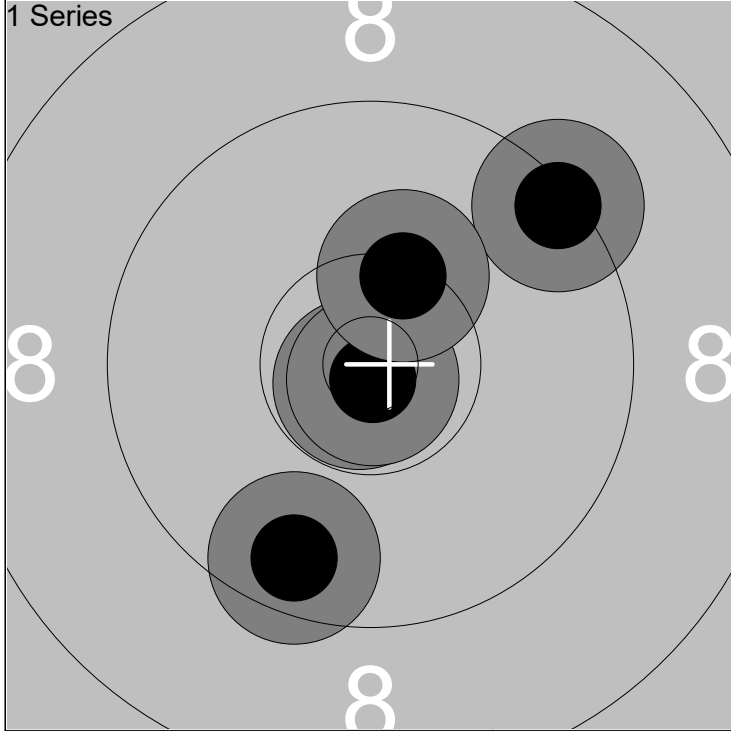

1:	9.3	↗
2:	10.8x	↘
3:	9.6	↘
4:	10.8x	↘
5:	10.3	↗

Series	50.8
	50.8

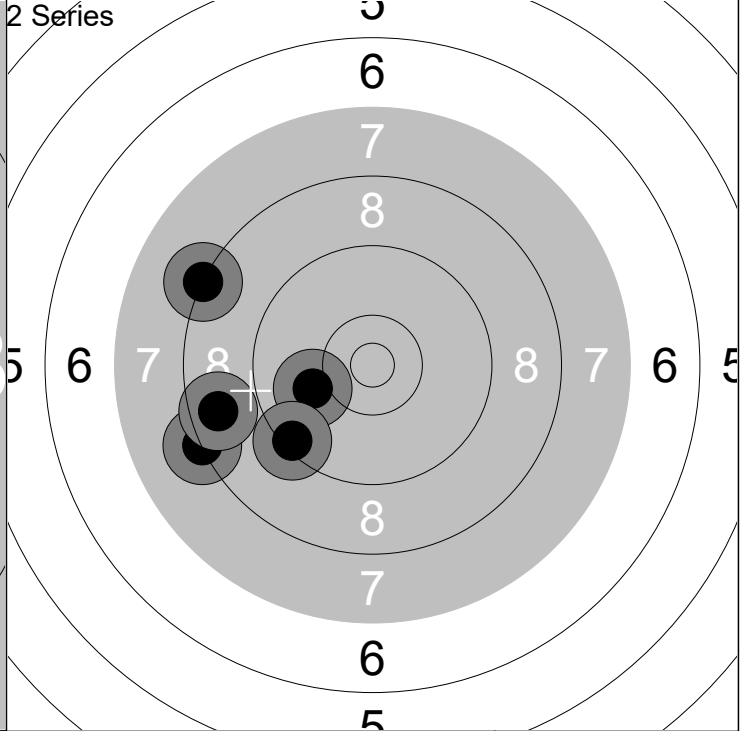

1:	8.2	←
2:	8.2	↖
3:	10.0	←
4:	8.6	←
5:	9.4	↘

Series	44.4
	95.2

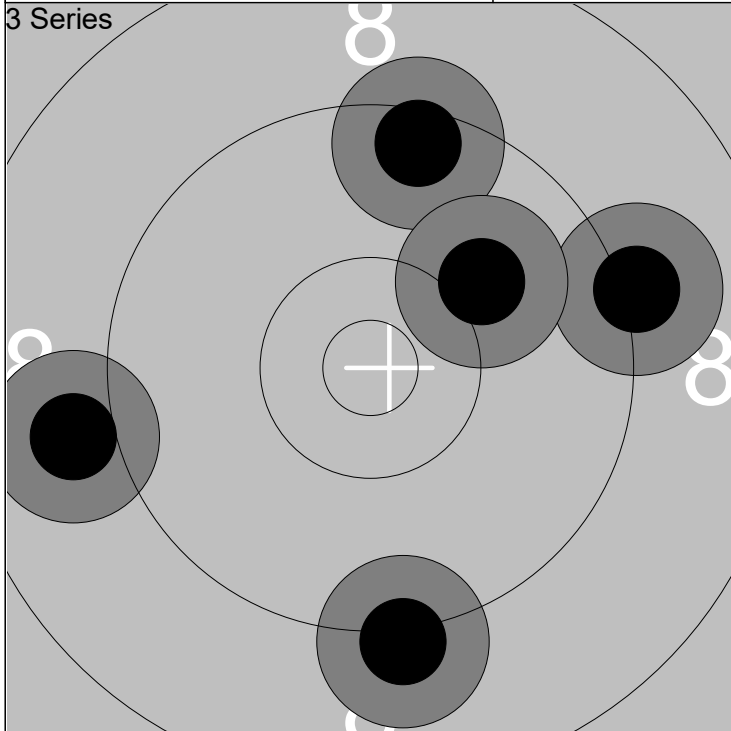

1:	9.4	↑
2:	9.1	→
3:	9.0	←
4:	10.0	↗
5:	9.1	↘

Series	46.6
	141.8

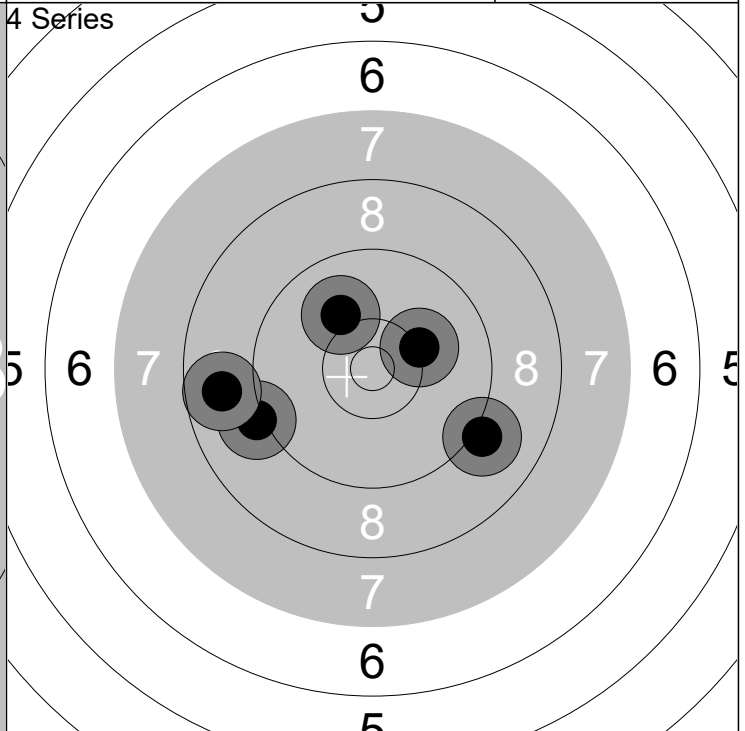

1:	9.1	←
2:	10.2	↗
3:	9.1	↘
4:	10.0	↗
5:	8.8	←

Series	47.2
	189.0

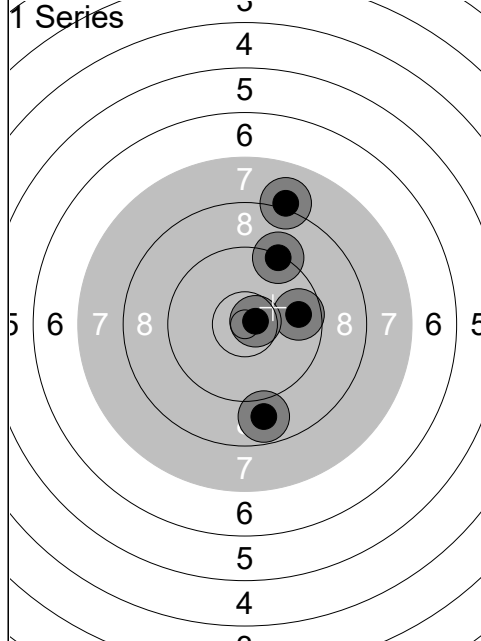

1:	8.1	↗
2:	9.7	→
3:	10.7x	→
4:	9.3	↗
5:	8.8	↓
Series		46.6
		46.6

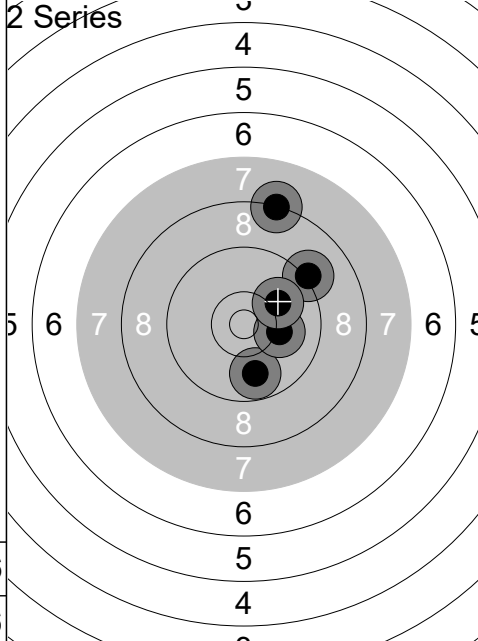

1:	8.2	↗
2:	9.8	↓
3:	9.2	↗
4:	10.1	→
5:	10.0	↗
Series		47.3
		93.9

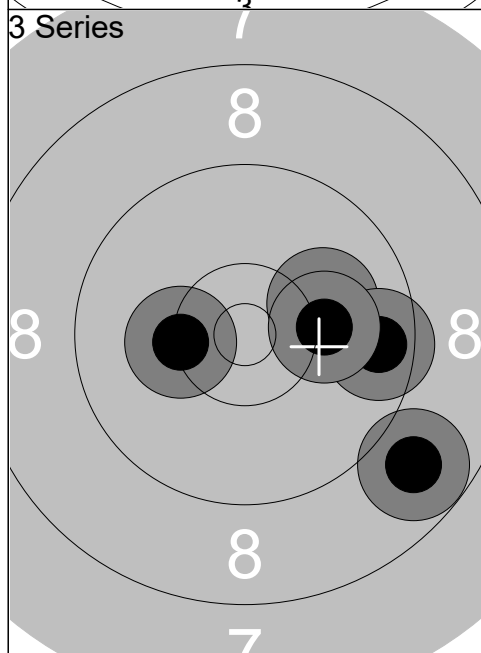

1:	8.8	↘
2:	10.1	→
3:	10.3	←
4:	9.6	→
5:	10.1	→
Series		48.9
		142.8

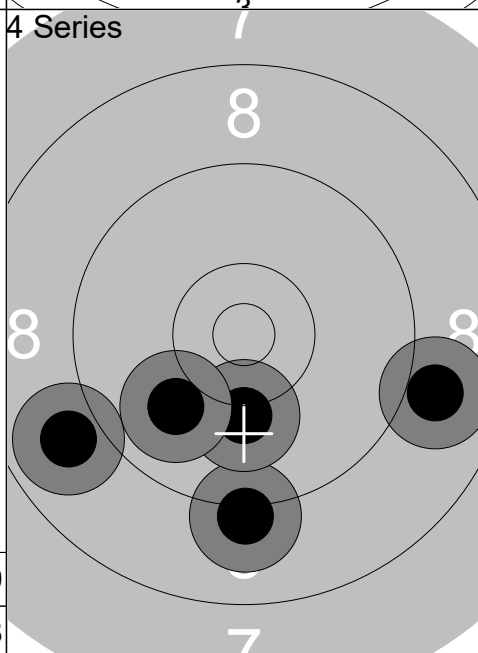

1:	8.9	↙
2:	9.1	↓
3:	10.1	↓
4:	8.9	→
5:	9.9	↙
Series		46.9
		189.7

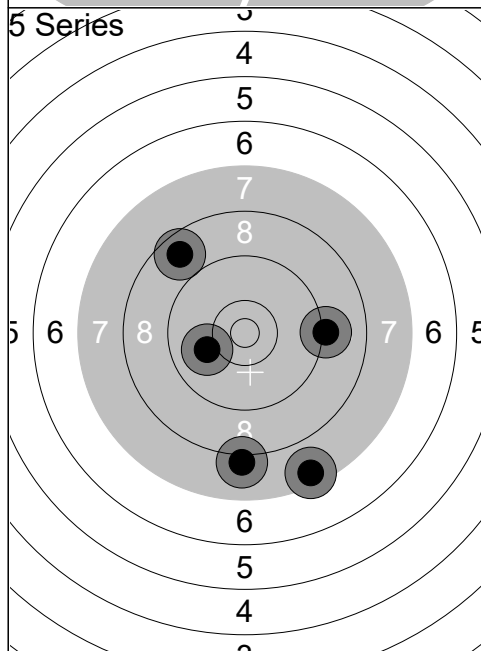

1:	8.7	↖
2:	8.1	↓
3:	10.0	←
4:	9.1	→
5:	7.5	↓
Series		43.4
		233.1

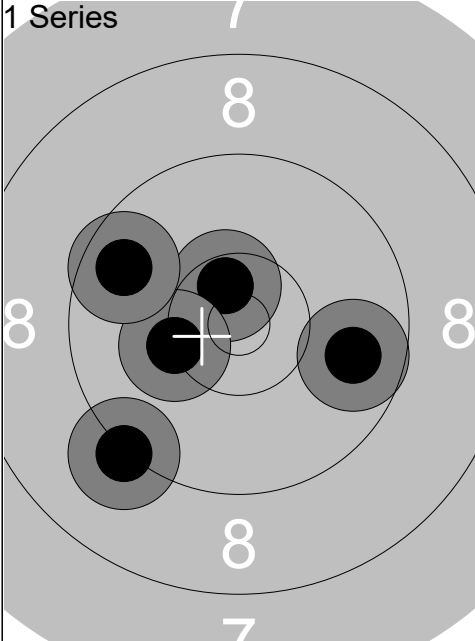
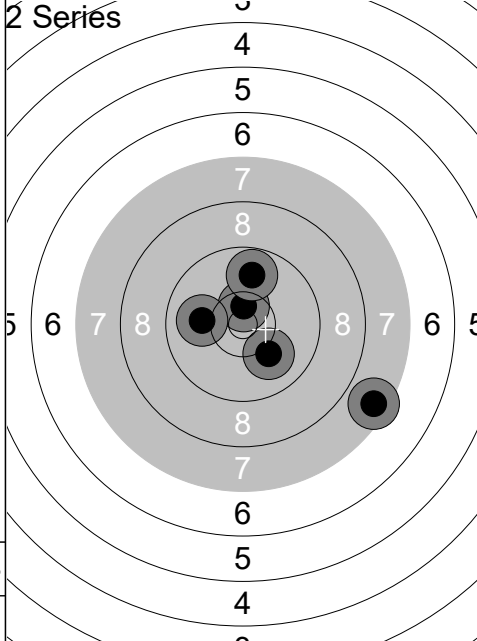
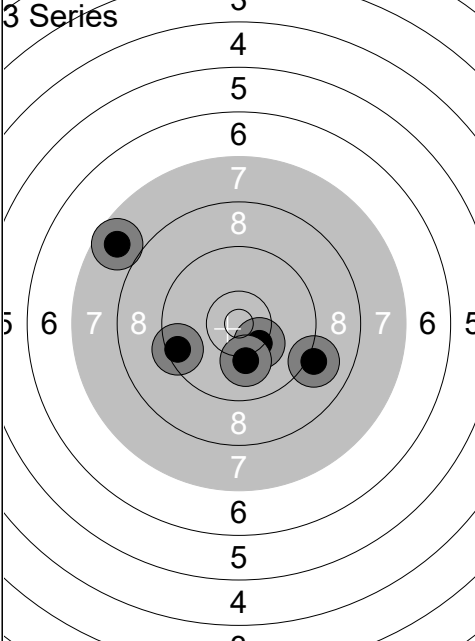
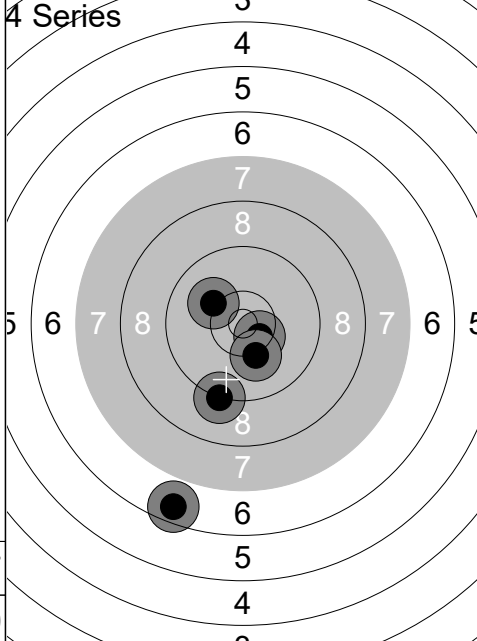
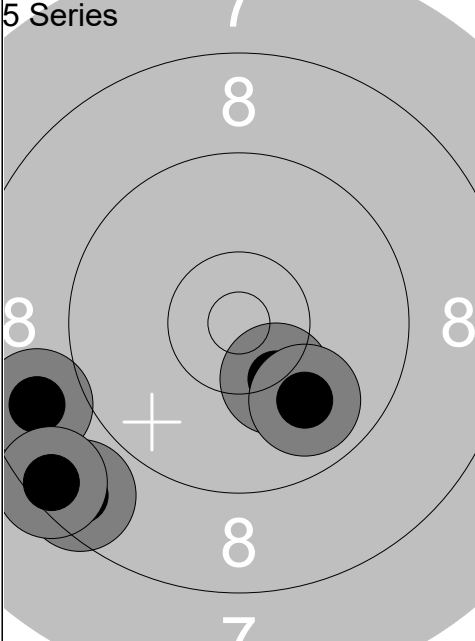
Relay	Lane	Participant Name			
1	4	Martin Brovn Nielsen			
3 Air Final Pistol Men		DEN	Mp		
19.02.2023		DENMARK OPEN AIR 2023 DAY3	Danmark Open Air 2023		
1 Series		1: 10.5x ↗ 2: 9.8 ➡ 3: 10.3 ← 4: 9.2 ↘ 5: 9.6 ↖	2 Series		1: 7.5 ➡ 2: 10.5x ↑ 3: 10.1 ↘ 4: 10.0 ← 5: 9.8 ↑
Series		49.4	Series		47.9
		49.4			97.3
3 Series		1: 9.5 ← 2: 9.1 ➡ 3: 7.7 ↖ 4: 10.3 ↘ 5: 10.1 ↓	4 Series		1: 10.5x ↘ 2: 10.1 ↖ 3: 10.2 ↓ 4: 6.6 ↓ 5: 9.2 ↓
Series		46.7	Series		46.6
		144.0			190.6
5 Series		1: 10.3 ↓ 2: 8.6 ↘ 3: 8.7 ← 4: 9.9 ↘ 5: 8.5 ↘			
Series		46.0			
		236.6			

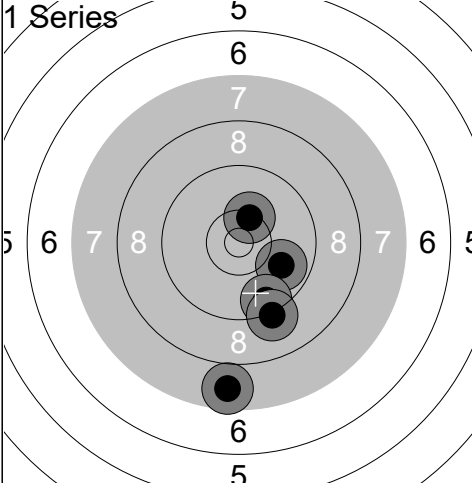
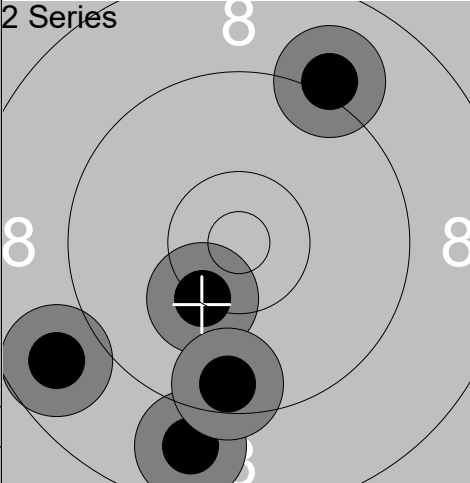
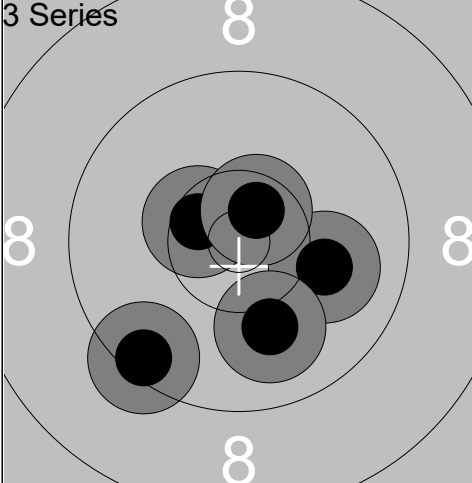
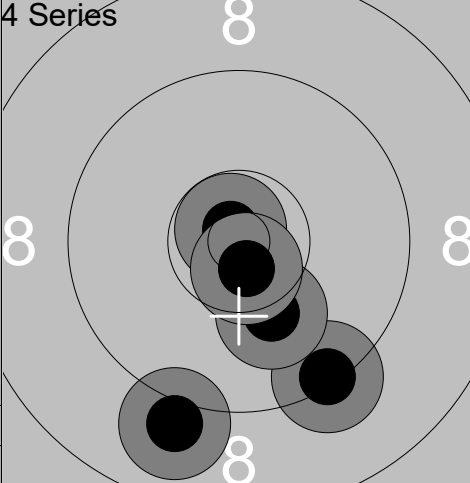
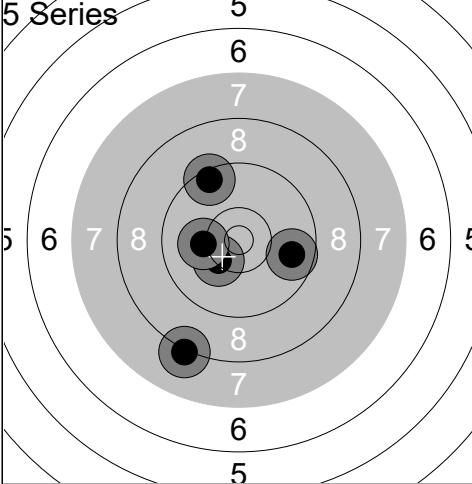
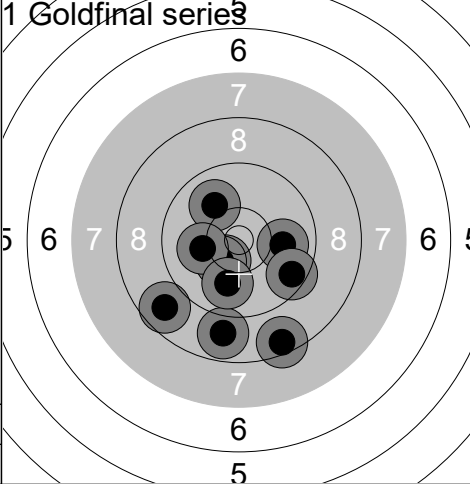
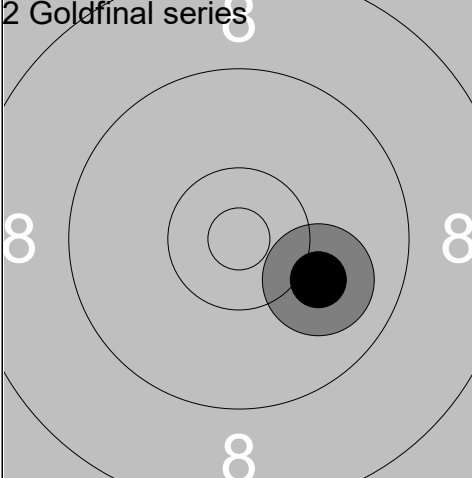
Relay	Lane	Frederik Larsen			
3 Air Final Pistol Men	DEN	Mp			
19.02.2023	DENMARK OPEN AIR 2023 DAY3	Danmark Open Air 2023			
1 Series		1: 9.9 → 2: 10.3 ↑ 3: 9.5 ↓ 4: 7.7 ↓ 5: 9.2 ↓	2 Series		1: 10.3 ↓ 2: 8.8 ↙ 3: 8.8 ↓ 4: 9.5 ↓ 5: 9.1 ↗
	Series	46.6		Series	46.5
		46.6			93.1
3 Series		1: 9.4 ↓ 2: 10.0 → 3: 10.5x ↗ 4: 10.0 ↓ 5: 10.6x ↗	4 Series		1: 9.3 ↓ 2: 10.8x ↗ 3: 9.0 ↓ 4: 10.1 ↓ 5: 10.7x ↓
	Series	50.5		Series	49.9
		143.6			193.5
5 Series		1: 10.3 ↓ 2: 10.1 ← 3: 8.2 ↓ 4: 9.7 → 5: 9.4 ↗	1 Goldfinal series		1: 10.4x ↓ 2: 8.8 ↓ 3: 10.3 ↓ 4: 8.5 ↓ 5: 10.0 ↗ 6: 10.0 → 7: 10.1 ← 8: 8.7 ↙ 9: 9.9 ↓ 10: 9.6 ↓
	Series	47.7		Series	96.3
		241.2			337.5
2 Goldfinal series		1: 10.0 →			
	Series	10.0			
		347.5			

Relay 1	Lane 6	Patrick Larsson
-------------------	------------------	------------------------

3 Air Final Pistol Men	SWE	Mp
------------------------	-----	----

19.02.2023	DENMARK OPEN AIR 2023 DAY3	Danmark Open Air 2023
------------	----------------------------	-----------------------

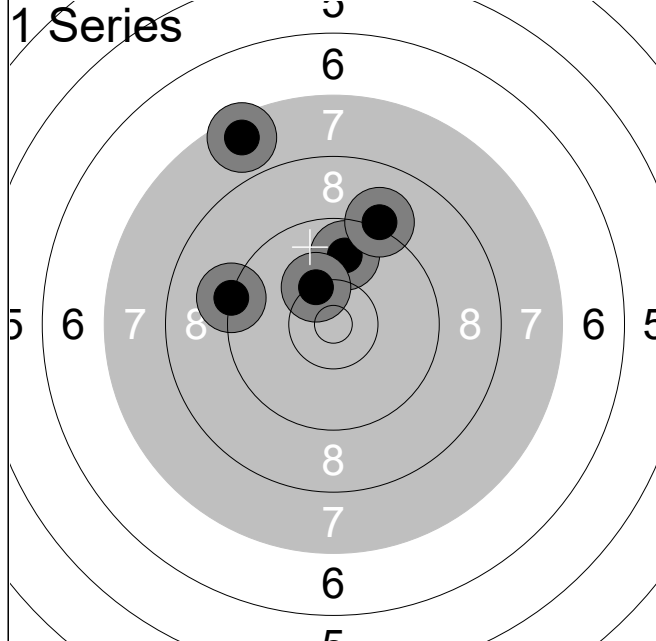

1:	7.6	↖
2:	9.8	↑
3:	9.1	↗
4:	10.3	↖
5:	9.2	←
Series		46.0
		46.0

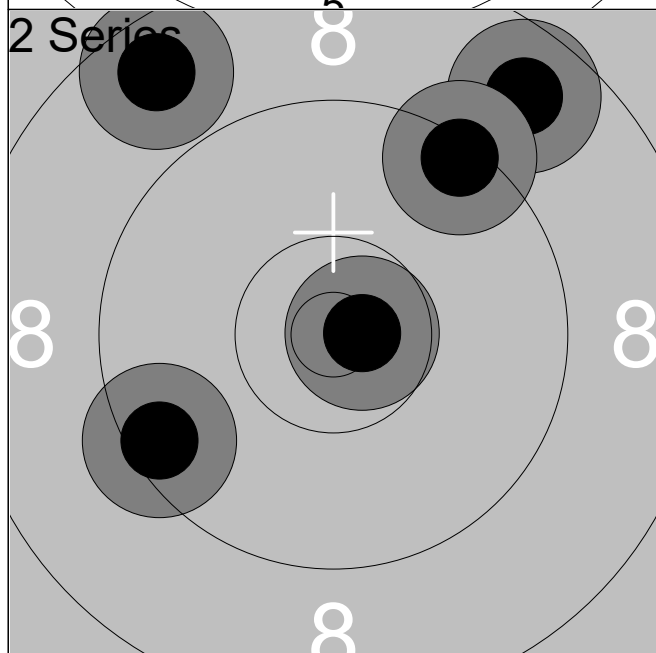

1:	8.6	↖
2:	8.7	↗
3:	9.4	↙
4:	10.7x	→
5:	9.4	↗
Series		46.8
		92.8

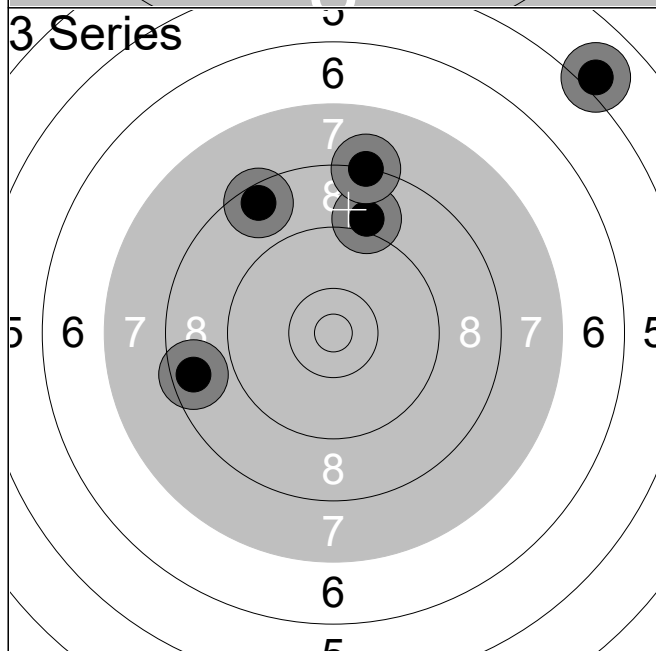

1:	8.5	↖
2:	5.0	↗
3:	9.0	↑
4:	8.2	↑
5:	8.6	←
Series		39.3
		132.1

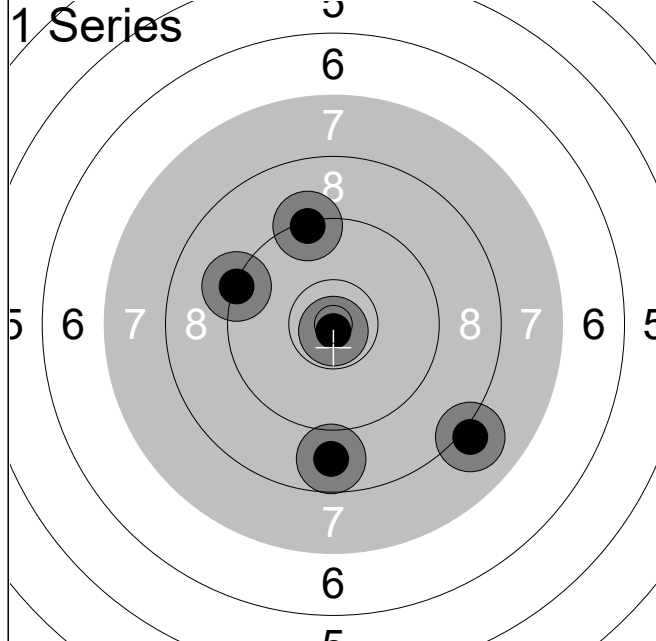

1:	9.3	↑
2:	8.1	↘
3:	10.8x	↓
4:	9.3	↙
5:	8.8	↓
Series		46.3
		46.3

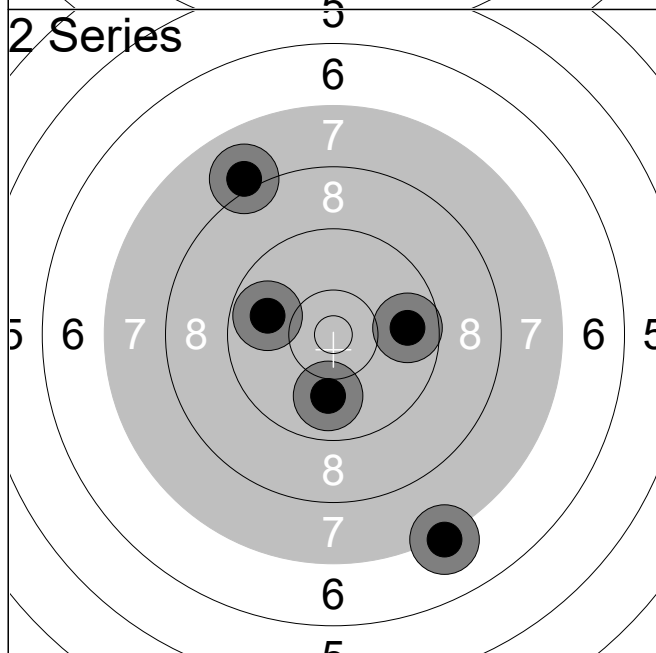

1:	8.0	↗
2:	9.8	↖
3:	7.2	↘
4:	9.7	→
5:	10.0	↓
Series		44.7
		91.0

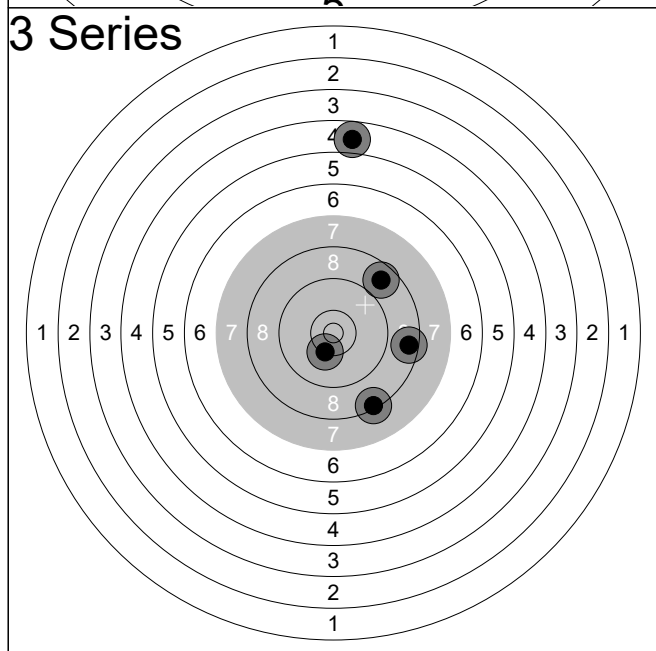

1:	8.5	→
2:	8.3	↘
3:	10.3	↘
4:	8.7	↗
5:	4.8	↑
Series		40.6
		131.6

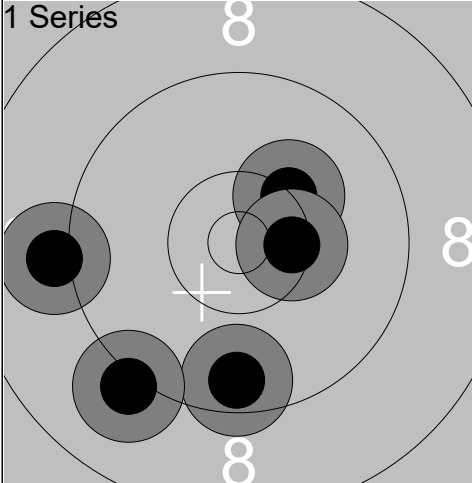
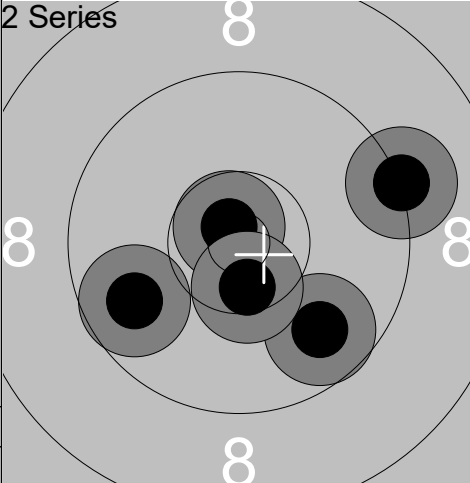
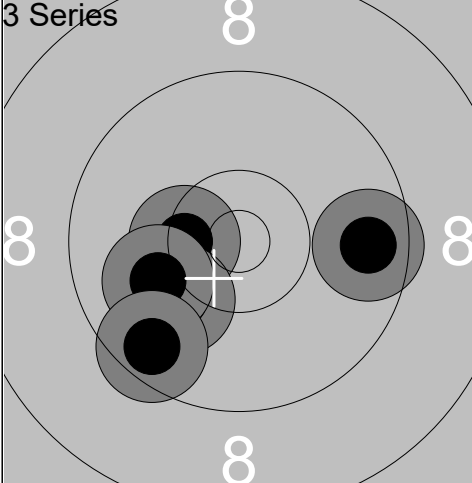
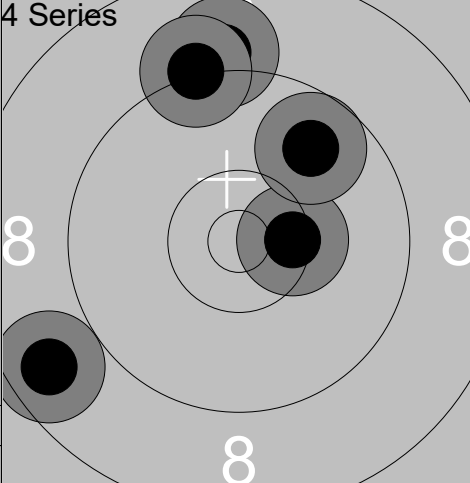
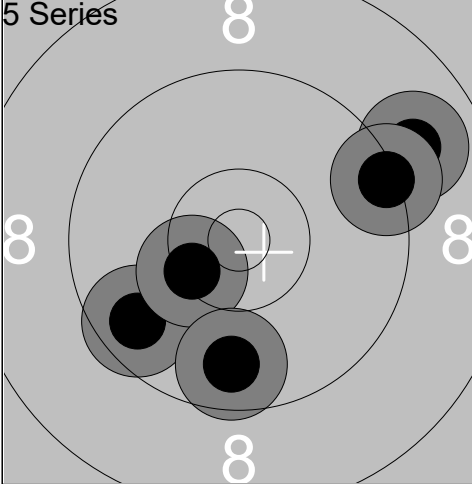
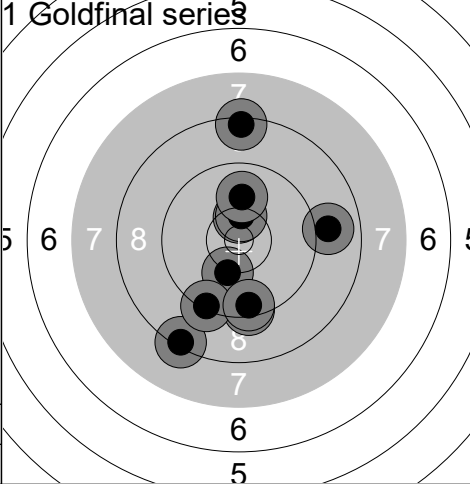
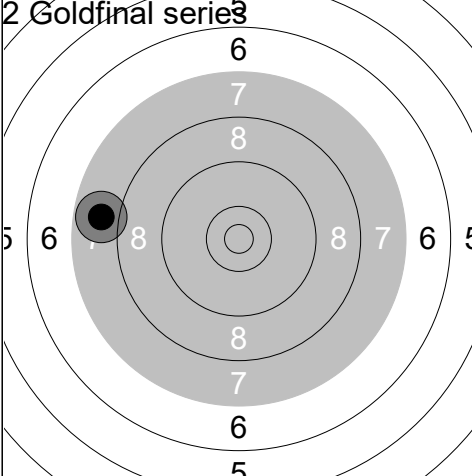
Relay 1	Lane 8	Jonas Kofoed Hansen			
3 Air Final Pistol Men		DEN		Mp	
19.02.2023		DENMARK OPEN AIR 2023 DAY3		Danmark Open Air 2023	
1 Series				1: 9.6 ↓ 2: 9.1 ← 3: 9.1 ↙ 4: 10.3 ↗ 5: 10.4x → Series 48.5 48.5	
2 Series				1: 9.2 → 2: 10.7x ↗ 3: 9.7 ↘ 4: 9.7 ← 5: 10.5x ↓ Series 49.8 98.3	
3 Series				1: 10.4x ← 2: 10.1 ↙ 3: 10.0 ← 4: 9.6 → 5: 9.6 ↙ Series 49.7 148.0	
4 Series				1: 9.0 ↑ 2: 10.4x → 3: 8.7 ↙ 4: 9.8 ↗ 5: 9.2 ↑ Series 47.1 195.1	
5 Series				1: 9.6 ↙ 2: 9.0 → 3: 10.4x ↙ 4: 9.7 ↓ 5: 9.3 → Series 48.0 243.1	
1 Goldfinal series				1: 8.9 → 2: 10.4x ↑ 3: 10.2 ↓ 4: 8.3 ↙ 5: 9.4 ↓ 6: 10.4x ↑ 7: 10.0 ↑ 8: 9.3 ↙ 9: 9.5 ↓ 10: 8.4 ↑ Series 94.8 337.9	
2 Goldfinal series				1: 7.8 ← Series 7.8 345.7	