

1:	9.2	↑
2:	10.0	→
3:	9.1	↑
4:	10.8x	↓
5:	9.1	←
6:	8.9	↗
7:	10.3	↖
8:	9.8	←
9:	9.7	↗
10:	8.4	↑
<b>Series</b>	<b>91 ( 1x)</b>	
	<b>91 ( 1x)</b>	

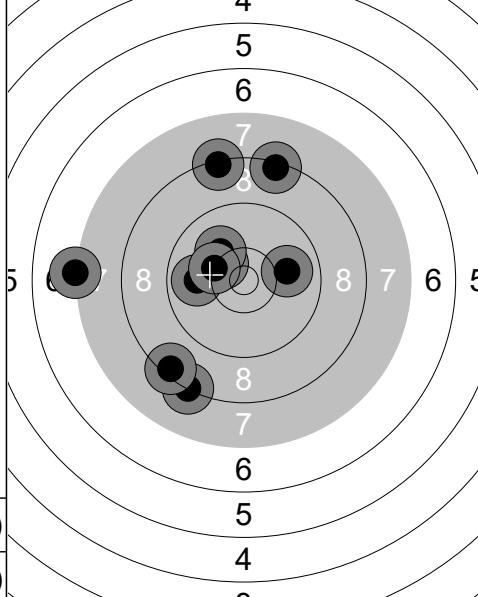

1:	10.0	→
2:	7.2	←
3:	9.9	←
4:	10.3	↖
5:	10.1	↖
6:	10.2	←
7:	8.3	↑
8:	8.2	↓
9:	8.4	↙
10:	8.3	↑
<b>Series</b>	<b>88 ( 0x)</b>	
	<b>179 ( 1x)</b>	

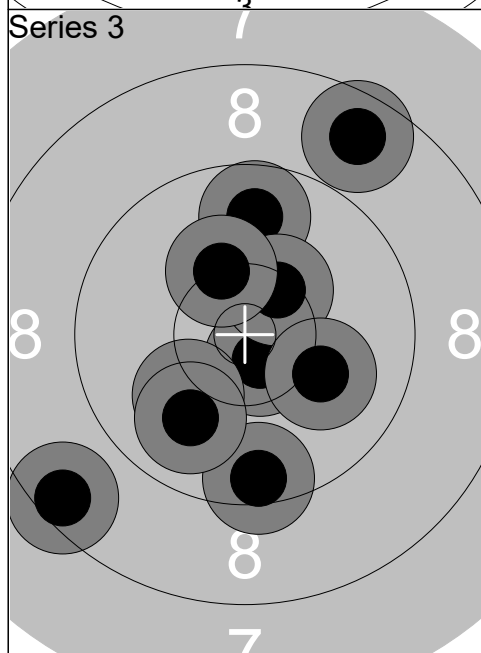

1:	8.5	←
2:	9.8	↑
3:	10.6x	↓
4:	9.5	↓
5:	8.6	↗
6:	10.4x	↗
7:	10.1	→
8:	10.1	←
9:	9.9	↓
10:	10.3	↑
<b>Series</b>	<b>93 ( 2x)</b>	
	<b>272 ( 3x)</b>	

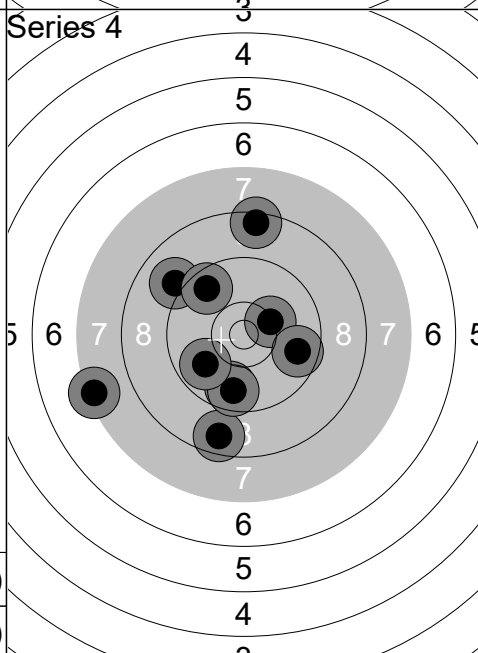

1:	10.3	↗
2:	9.7	↓
3:	8.4	↑
4:	8.6	↓
5:	7.4	←
6:	9.0	↖
7:	9.6	↗
8:	9.7	↓
9:	9.7	→
10:	9.9	↙
<b>Series</b>	<b>87 ( 0x)</b>	
	<b>359 ( 3x)</b>	

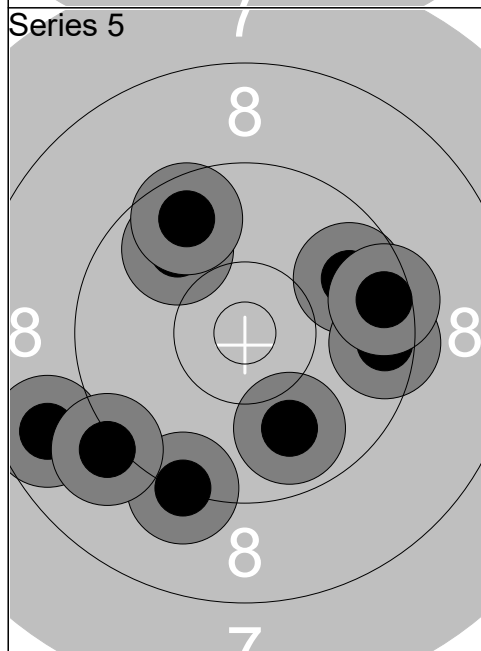

1:	9.6	→
2:	9.8	↗
3:	9.3	↓
4:	9.9	↖
5:	8.7	←
6:	9.5	→
7:	9.5	→
8:	9.9	↓
9:	9.7	↖
10:	9.1	↙
<b>Series</b>	<b>89 ( 0x)</b>	
	<b>448 ( 3x)</b>	

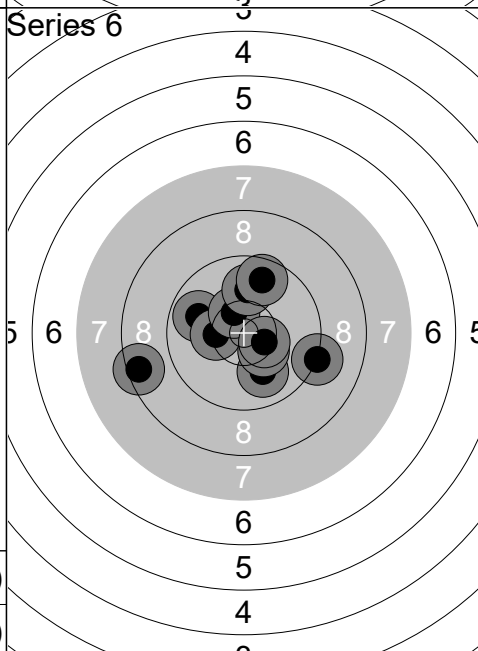

1:	9.9	←
2:	10.0	↓
3:	10.3	←
4:	10.4x	↖
5:	10.4	↙
6:	10.0	↑
7:	10.5x	↘
8:	9.2	→
9:	9.7	↑
10:	8.5	←
<b>Series</b>	<b>95 ( 2x)</b>	
	<b>543 ( 5x)</b>	

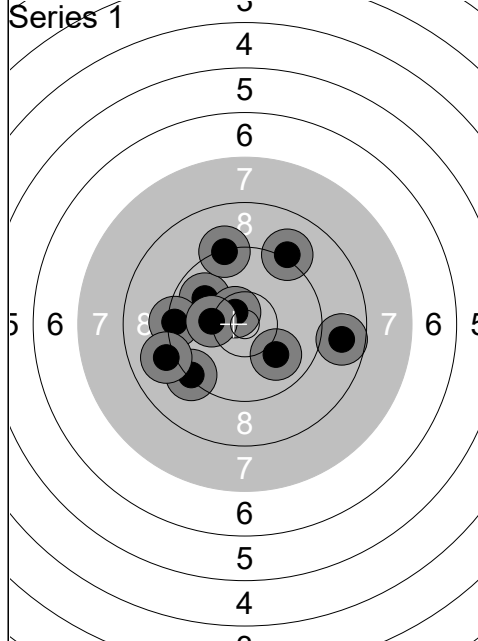

1: 8.8 →
2: 10.0 ↘
3: 9.9 ↗
4: 9.4 ←
5: 9.3 ↘
6: 9.0 ←
7: 10.6x ↗
8: 9.3 ↑
9: 10.2 ←
10: 9.1 ↗
<b>Series 92 ( 1x)</b>
<b>92 ( 1x)</b>

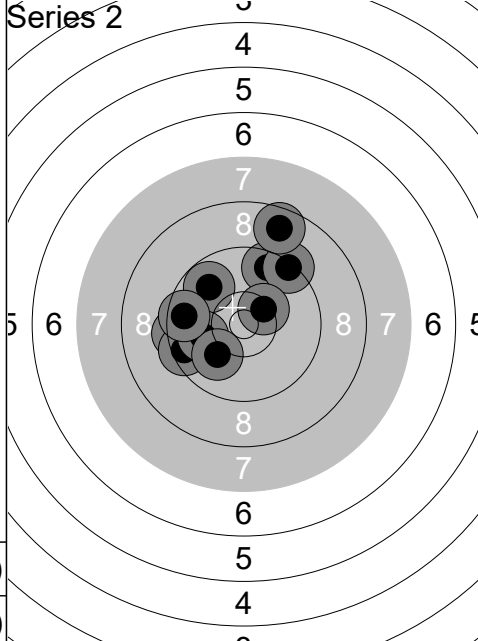

1: 9.6 ↗
2: 9.3 ↗
3: 9.4 ←
4: 10.4x ↗
5: 9.5 ←
6: 8.7 ↑
7: 9.8 ↗
8: 10.0 ←
9: 10.0 ↘
10: 9.6 ←
<b>Series 92 ( 1x)</b>
<b>184 ( 2x)</b>

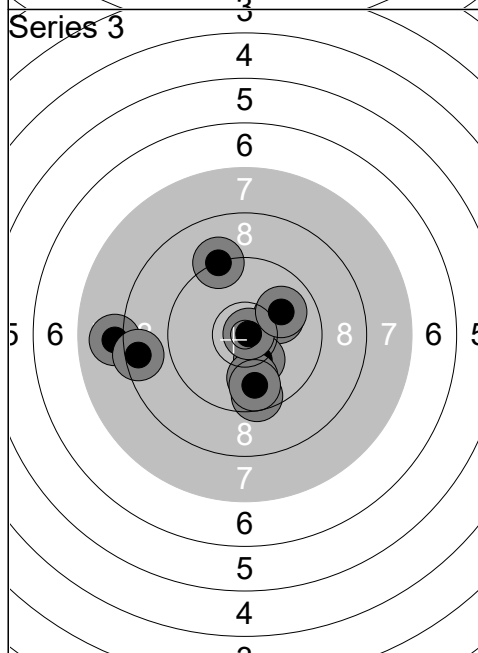

1: 10.1 ↗
2: 9.2 ↑
3: 10.3 ↘
4: 10.0 ↘
5: 8.0 ←
6: 8.5 ←
7: 9.6 ↘
8: 10.9x →
9: 10.0 ↗
10: 9.8 ↘
<b>Series 93 ( 1x)</b>
<b>277 ( 3x)</b>

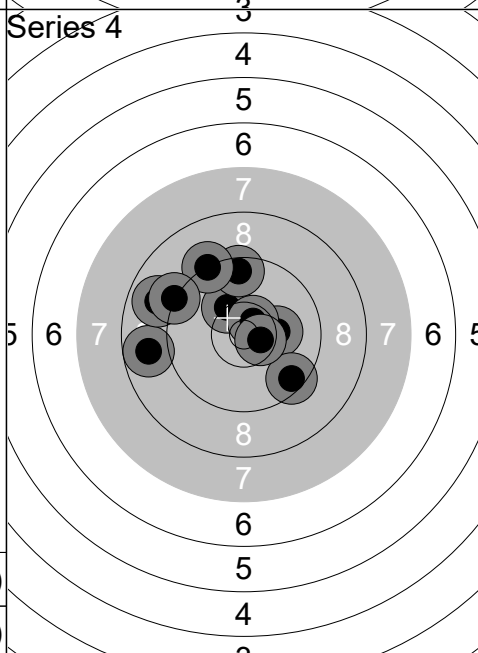

1: 10.2 →
2: 10.2 ↗
3: 9.5 ↑
4: 8.8 ←
5: 9.5 ↘
6: 9.2 ↑
7: 10.6x ↗
8: 10.5x →
9: 8.9 ←
10: 9.2 ↗
<b>Series 92 ( 2x)</b>
<b>369 ( 5x)</b>

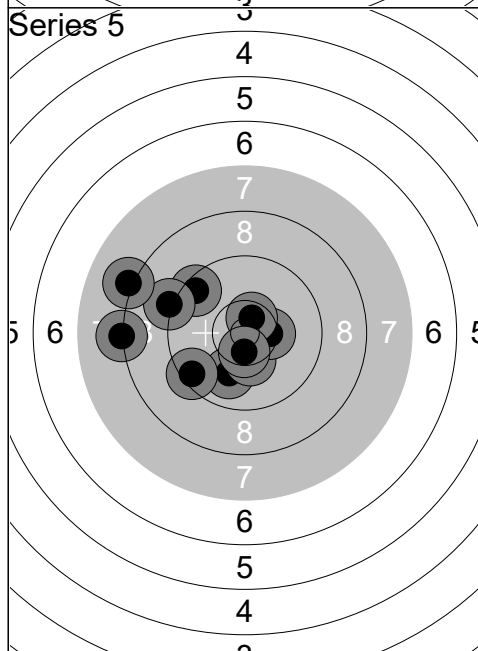

1: 10.0 ↘
2: 10.3 ↘
3: 9.5 ↘
4: 10.4x →
5: 10.6x ↗
6: 9.5 ↗
7: 8.2 ←
8: 9.1 ←
9: 8.1 ←
10: 10.5x ↘
<b>Series 93 ( 3x)</b>
<b>462 ( 8x)</b>

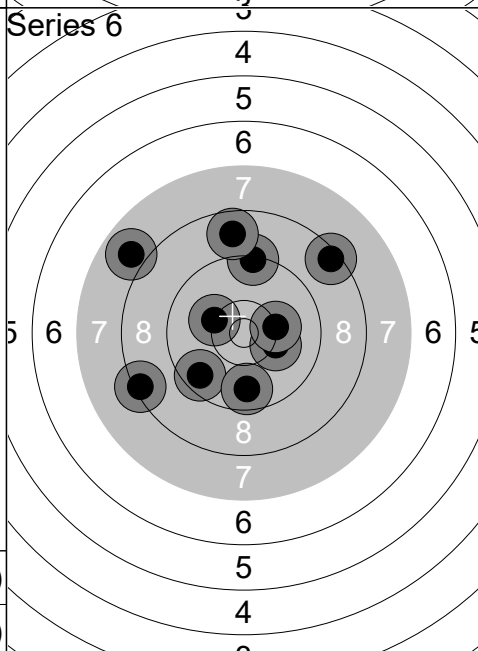

1: 10.2 →
2: 9.6 ↘
3: 9.7 ↘
4: 9.3 ↑
5: 8.3 ←
6: 7.9 ↗
7: 8.7 ↑
8: 10.2 ↗
9: 10.2 →
10: 8.4 ↗
<b>Series 88 ( 0x)</b>
<b>550 ( 8x)</b>

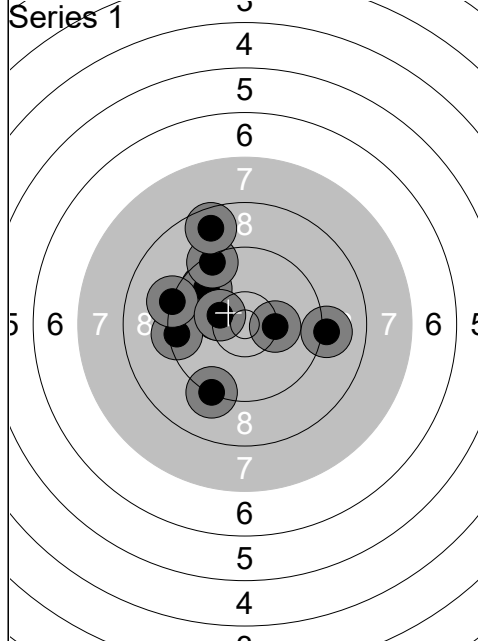

1: 10.3 ←
2: 9.8 ↖
3: 9.2 ↓
4: 9.1 →
5: 9.4 ←
6: 10.3 →
7: 9.4 ↗
8: 8.7 ↗
9: 9.2 ←
10: 10.4x ←
<b>Series 92 ( 1x)</b>
<b>92 ( 1x)</b>

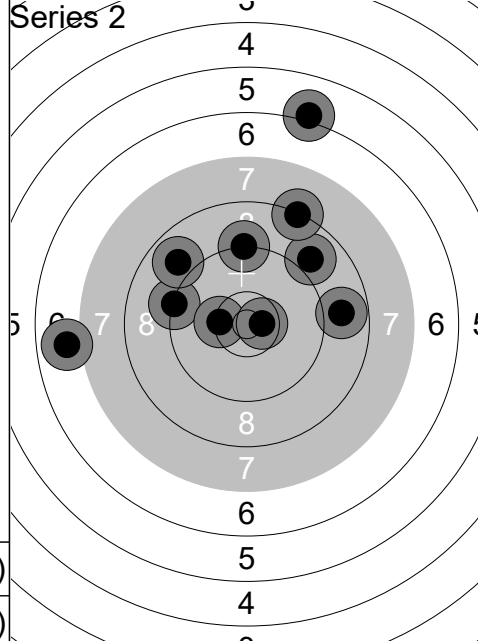

1: 8.8 →
2: 9.3 ←
3: 8.9 ↗
4: 9.2 ↑
5: 6.9 ←
6: 10.3 ←
7: 6.1 ↑
8: 8.9 ↖
9: 10.6x →
10: 8.3 ↗
<b>Series 82 ( 1x)</b>
<b>174 ( 2x)</b>

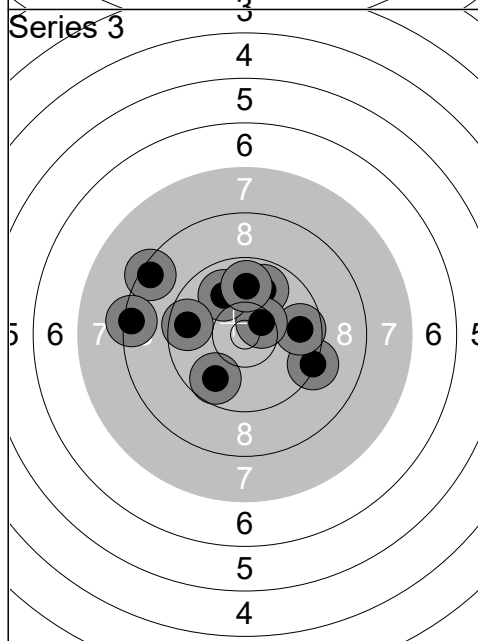

1: 9.8 ↓
2: 9.3 →
3: 9.9 ↑
4: 9.7 →
5: 10.5x ↗
6: 9.9 ↗
7: 8.5 ↖
8: 9.9 ↑
9: 9.7 ←
10: 8.4 ←
<b>Series 89 ( 1x)</b>
<b>263 ( 3x)</b>

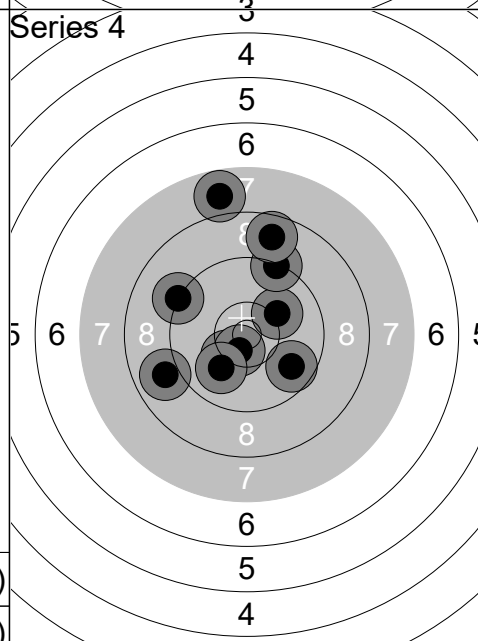

1: 10.1 ↗
2: 8.9 ←
3: 10.3 ↓
4: 9.3 ↗
5: 9.7 →
6: 7.8 ↑
7: 10.6x ↓
8: 10.0 ↓
9: 8.7 ↑
10: 9.2 ↖
<b>Series 90 ( 1x)</b>
<b>353 ( 4x)</b>

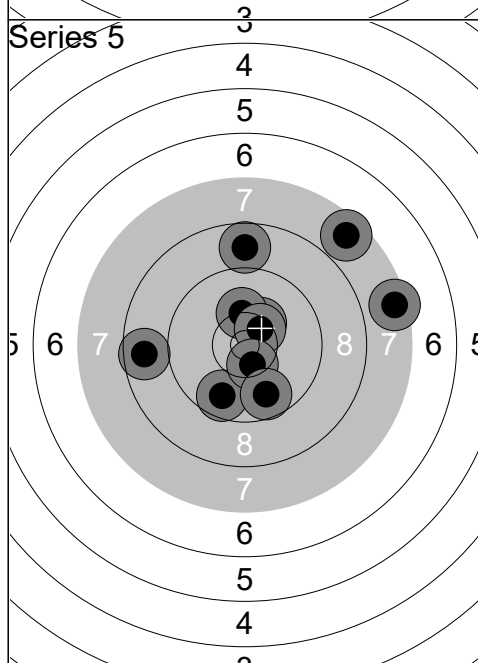

1: 7.5 →
2: 10.3 ↗
3: 9.7 ↓
4: 8.7 ←
5: 10.2 ↑
6: 7.6 ↗
7: 10.5x ↗
8: 8.8 ↑
9: 10.5x ↓
10: 9.7 ↓
<b>Series 88 ( 2x)</b>
<b>441 ( 6x)</b>

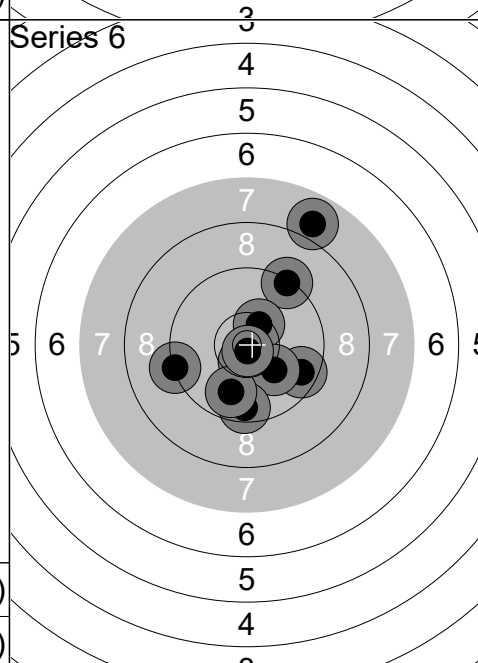

1: 10.6x ↓
2: 9.3 ←
3: 7.9 ↗
4: 9.3 ↗
5: 9.6 →
6: 10.4x ↗
7: 10.1 →
8: 9.5 ↓
9: 9.9 ↓
10: 10.8x ↓
<b>Series 92 ( 3x)</b>
<b>533 ( 9x)</b>

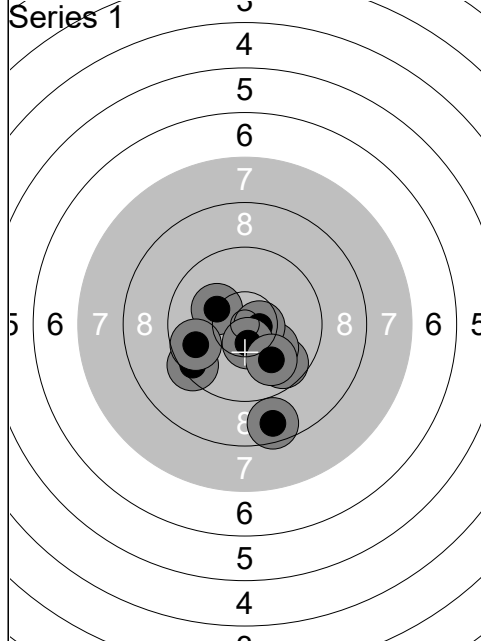

1: 9.7 ↘
2: 10.5x ↘
3: 10.1 ↘
4: 8.7 ↘
5: 9.5 ↙
6: 10.2 ↖
7: 10.6x →
8: 9.8 ←
9: 10.5x ↘
10: 9.9 ↘
<b>Series 94 ( 3x)</b>
<b>94 ( 3x)</b>

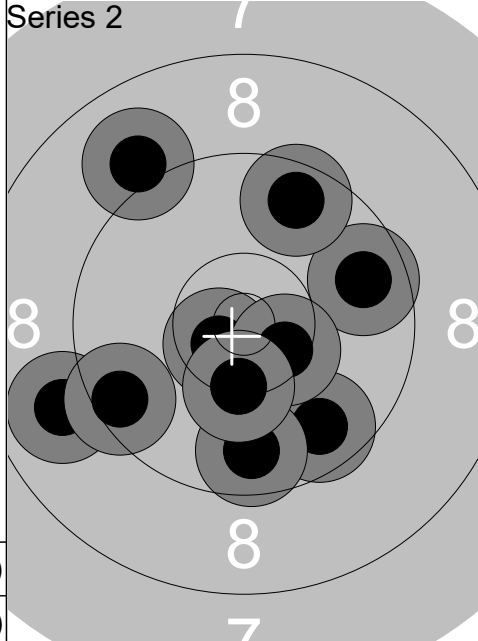

1: 9.7 →
2: 9.7 ↘
3: 8.9 ←
4: 9.0 ↗
5: 9.5 ↙
6: 9.7 ↓
7: 9.6 ↗
8: 10.6x ↙
9: 10.5x ↘
10: 10.3 ↓
<b>Series 92 ( 2x)</b>
<b>186 ( 5x)</b>

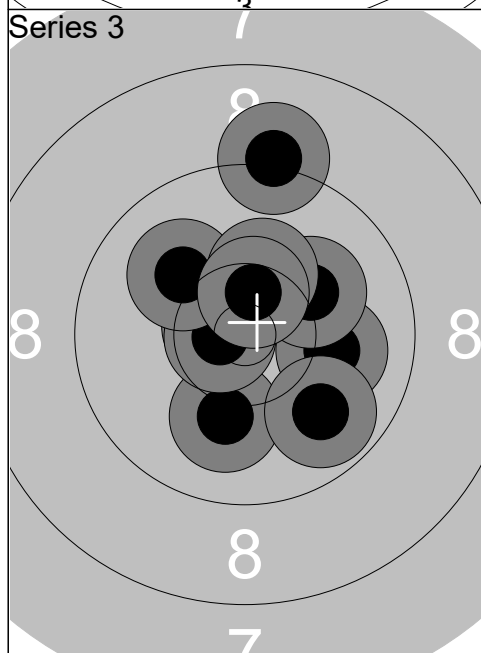

1: 10.6x ↙
2: 10.1 →
3: 10.1 ↓
4: 10.2 ↗
5: 10.7x ↙
6: 10.1 ↖
7: 10.3 ↗
8: 9.2 ↗
9: 9.9 ↘
10: 10.5x ↗
<b>Series 98 ( 3x)</b>
<b>284 ( 8x)</b>

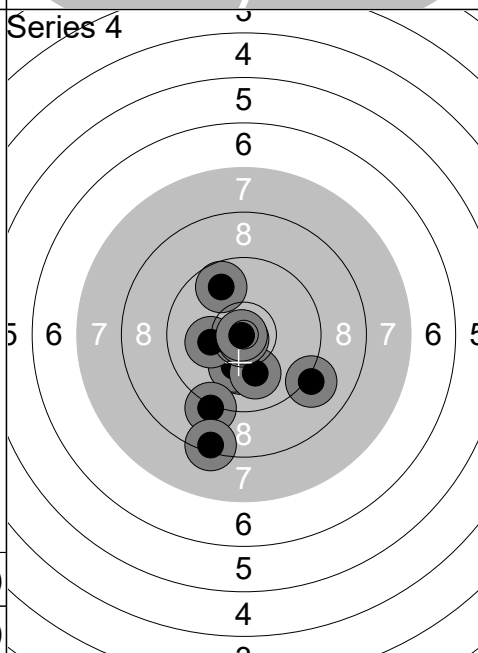

1: 10.2 ↓
2: 10.2 ↓
3: 9.1 ↘
4: 10.2 ←
5: 10.1 ↓
6: 9.1 ↓
7: 9.8 ↗
8: 8.4 ↓
9: 10.8x ↘
10: 10.9x ↙
<b>Series 95 ( 2x)</b>
<b>379 (10x)</b>

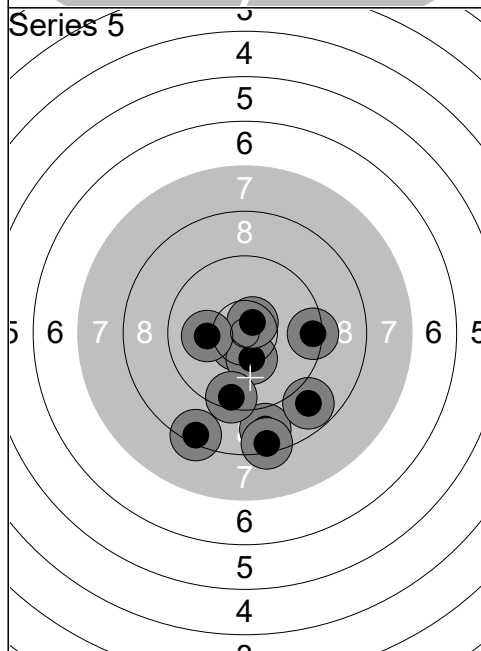

1: 10.6x ↘
2: 8.8 ↓
3: 9.4 →
4: 8.4 ↘
5: 10.3 ↓
6: 10.6x ↗
7: 10.1 ←
8: 9.5 ↓
9: 8.4 ↓
10: 8.8 ↘
<b>Series 90 ( 2x)</b>
<b>469 (12x)</b>

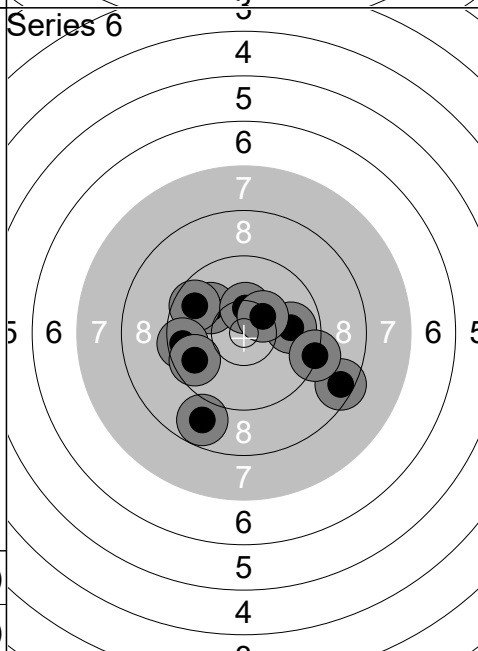

1: 10.0 ↖
2: 9.7 ↖
3: 9.6 ←
4: 10.4x ↗
5: 8.5 ↘
6: 9.9 →
7: 9.3 →
8: 9.7 ←
9: 10.4x ↗
10: 8.8 ↓
<b>Series 91 ( 2x)</b>
<b>560 (14x)</b>

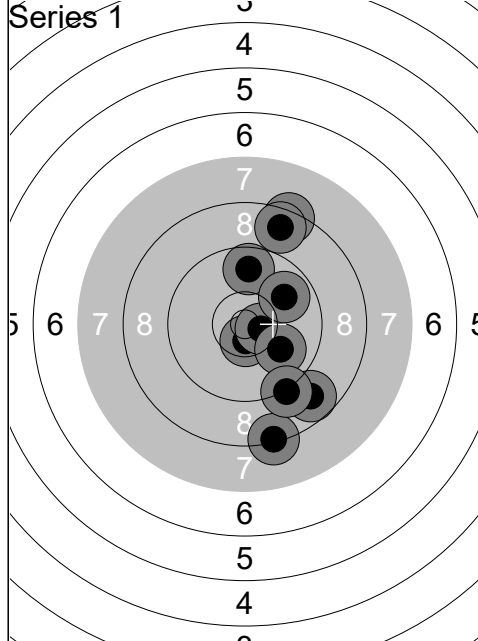

1:	10.6x ↓
2:	8.8 ↘
3:	10.6x →
4:	9.7 ↑
5:	8.4 ↗
6:	8.3 ↓
7:	9.9 ↗
8:	8.6 ↑
9:	10.0 ↓
10:	9.2 ↓
<b>Series</b>	<b>89 ( 2x)</b>
	<b>89 ( 2x)</b>

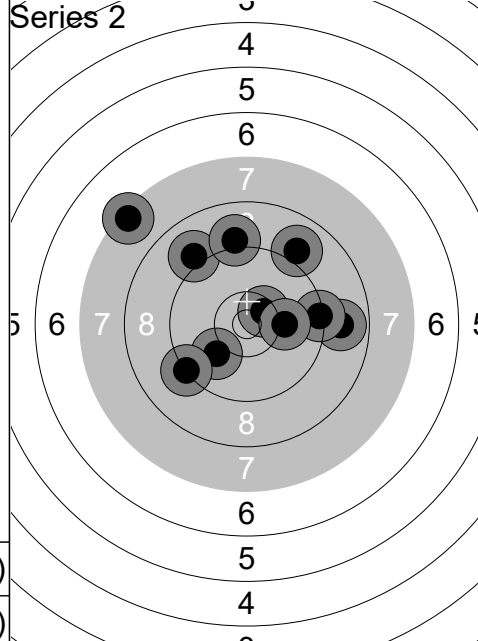

1:	10.0 ↙
2:	8.9 →
3:	7.4 ↖
4:	10.5x ↗
5:	9.3 ↙
6:	9.3 →
7:	10.1 →
8:	9.0 ↖
9:	9.0 ↗
10:	9.1 ↑
<b>Series</b>	<b>90 ( 1x)</b>
	<b>179 ( 3x)</b>

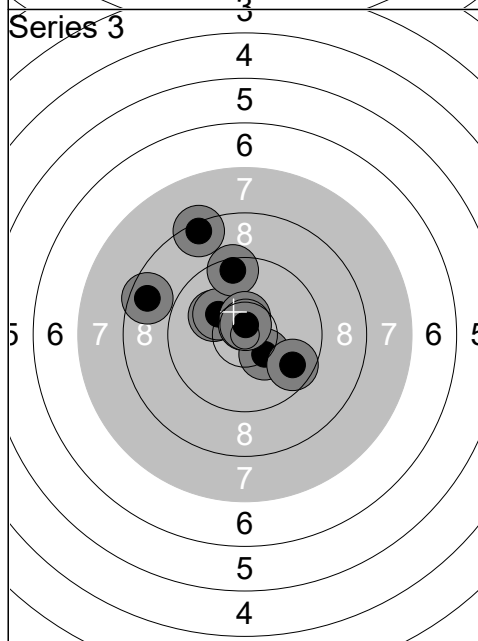

1:	10.1 ↖
2:	10.2 ↖
3:	10.7x ↑
4:	9.5 ↑
5:	10.3 ↓
6:	10.6x ↑
7:	8.4 ↗
8:	9.7 ↘
9:	8.6 ↖
10:	10.7x ↑
<b>Series</b>	<b>94 ( 3x)</b>
	<b>273 ( 6x)</b>

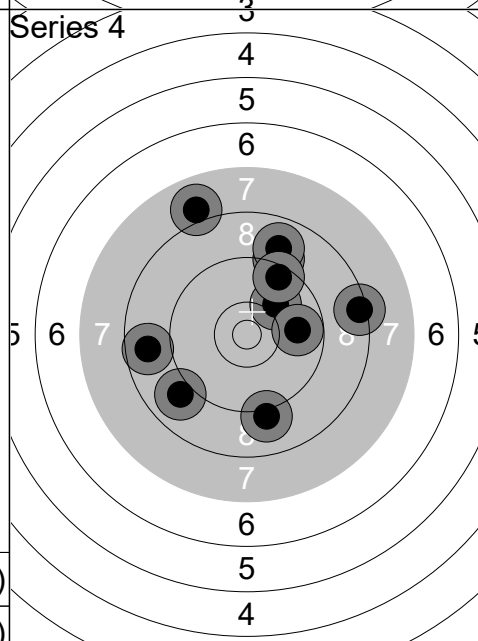

1:	9.1 ↑
2:	8.0 ↑
3:	9.1 ↓
4:	10.0 ↗
5:	8.9 ↑
6:	8.4 →
7:	9.0 ↙
8:	9.5 ↗
9:	8.7 ←
10:	9.8 →
<b>Series</b>	<b>87 ( 0x)</b>
	<b>360 ( 6x)</b>

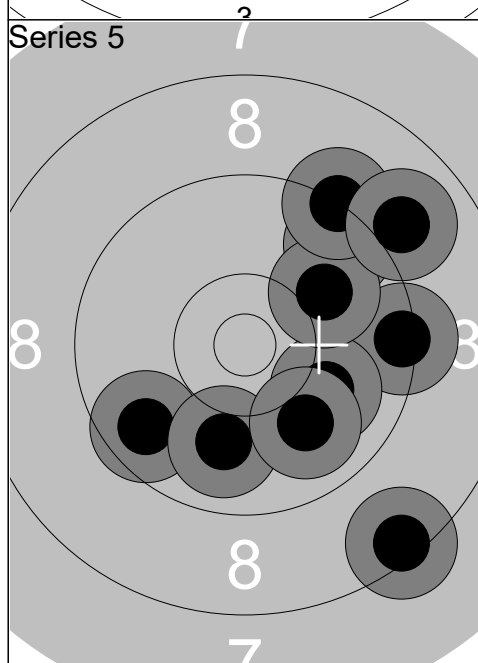

1:	9.6 ↗
2:	9.6 ↙
3:	8.4 ↓
4:	9.4 →
5:	10.0 ↓
6:	9.9 ↓
7:	10.0 ↗
8:	9.9 ↓
9:	9.2 ↗
10:	9.0 ↗
<b>Series</b>	<b>91 ( 0x)</b>
	<b>451 ( 6x)</b>

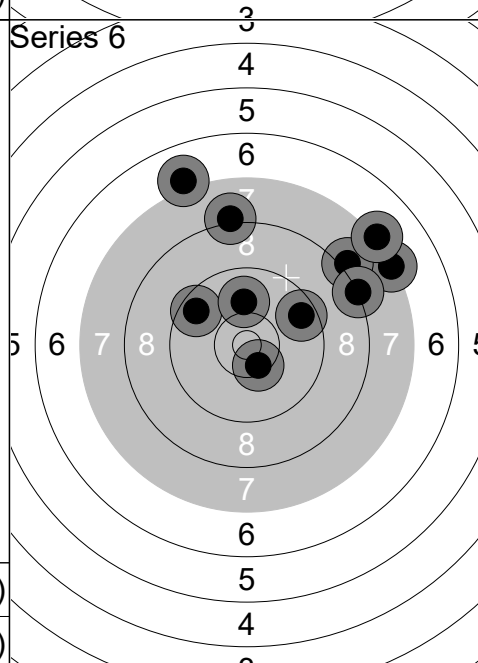

1:	7.0 ↑
2:	9.6 ↖
3:	7.3 ↗
4:	9.6 ↗
5:	10.4x ↓
6:	8.1 ↗
7:	8.2 ↗
8:	7.2 ↗
9:	8.1 ↑
10:	10.0 ↑
<b>Series</b>	<b>83 ( 1x)</b>
	<b>534 ( 7x)</b>

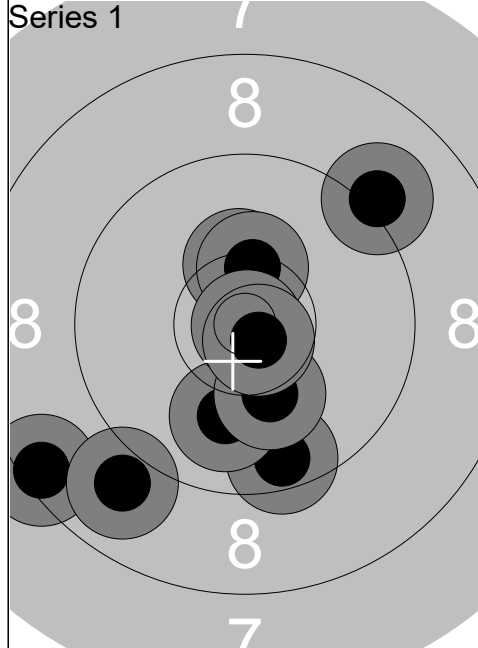

1: 10.3 ↑
2: 8.4 ↙
3: 10.4x ↑
4: 9.5 ↓
5: 10.0 ↓
6: 9.1 ↗
7: 10.9x ➤
8: 10.2 ↓
9: 8.9 ↙
10: 10.7x ↘
<b>Series 94 ( 3x)</b>
<b>94 ( 3x)</b>

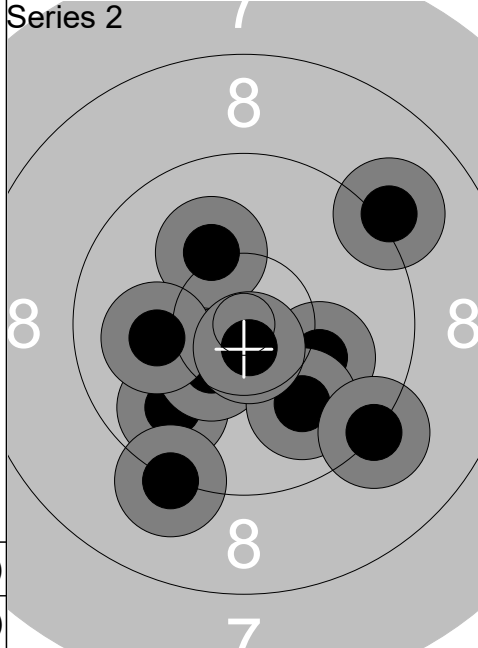

1: 10.1 ↖
2: 9.8 ↙
3: 9.2 ↓
4: 10.4x ↙
5: 9.1 ↗
6: 10.1 ←
7: 10.1 ➤
8: 9.9 ↓
9: 10.7x ↓
10: 9.2 ↘
<b>Series 95 ( 2x)</b>
<b>189 ( 5x)</b>

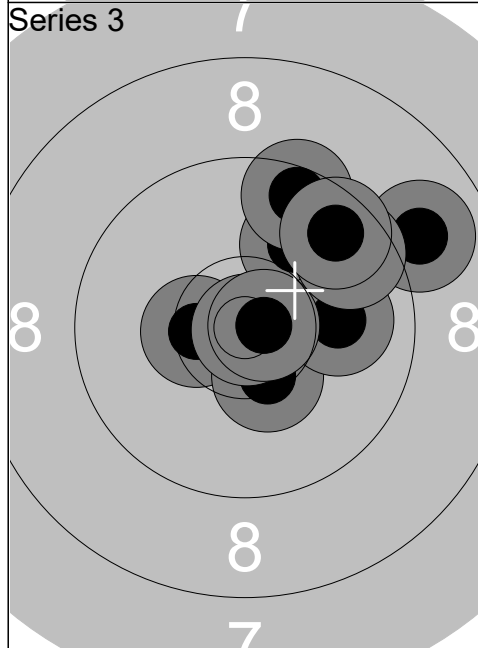

1: 10.5x ←
2: 10.4x ↓
3: 10.0 ↗
4: 9.0 ↗
5: 10.0 ➔
6: 9.6 ↗
7: 9.5 ↑
8: 10.9x ↘
9: 10.8x ➔
10: 9.6 ↗
<b>Series 96 ( 4x)</b>
<b>285 ( 9x)</b>

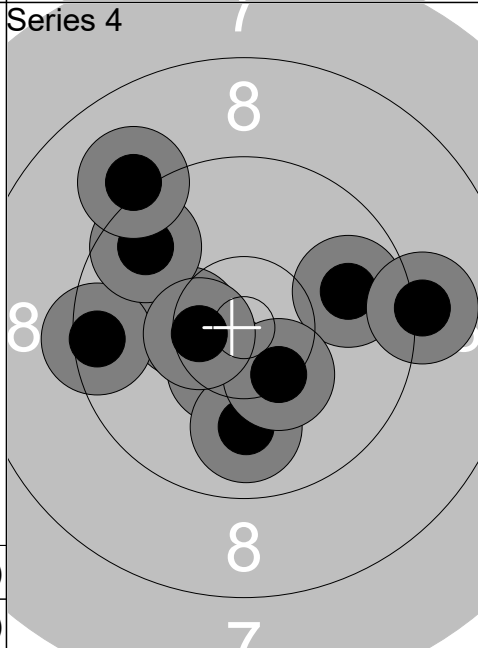

1: 9.8 ➔
2: 10.5x ↓
3: 10.3 ←
4: 9.1 ➔
5: 9.5 ←
6: 9.9 ↓
7: 10.3 ↘
8: 9.7 ↖
9: 10.5x ←
10: 9.1 ↖
<b>Series 94 ( 2x)</b>
<b>379 (11x)</b>

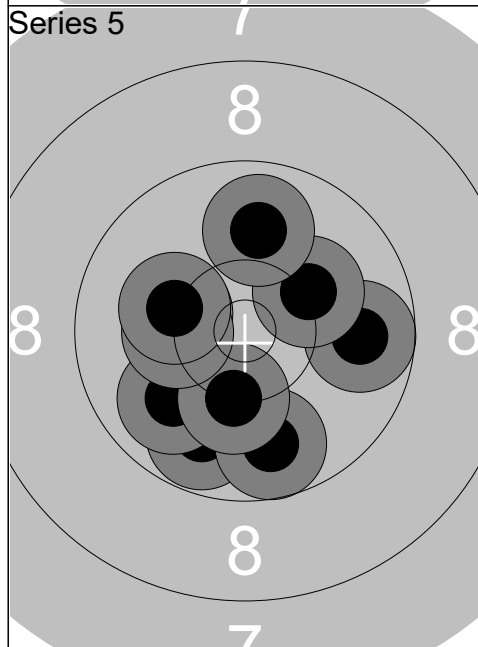

1: 9.8 ➔
2: 9.8 ↓
3: 10.2 ←
4: 10.2 ↗
5: 9.8 ↓
6: 10.0 ↙
7: 9.9 ↑
8: 10.3 ↓
9: 10.3 ←
10: 10.2 ←
<b>Series 96 ( 0x)</b>
<b>475 (11x)</b>

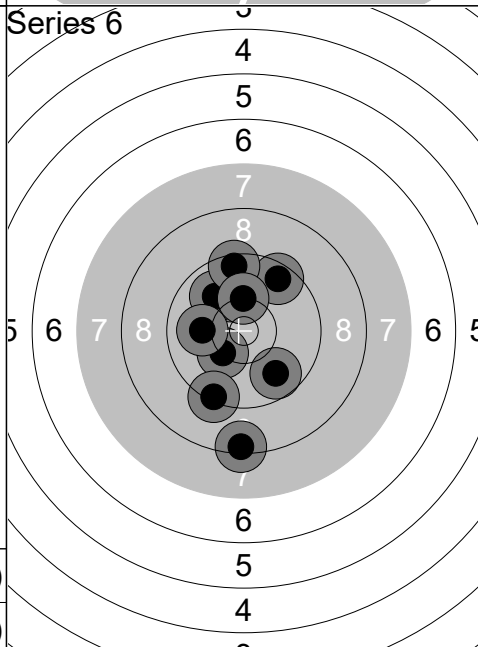

1: 9.6 ↗
2: 10.3 ↙
3: 10.1 ↑
4: 9.8 ↘
5: 9.9 ↗
6: 10.0 ←
7: 9.3 ↓
8: 8.4 ↓
9: 9.5 ↑
10: 10.2 ↑
<b>Series 93 ( 0x)</b>
<b>568 (11x)</b>

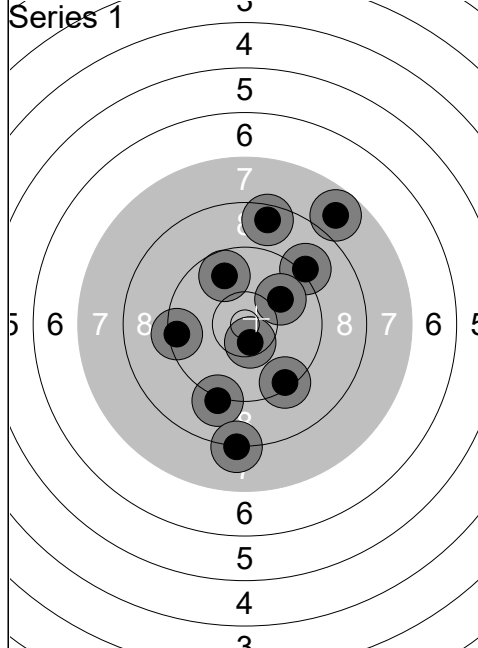

1:	7.8	↗
2:	10.5x	↘
3:	9.8	↖
4:	8.6	↗
5:	9.1	↘
6:	9.4	←
7:	8.2	↘
8:	9.1	↗
9:	9.4	↘
10:	10.0	↗
<b>Series</b>	<b>88 ( 1x)</b>	
	<b>88 ( 1x)</b>	

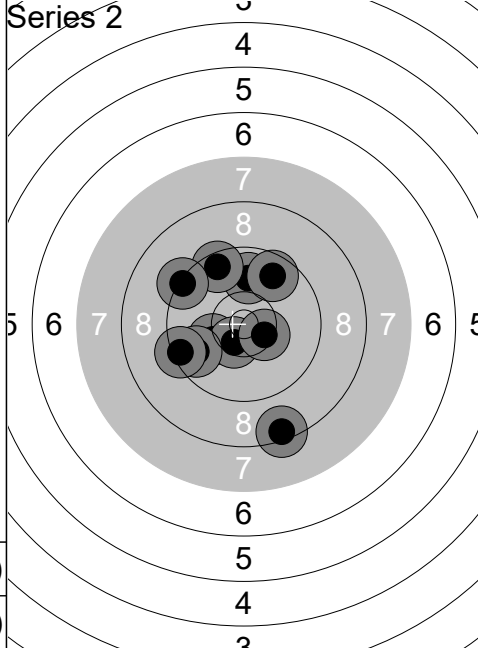

1:	10.2	↙
2:	10.5x	↘
3:	10.4x	↘
4:	9.9	↗
5:	9.7	↙
6:	9.7	↗
7:	9.4	↙
8:	9.5	↗
9:	8.4	↘
10:	9.3	↙
<b>Series</b>	<b>92 ( 2x)</b>	
	<b>180 ( 3x)</b>	

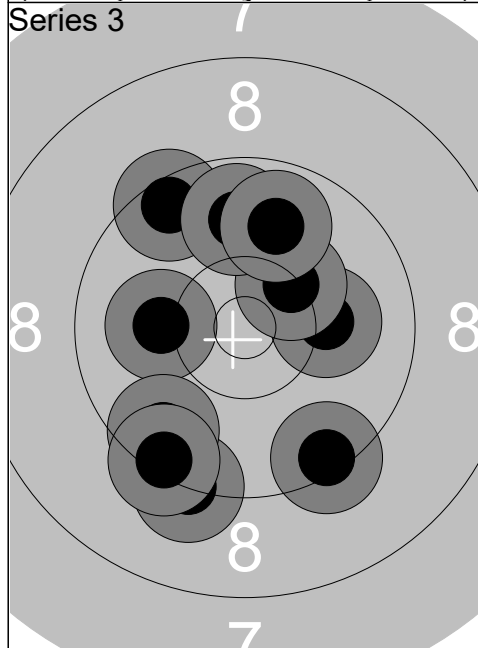

1:	10.1	→
2:	10.3	↗
3:	9.5	↖
4:	9.9	↗
5:	9.2	↘
6:	10.1	←
7:	9.9	↗
8:	9.6	↘
9:	9.4	↘
10:	9.4	↘
<b>Series</b>	<b>93 ( 0x)</b>	
	<b>273 ( 3x)</b>	

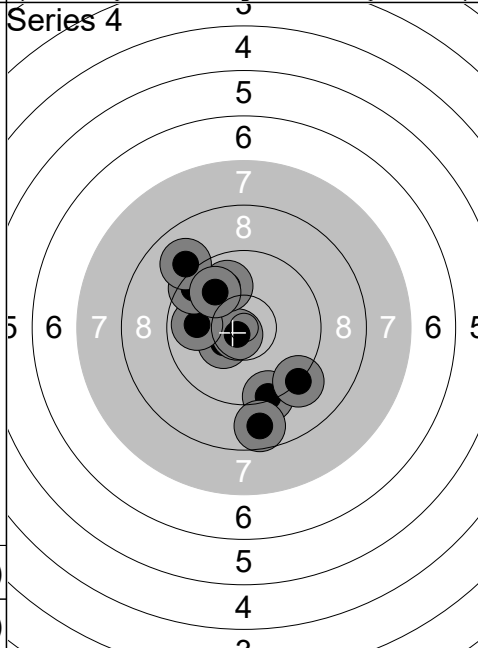

1:	10.4x	↙
2:	10.7x	↙
3:	9.9	←
4:	9.5	↗
5:	9.3	↘
6:	9.9	↗
7:	9.0	↗
8:	9.2	↘
9:	9.9	↗
10:	8.7	↘
<b>Series</b>	<b>91 ( 2x)</b>	
	<b>364 ( 5x)</b>	

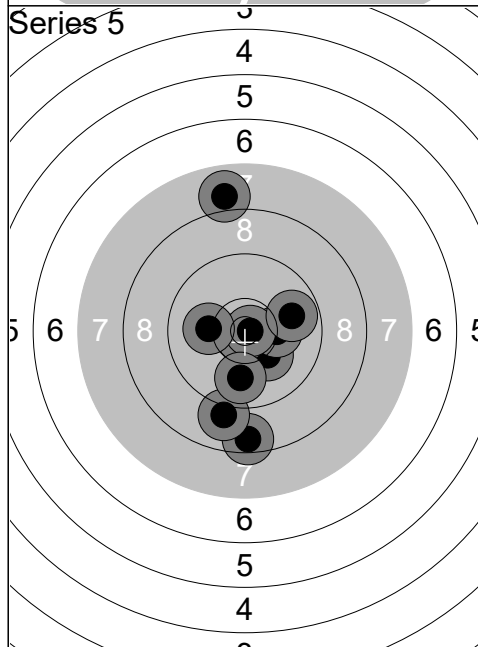

1:	10.2	↘
2:	7.9	↗
3:	10.8x	↘
4:	8.5	↘
5:	10.2	→
6:	9.0	↘
7:	10.8x	→
8:	10.1	←
9:	9.8	→
10:	9.9	↘
<b>Series</b>	<b>92 ( 2x)</b>	
	<b>456 ( 7x)</b>	

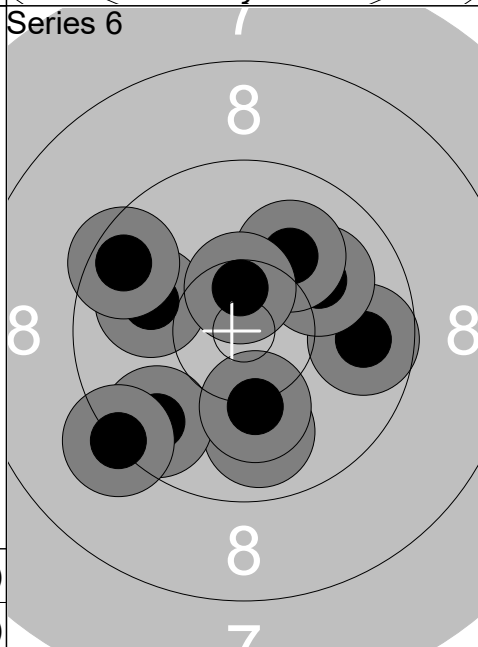

1:	9.9	↘
2:	9.7	→
3:	10.0	↗
4:	10.0	←
5:	10.1	↗
6:	9.7	↙
7:	9.3	↙
8:	10.5x	↗
9:	9.5	↙
10:	10.2	↘
<b>Series</b>	<b>95 ( 1x)</b>	
	<b>551 ( 8x)</b>	

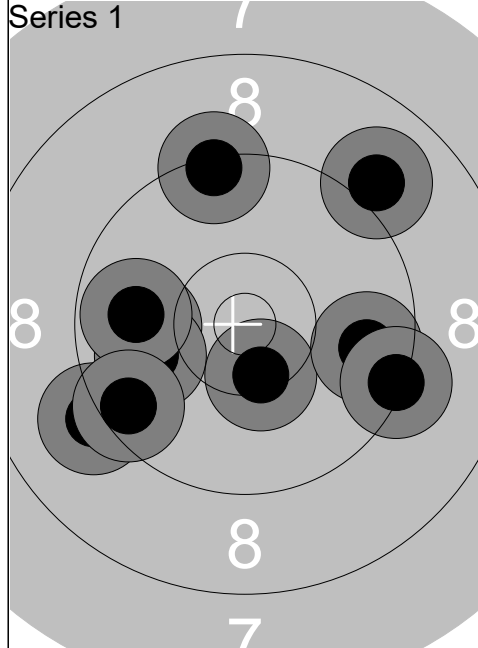

1: 9.1 ↙
2: 9.9 ←
3: 9.9 ←
4: 9.8 ←
5: 9.3 ↑
6: 9.5 ↙
7: 10.4x ↓
8: 9.7 →
9: 9.3 →
10: 9.0 ↗
<b>Series 91 ( 1x)</b>
<b>91 ( 1x)</b>

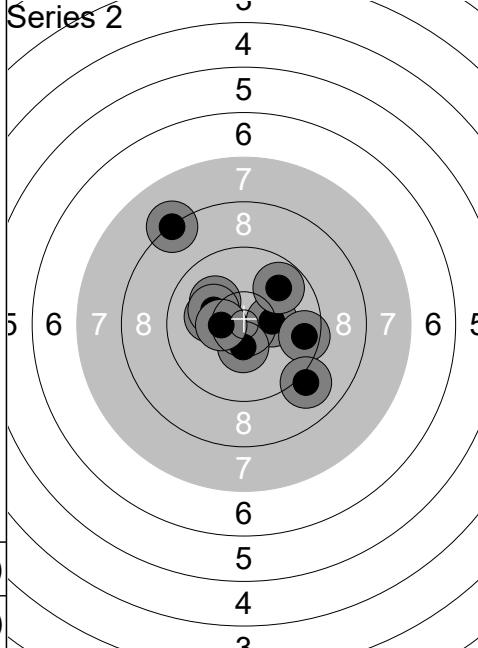

1: 10.1 ↗
2: 10.2 ←
3: 10.3 →
4: 10.2 ↙
5: 9.6 →
6: 10.4x ↓
7: 10.4x ←
8: 9.0 ↘
9: 8.3 ↗
10: 9.8 ↗
<b>Series 95 ( 2x)</b>
<b>186 ( 3x)</b>

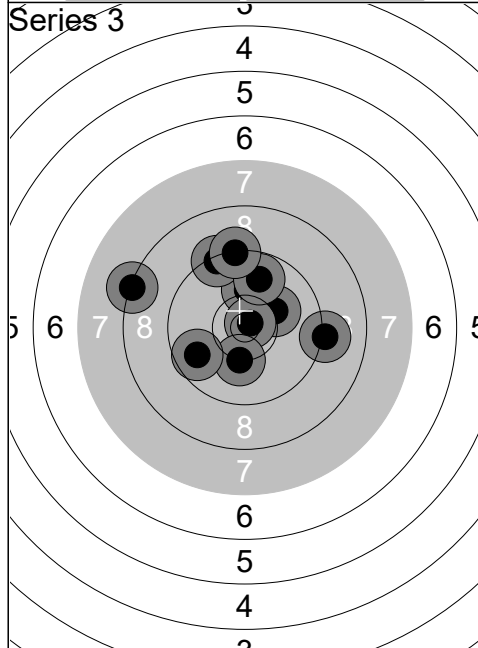

1: 10.1 ↑
2: 8.3 ←
3: 10.2 ↗
4: 9.1 →
5: 10.8x ↗
6: 9.3 ↑
7: 9.8 ↑
8: 10.2 ↓
9: 9.3 ↑
10: 9.7 ↙
<b>Series 93 ( 1x)</b>
<b>279 ( 4x)</b>

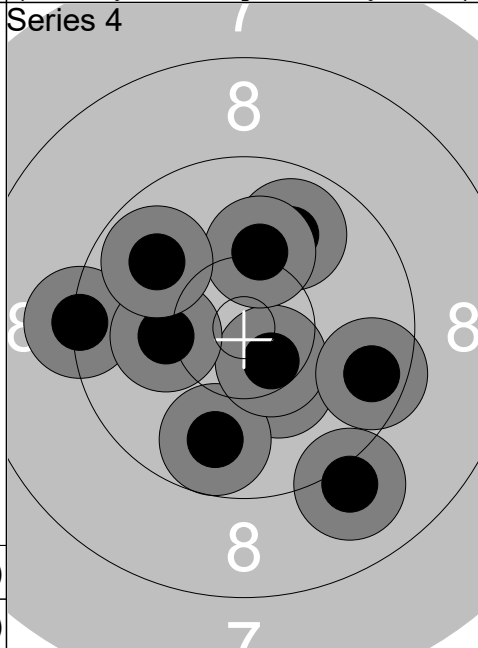

1: 10.3 ↘
2: 9.3 ←
3: 9.9 ↗
4: 9.8 ↓
5: 10.5x ↘
6: 9.0 ↘
7: 10.2 ←
8: 10.2 ↑
9: 9.6 →
10: 9.8 ↗
<b>Series 94 ( 1x)</b>
<b>373 ( 5x)</b>

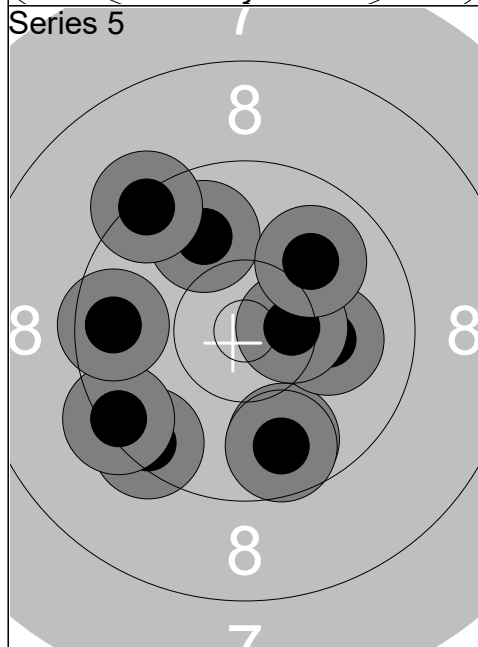

1: 9.4 ↙
2: 9.9 ↗
3: 9.8 ↓
4: 10.1 →
5: 9.4 ↙
6: 10.5x →
7: 10.0 ↗
8: 9.6 ←
9: 9.7 ↓
10: 9.3 ↗
<b>Series 93 ( 1x)</b>
<b>466 ( 6x)</b>

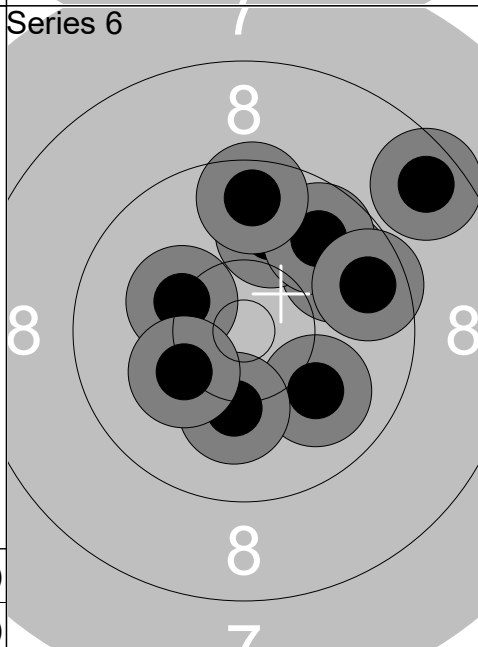

1: 10.2 ←
2: 9.8 ↗
3: 9.9 ↗
4: 10.0 ↘
5: 10.2 ↓
6: 9.8 ↗
7: 9.6 →
8: 10.2 ↙
9: 9.6 ↑
10: 8.6 ↗
<b>Series 93 ( 0x)</b>
<b>559 ( 6x)</b>



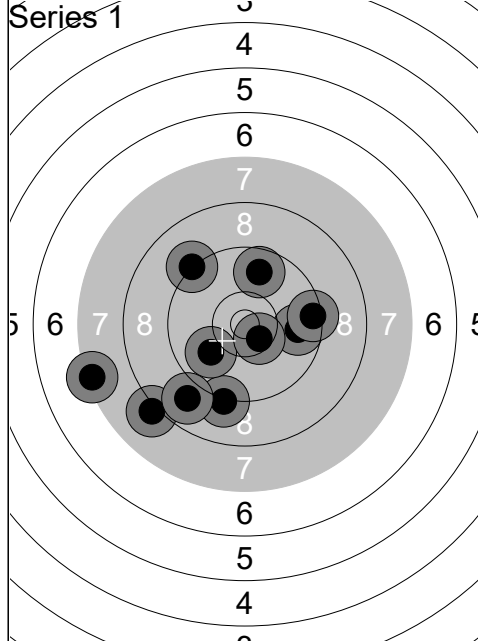

1: 9.2 ↓
2: 8.1 ↙
3: 9.8 →
4: 9.7 ↑
5: 10.0 ↙
6: 10.5x ↘
7: 8.9 ↙
8: 9.4 →
9: 7.3 ↙
10: 9.2 ↙
<b>Series 88 ( 1x)</b>
<b>88 ( 1x)</b>

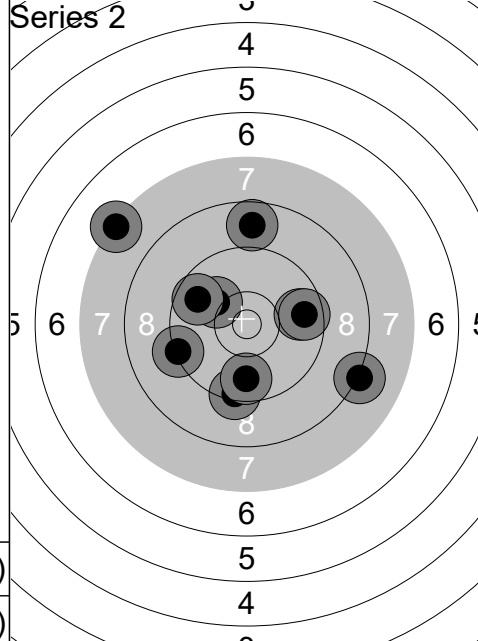

1: 9.4 ↓
2: 10.1 ↖
3: 9.7 ↓
4: 9.7 →
5: 9.7 →
6: 8.7 ↑
7: 9.3 ↙
8: 8.2 ↘
9: 9.7 ↖
10: 7.3 ↖
<b>Series 87 ( 0x)</b>
<b>175 ( 1x)</b>

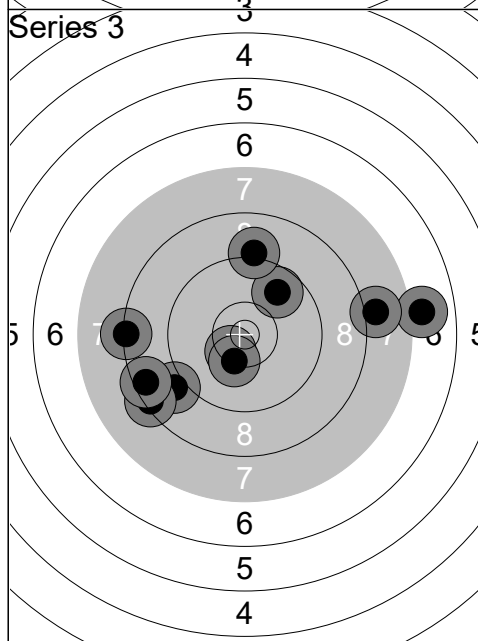

1: 7.0 →
2: 9.7 ↗
3: 9.0 ↙
4: 8.4 ↙
5: 9.1 ↑
6: 8.3 ↙
7: 10.5x ↘
8: 8.5 ↙
9: 8.0 →
10: 10.3 ↓
<b>Series 86 ( 1x)</b>
<b>261 ( 2x)</b>

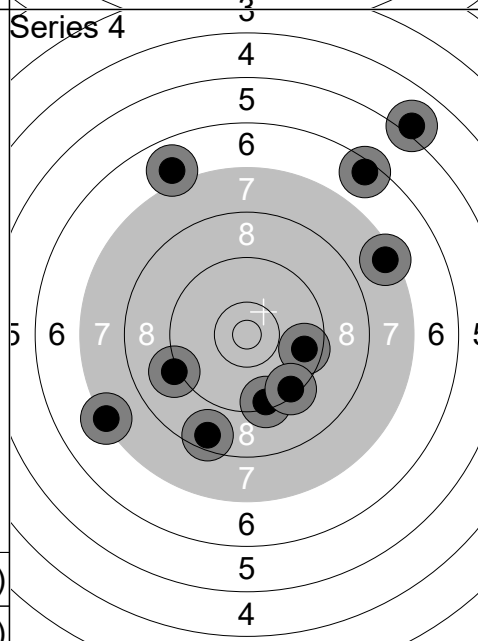

1: 6.9 ↗
2: 9.6 →
3: 7.3 ↙
4: 9.4 ↓
5: 7.4 ↗
6: 9.1 ↙
7: 8.5 ↓
8: 6.5 ↗
9: 9.4 ↘
10: 5.0 ↗
<b>Series 75 ( 0x)</b>
<b>336 ( 2x)</b>

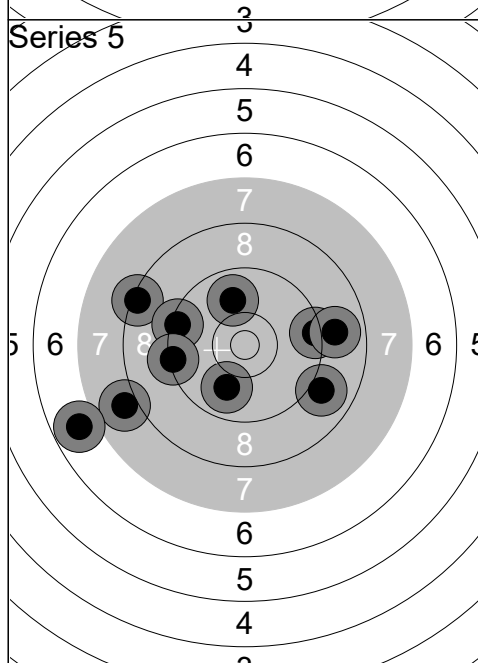

1: 8.3 ↙
2: 7.9 ↙
3: 6.8 ↙
4: 9.4 ↙
5: 9.3 →
6: 9.3 ↙
7: 9.9 ↑
8: 8.9 →
9: 9.9 ↓
10: 9.0 ↘
<b>Series 83 ( 0x)</b>
<b>419 ( 2x)</b>

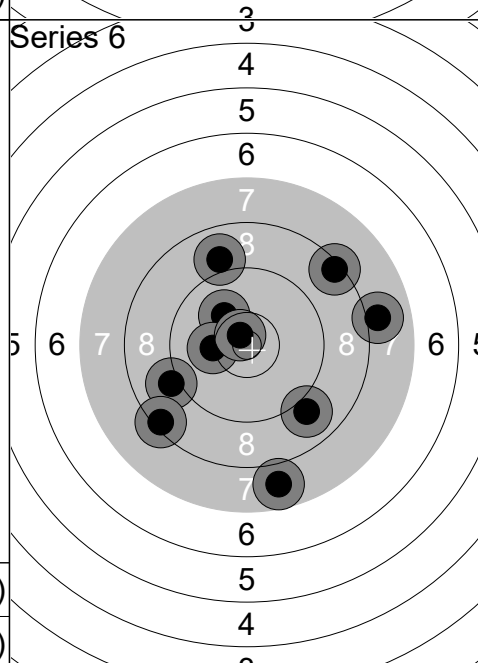

1: 9.1 ↙
2: 8.4 ↙
3: 8.4 ↗
4: 8.0 →
5: 10.1 ↖
6: 10.2 ↙
7: 10.7x ↗
8: 8.9 ↑
9: 8.9 ↘
10: 7.8 ↓
<b>Series 86 ( 1x)</b>
<b>505 ( 3x)</b>

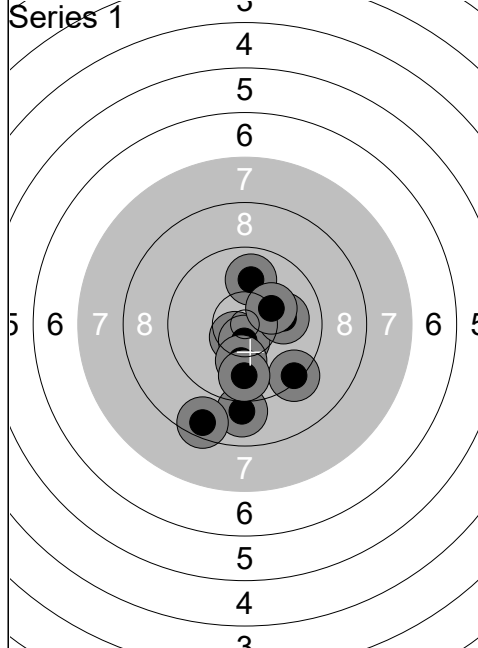

1: 10.6x ↘
2: 10.6x ↓
3: 10.1 →
4: 9.9 ↑
5: 9.3 ↘
6: 9.0 ↓
7: 10.1 ↓
8: 10.3 ↗
9: 9.8 ↓
10: 8.6 ↓
<b>Series 94 ( 2x)</b>
<b>94 ( 2x)</b>

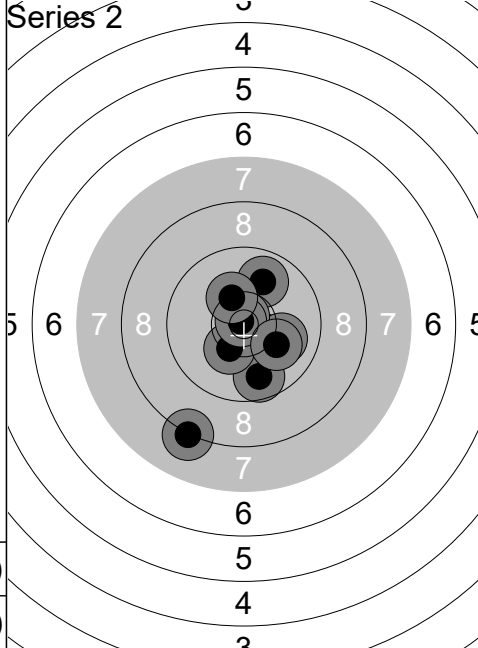

1: 9.9 ↗
2: 10.4x ↘
3: 9.7 ↓
4: 10.0 →
5: 10.8x ↑
6: 10.3 ↓
7: 10.8x ↗
8: 10.3 ↑
9: 8.2 ↓
10: 10.1 ↘
<b>Series 96 ( 3x)</b>
<b>190 ( 5x)</b>

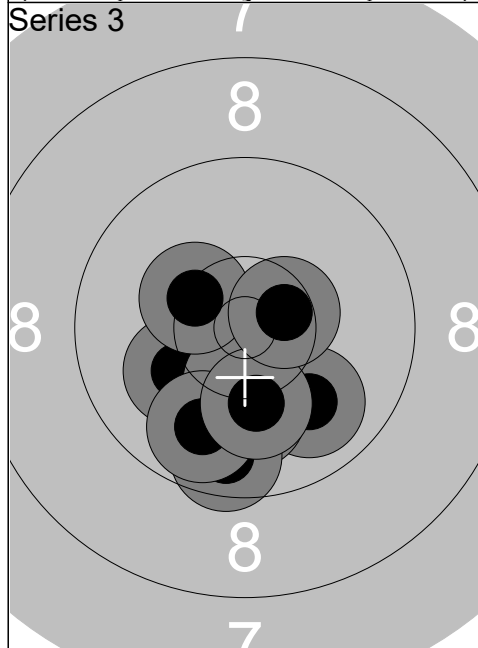

1: 10.0 ↘
2: 10.1 ↙
3: 10.3 ↓
4: 10.1 ↓
5: 9.6 ↓
6: 10.4x ↓
7: 9.9 ↓
8: 10.4x ↙
9: 10.2 ↓
10: 10.5x →
<b>Series 98 ( 3x)</b>
<b>288 ( 8x)</b>

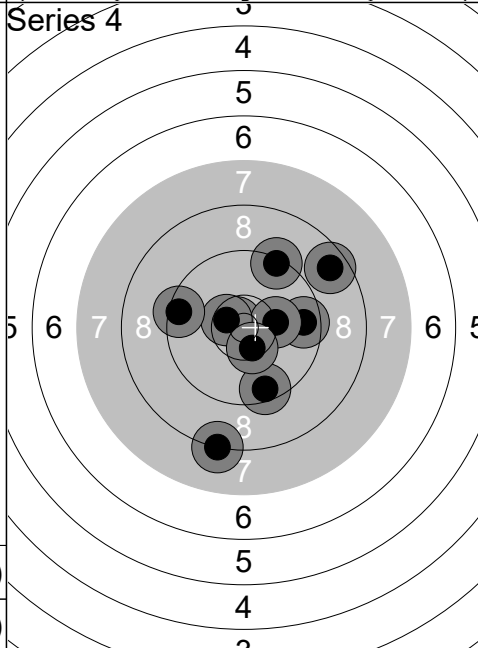

1: 9.6 →
2: 9.3 ↗
3: 10.7x ↙
4: 10.2 →
5: 10.5x ↙
6: 9.5 ↓
7: 8.2 ↓
8: 8.6 ↗
9: 10.5x ↓
10: 9.4 ←
<b>Series 92 ( 3x)</b>
<b>380 (11x)</b>

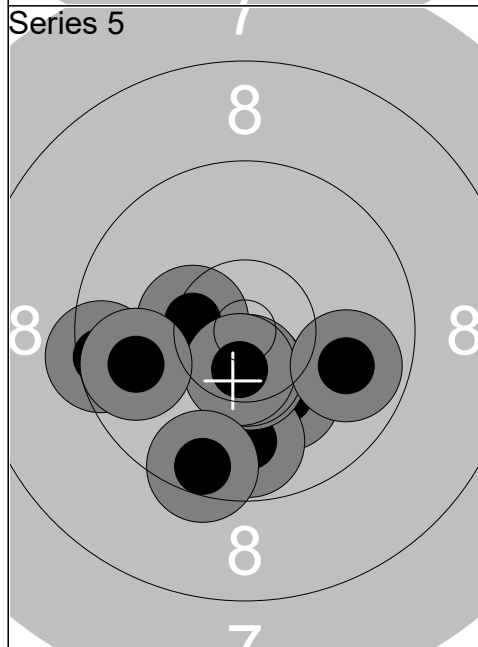

1: 10.2 ↓
2: 9.8 ↓
3: 9.5 ←
4: 10.5x ↓
5: 10.5x ↓
6: 10.4x ↙
7: 10.6x ↓
8: 9.9 →
9: 9.8 ←
10: 9.5 ↓
<b>Series 95 ( 4x)</b>
<b>475 (15x)</b>

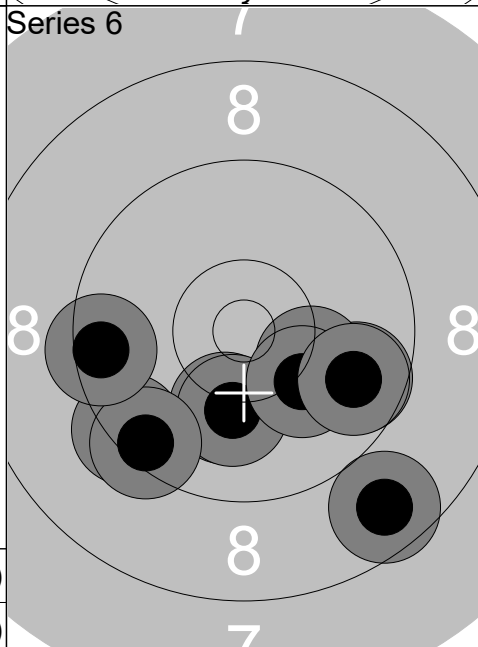

1: 9.4 ↙
2: 9.7 →
3: 10.1 ↓
4: 10.1 ↓
5: 10.2 →
6: 8.7 ↓
7: 10.2 ↓
8: 9.5 ↙
9: 9.5 ←
10: 9.7 →
<b>Series 93 ( 0x)</b>
<b>568 (15x)</b>