

Relay <b>1</b>	Lane <b>1</b>	<b>Maja Pedersen</b>			
-------------------	------------------	----------------------	--	--	--

8 Air Final Rifle Woman Ju		DEN		WJ	Rifle
----------------------------	--	-----	--	----	-------

17.02.2024		Denmark Open Air Day 02		Denmark Open Air 2024	
------------	--	-------------------------	--	-----------------------	--

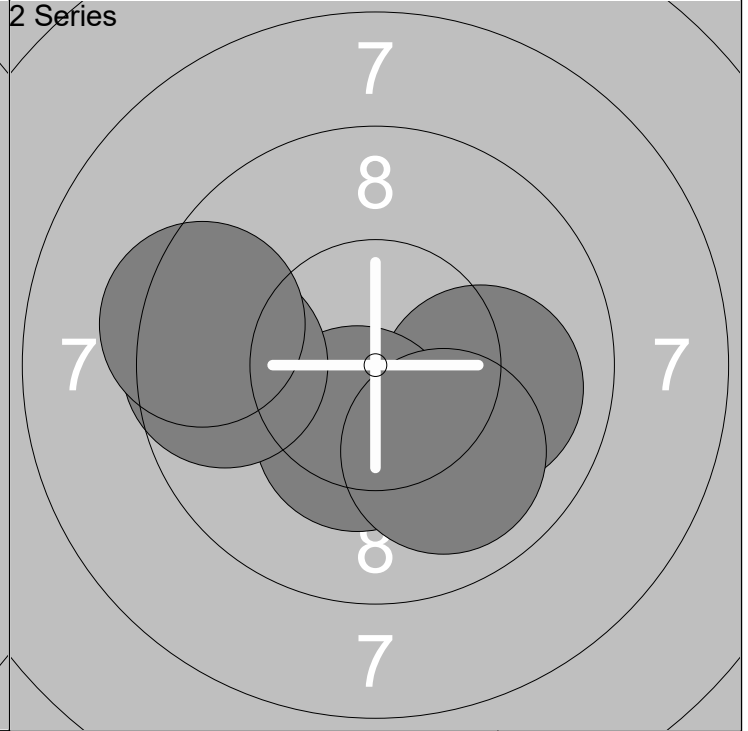
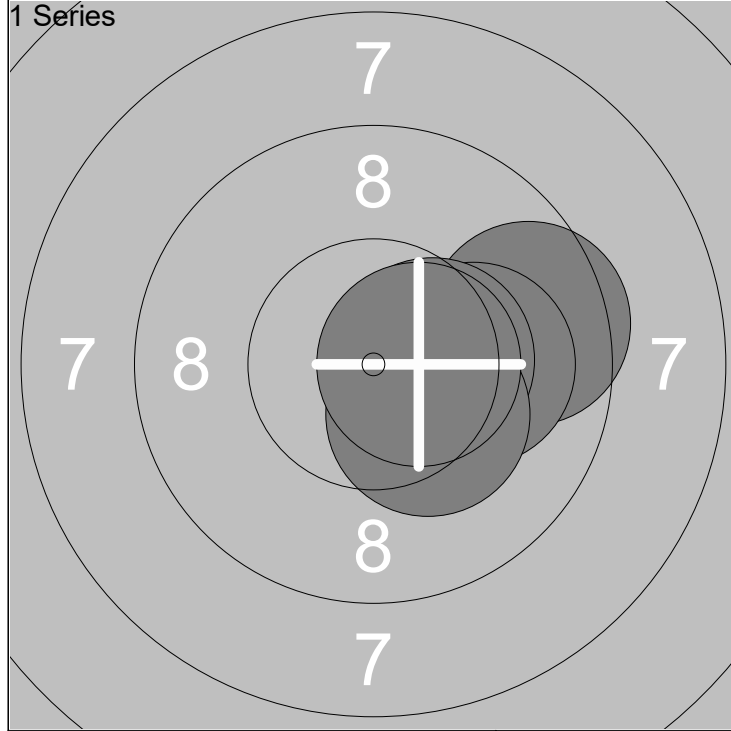

1: 9.5 →	Series	50.7
2: 10.0 →		
3: 10.4x →		
4: 10.3x ↘		
5: 10.5x →		
		50.7

1: 10.0 →	Series	49.2
2: 10.3x ↓		
3: 9.6 ←		
4: 9.9 ↘		
5: 9.4 ←		
		99.9

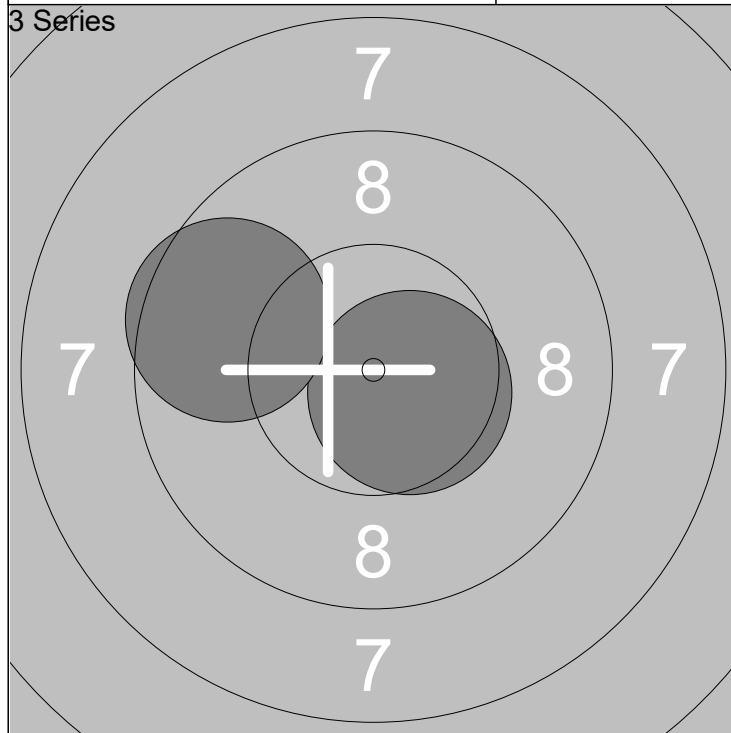

1: 10.6x ↘	Series	20.2
2: 9.6 ←		
		120.1

1: 10.6x ↓	Series	21.2
2: 10.6x ↑		
		141.3

Relay	Lane	Mathilda Gustafsson			
1	2	8 Air Final Rifle Woman Ju	SWE	WJ	Rifle
17.02.2024		Denmark Open Air Day 02		Denmark Open Air 2024	
1 Series		1: 10.0 ↘	2 Series		1: 10.8x →
		2: 10.6x ↓			2: 10.4x ↑
		3: 10.2x ↗			3: 10.5x ↗
		4: 10.7x ↗		4: 10.4x →	
		5: 9.9 ↘		5: 9.6 ←	
	Series	51.4	Series	51.7	
		51.4		103.1	
3 Series		1: 10.3x ↘	4 Series		1: 9.4 ↘
		2: 10.2x ↗			2: 10.4x ↘
		Series			20.5
		123.6		143.4	
5 Series		1: 9.8 →	6 Series		1: 9.6 ←
		2: 9.1 ←			2: 10.4x ↗
		Series			18.9
		162.3		182.3	

Relay	Lane	Rikke Bertelsen			
1	3	8 Air Final Rifle Woman Ju	DEN	WJ	Rifle
17.02.2024		Denmark Open Air Day 02		Denmark Open Air 2024	
1 Series		1: 10.0 ↗	2 Series		1: 9.9 ←
		2: 10.5x ↖			2: 10.0 ↑
		3: 10.1 ↗			3: 10.1 ←
		4: 9.2 ↖		4: 10.6x ↖	
		5: 10.7x ←		5: 10.0 ↑	
Series		50.5	Series		50.6
		50.5			101.1
3 Series		1: 10.8x ↘	4 Series		1: 10.3x ↗
		2: 10.3x ←			2: 10.2x ↑
	Series			21.1	Series
		122.2			142.7
5 Series		1: 10.6x →	6 Series		1: 10.6x ↗
		2: 10.5x ↓			2: 9.5 ←
	Series			21.1	Series
		163.8			183.9
7 Series		1: 9.9 ↗			
		2: 10.5x ←			
	Series				
		204.3			

Relay	Lane	Annabelle Borved			
1	4	8 Air Final Rifle Woman Ju	DEN	WJ	Rifle
17.02.2024		Denmark Open Air Day 02		Denmark Open Air 2024	
1 Series		1: 10.4x ↖	2 Series		1: 10.1 ←
		2: 10.7x →			2: 10.8x →
		3: 10.0 ↖			3: 9.4 ↗
		4: 10.4x ↖		4: 9.3 ↙	
		5: 10.0 ↘		5: 9.9 →	
	Series	51.5	Series	49.5	
		51.5		101.0	
3 Series		1: 9.9 ↖	4 Series		1: 10.1 ↖
		2: 10.7x ↖			2: 9.7 ↖
		Series			20.6
		121.6		141.4	
5 Series		1: 10.0 →			
		2: 10.4x ↙			
		Series	20.4		
		161.8			

Relay	Lane	Evelina Sundström			
1	5	8 Air Final Rifle Woman Ju	SWE	WJ	Rifle
17.02.2024		Denmark Open Air Day 02		Denmark Open Air 2024	
1 Series		1: 10.3x ↑	2 Series		1: 10.3x ↓
		2: 10.0 ↓			2: 10.1 ↗
		3: 10.6x ↙			3: 10.7x ↘
		4: 10.3x ↗		4: 9.8 ↗	
		5: 10.5x ↙		5: 10.4x ↙	
	Series	51.7	Series	51.3	
		51.7		103.0	
3 Series		1: 10.4x ↘	4 Series		1: 10.1 ↑
		2: 10.0 ↓			2: 9.6 →
		Series		20.4	Series
		123.4		143.1	
5 Series		1: 10.4x ↘	6 Series		1: 10.8x ↗
		2: 10.5x ↘			2: 9.4 ←
		Series		20.9	Series
		164.0		184.2	

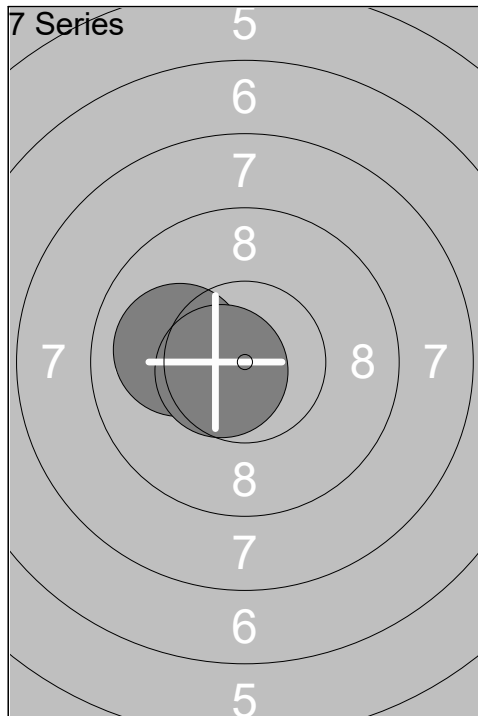

1: 10.0 ←  
2: 10.6x ↙

Series 20.6  
204.8

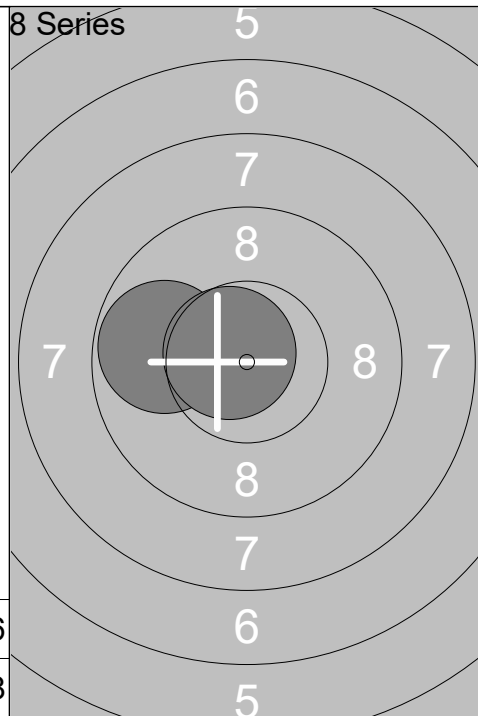

1: 9.8 ←  
2: 10.7x ↙

Series 20.5  
225.3

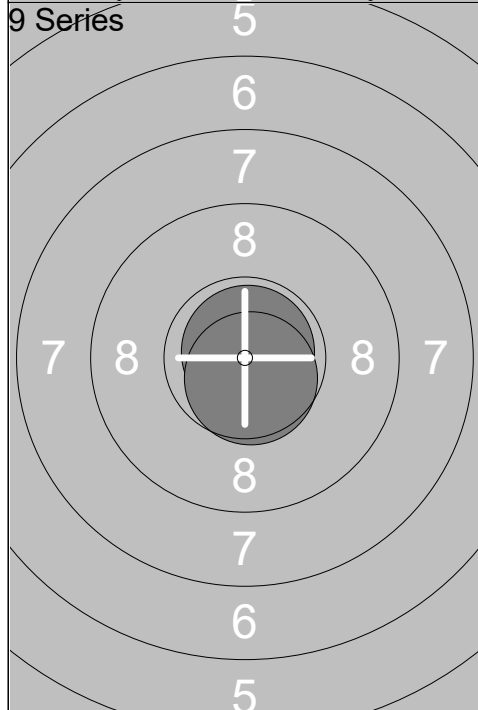

1: 10.8x ↗  
2: 10.6x ↓

Series 21.4  
246.7

Relay <b>1</b>	Lane <b>6</b>	<b>Anna Pedersen</b>
-------------------	------------------	----------------------

8 Air Final Rifle Woman Ju	DEN	WJ	Rifle
----------------------------	-----	----	-------

17.02.2024	Denmark Open Air Day 02	Denmark Open Air 2024
<b>1 Series</b> 	1: 10.3x ↘	
	2: 9.9 ↑	
	3: 10.1 ↑	
	4: 9.2 ↗	
	5: 9.1 ↑	
	<b>Series</b>	<b>48.6</b>
		<b>48.6</b>
<b>2 Series</b> 	1: 9.9 ↑	
	2: 10.1 ↑	
	3: 8.7 ↗	
	4: 10.4x ↑	
	5: 9.4 ↑	
	<b>Series</b>	<b>48.5</b>
		<b>97.1</b>
<b>3 Series</b> 	1: 10.5x →	
	2: 10.3x ↗	
	<b>Series</b>	<b>20.8</b>
		<b>117.9</b>

Relay <b>1</b>	Lane <b>7</b>	<b>Moa Hallberg</b>		
-------------------	------------------	---------------------	--	--

8 Air Final Rifle Woman Ju	SWE	WJ	Rifle
----------------------------	-----	----	-------

17.02.2024	Denmark Open Air Day 02	Denmark Open Air 2024
------------	-------------------------	-----------------------

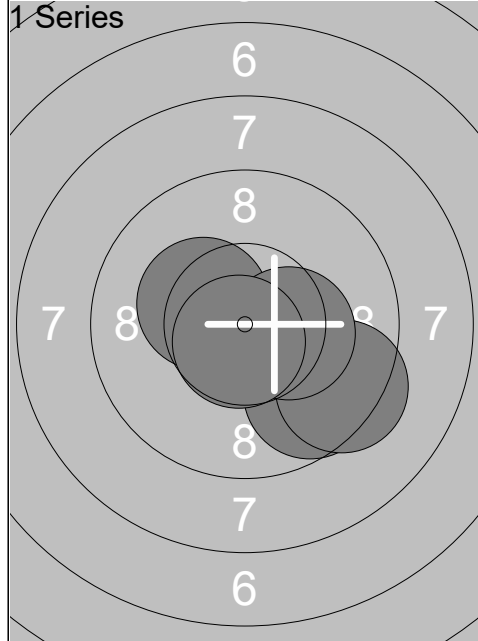

- 1: 9.7 ↘
- 2: 9.4 ↘
- 3: 10.3x ↙
- 4: 10.3x →
- 5: 10.7x ↓

Series	50.4
	50.4

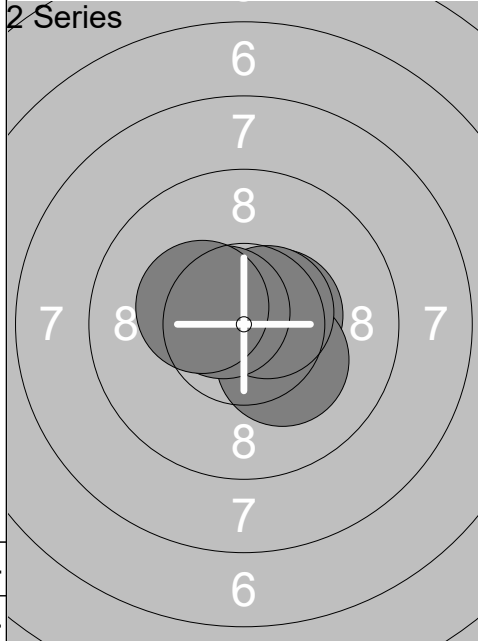

- 1: 10.5x →
- 2: 10.2x ↘
- 3: 10.6x →
- 4: 10.6x ↙
- 5: 10.3x ↙

Series	52.2
	102.6

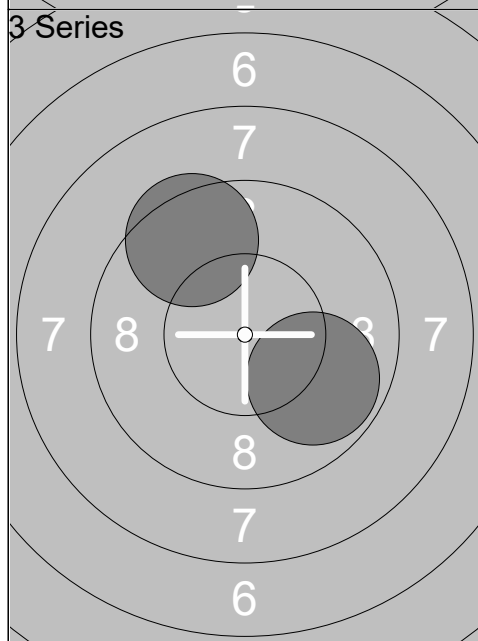

- 1: 9.5 ↗
- 2: 9.8 ↘

Series	19.3
	121.9

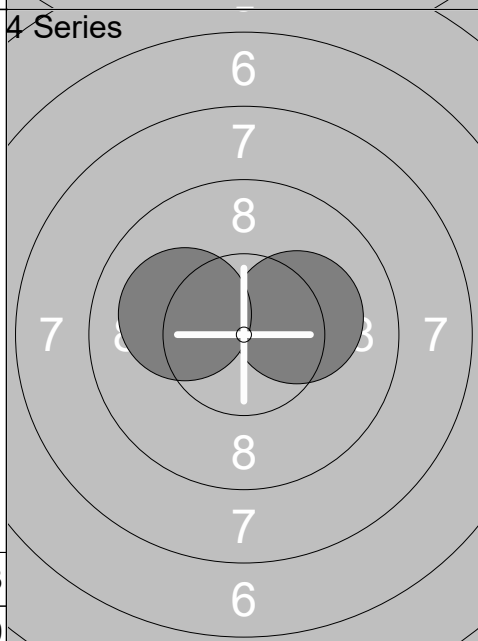

- 1: 10.2x →
- 2: 10.1 ↙

Series	20.3
	142.2

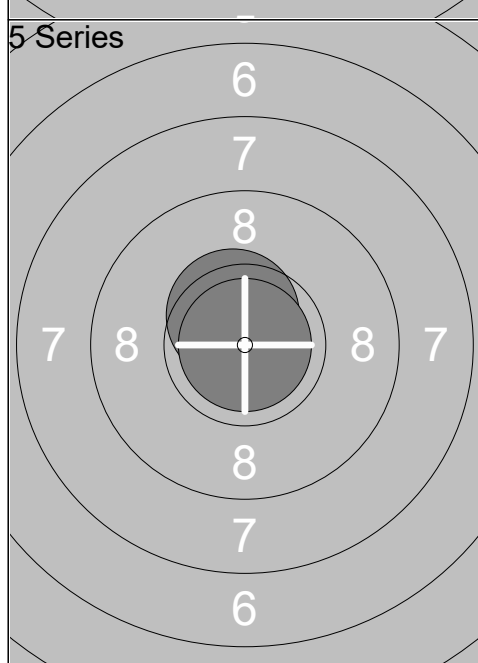

- 1: 10.5x ↗
- 2: 10.9x

Series	21.4
	163.6

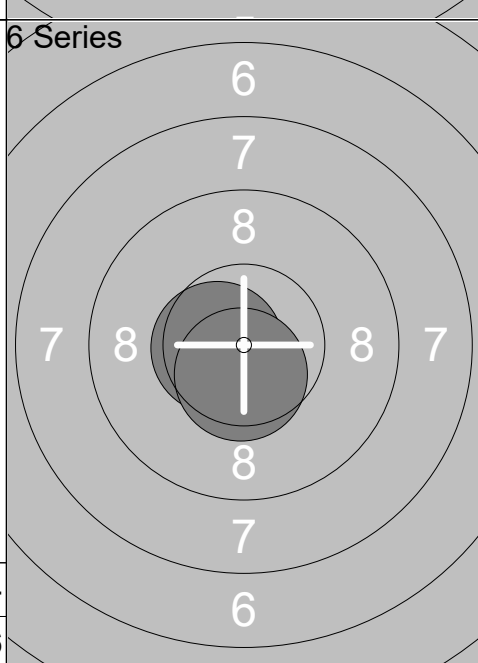

- 1: 10.6x ↙
- 2: 10.5x ↓

Series	21.1
	184.7



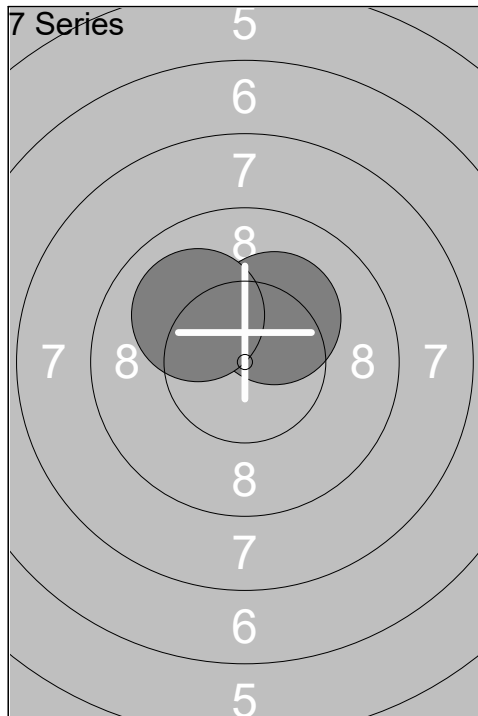

1: 10.2x ↗  
2: 10.0 ↖

Series 20.2  
204.9

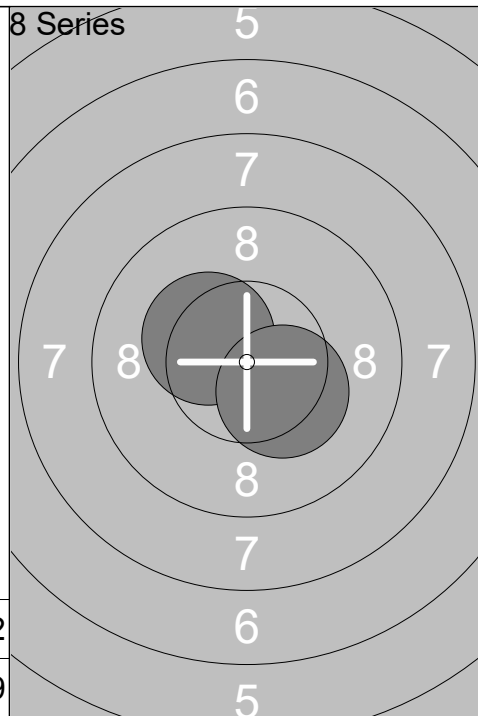

1: 10.3x ↖  
2: 10.3x ↘

Series 20.6  
225.5

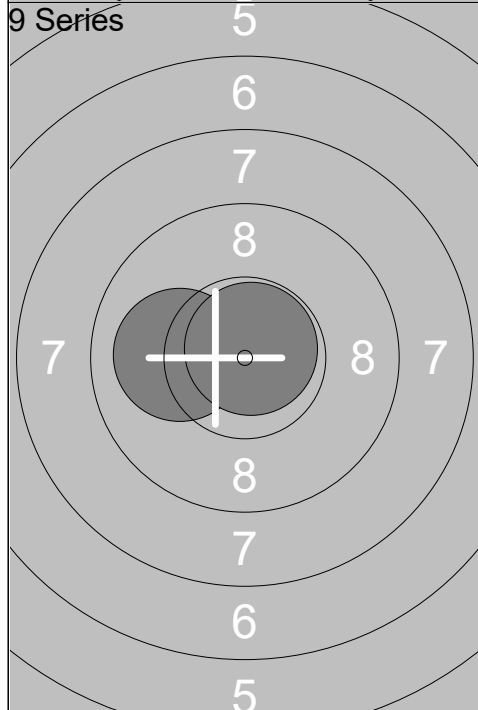

1: 10.0 ←  
2: 10.8x ↗

Series 20.8  
246.3

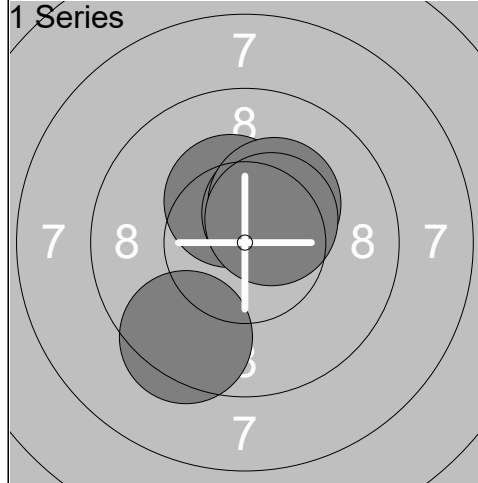

1:	10.3x	↖
2:	10.4x	↗
3:	10.2x	↗
4:	9.4	↘
5:	10.4x	↗
<b>Series</b>		50.7
		50.7

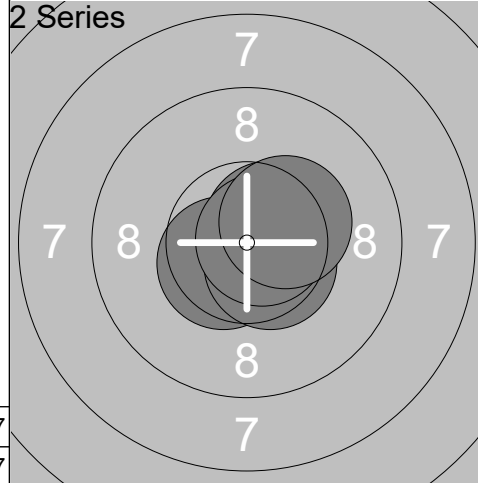

1:	10.6x	↗
2:	10.5x	↘
3:	10.5x	↘
4:	10.7x	→
5:	10.3x	↗
<b>Series</b>		52.6
		103.3

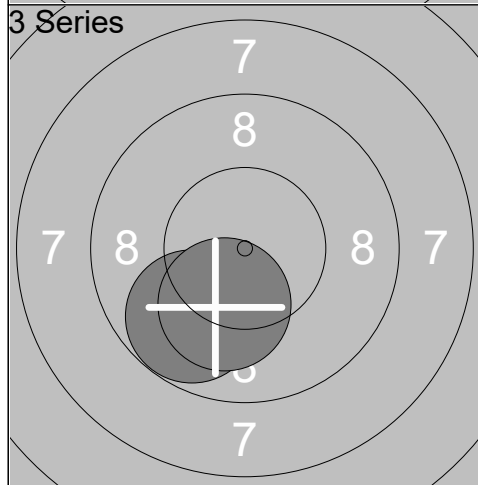

1:	9.8	↘
2:	10.1	↘
<b>Series</b>		19.9
		123.2

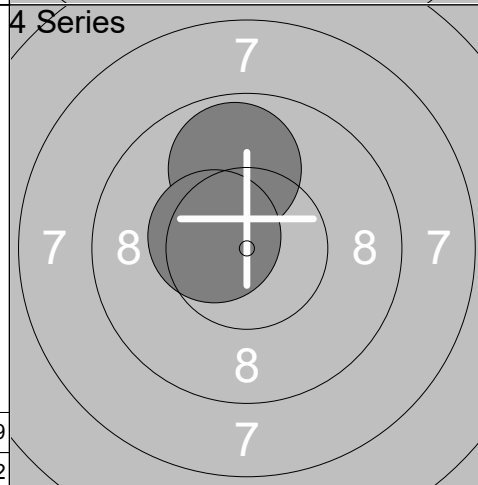

1:	9.8	↑
2:	10.5x	↖
<b>Series</b>		20.3
		143.5

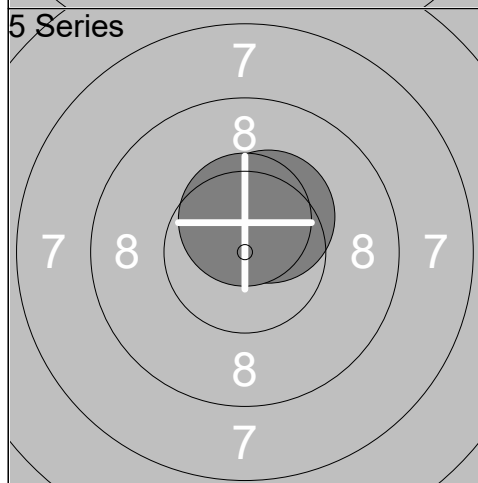

1:	10.4x	↗
2:	10.5x	↑
<b>Series</b>		20.9
		164.4

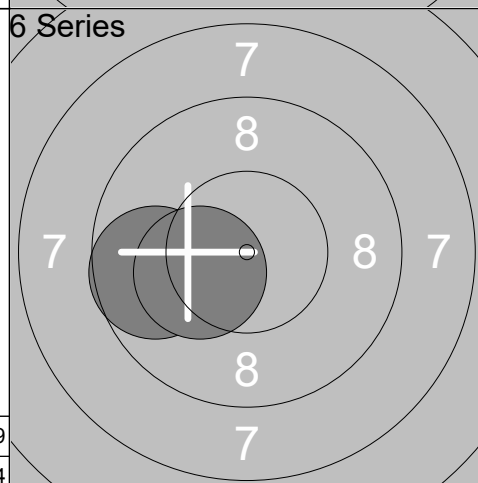

1:	9.7	↖
2:	10.2x	↖
<b>Series</b>		19.9
		184.3

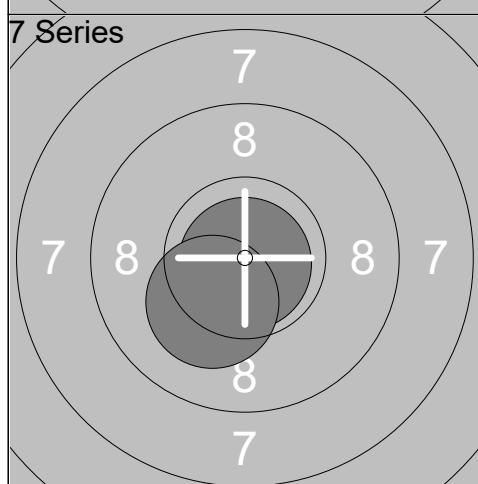

1:	10.8x	↘
2:	10.2x	↘
<b>Series</b>		21.0
		205.3

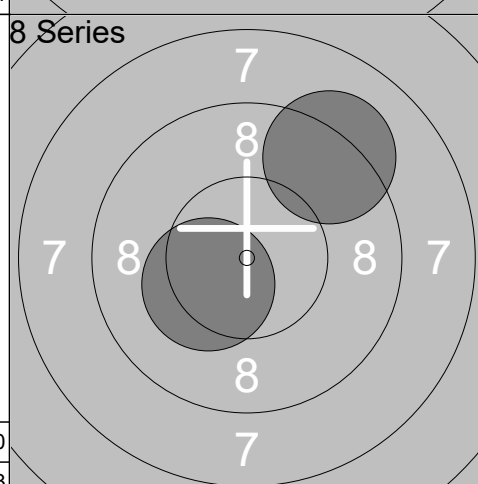

1:	9.2	↗
2:	10.3x	↖
<b>Series</b>		19.5
		224.8