

Relay	Lane	Isac Ahlqvist		
1 Air	SWE	Mp	Pistol	
18.02.2024	Denmark Open Air Day 3	Denmark Open Air 2024		
Series 1 	1: 9.9 ↘	Series 2 	1: 10.2 →	
	2: 9.1 ↗		2: 8.4 ↗	
	3: 10.6x ↙		3: 10.1 ↗	
	4: 9.9 →		4: 9.8 ↗	
	5: 9.2 ↗		5: 10.0 ←	
	6: 10.6x ↗		6: 10.0 ←	
	7: 9.3 ←		7: 9.3 ↙	
	8: 9.0 ←		8: 9.5 ↘	
	9: 10.6x ↗		9: 9.9 ↘	
	10: 10.3 ↘		10: 10.4x ↗	
	Series 94 (3x)		Series 94 (1x)	
	94 (3x)		188 (4x)	
Series 3 	1: 10.4x ←	Series 4 	1: 9.9 ↘	
	2: 10.1 ↗		2: 9.4 ↘	
	3: 9.1 ↘		3: 9.2 ↘	
	4: 10.0 ↘		4: 9.3 ↗	
	5: 10.2 ↘		5: 10.3 ↗	
	6: 10.3 ↘		6: 10.5x ←	
	7: 9.9 ↙		7: 10.4x ↘	
	8: 9.1 ↘		8: 10.8x →	
	9: 9.7 ↘		9: 10.6x ↘	
	10: 9.5 ↘		10: 9.7 ↘	
	Series 95 (1x)		Series 95 (4x)	
	283 (5x)		378 (9x)	
Series 5 	1: 10.2 ↘	Series 6 	1: 8.9 ↘	
	2: 10.2 ↘		2: 10.5x →	
	3: 9.6 ↗		3: 10.2 ←	
	4: 9.4 ↘		4: 10.4x ↘	
	5: 10.0 ↘		5: 9.1 ↘	
	6: 10.1 ↙		6: 10.3 ←	
	7: 10.6x ↘		7: 10.5x ↙	
	8: 10.0 ↘		8: 10.0 ←	
	9: 10.4x ↘		9: 9.9 ↘	
	10: 10.1 ↘		10: 9.0 ↗	
	Series 98 (2x)		Series 95 (3x)	
	476 (11x)		571 (14x)	

Relay	Lane	Bernt Alpenhoff			
1	2	SWE	Mp	Pistol	
18.02.2024	Denmark Open Air Day 3	Denmark Open Air 2024			
Series 1 	1:	8.0 ↖	Series 2 	1:	7.9 ↖
	2:	10.2 →		2:	8.8 ←
	3:	10.1 →		3:	9.4 ↑
	4:	10.8x ↗		4:	10.0 ↗
	5:	9.5 ←		5:	9.5 ↗
	6:	9.6 ↑		6:	9.3 ↖
	7:	9.5 ↘		7:	9.9 ↑
	8:	9.1 ↗		8:	9.6 ←
	9:	9.4 ←		9:	9.0 ←
	10:	9.6 ↗		10:	8.4 ←
Series		92 (1x)	Series		87 (0x)
		92 (1x)			179 (1x)
Series 3 	1:	9.1 ←	Series 4 	1:	9.0 ←
	2:	10.1 ↘		2:	9.6 ↑
	3:	10.0 →		3:	9.0 ←
	4:	10.3 ←		4:	8.5 ↗
	5:	9.1 ←		5:	10.1 ←
	6:	8.8 ↘		6:	9.7 ↘
	7:	9.5 ↘		7:	9.1 ↘
	8:	10.0 ←		8:	10.0 ←
	9:	8.6 ↘		9:	9.1 ↗
	10:	10.1 ↘		10:	10.1 ↘
Series		93 (0x)	Series		92 (0x)
		272 (1x)			364 (1x)
Series 5 	1:	10.5x ↑	Series 6 	1:	9.5 ←
	2:	9.3 ↖		2:	9.9 ↗
	3:	10.2 ↘		3:	9.5 ←
	4:	9.8 ↗		4:	10.7x ←
	5:	9.3 →		5:	9.9 ↘
	6:	10.0 ↘		6:	10.0 ←
	7:	10.7x ↖		7:	10.3 ↗
	8:	10.0 ←		8:	10.4x ↑
	9:	9.9 ↘		9:	10.6x ↗
	10:	10.4x ↘		10:	9.9 ↗
Series		96 (3x)	Series		95 (3x)
		460 (4x)			555 (7x)

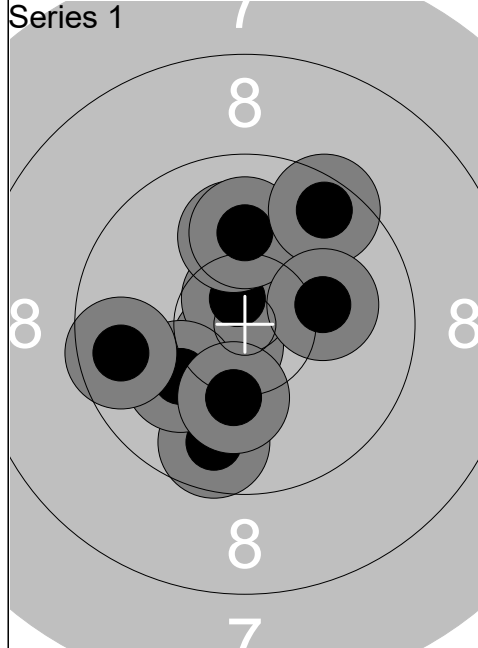

1:	9.7	↓
2:	10.7x	↙
3:	10.7x	↗
4:	10.1	↙
5:	10.0	↑
6:	9.7	←
7:	10.0	↑
8:	9.5	↗
9:	10.1	→
10:	10.2	↓
Series	97 (2x)	
	97 (2x)	

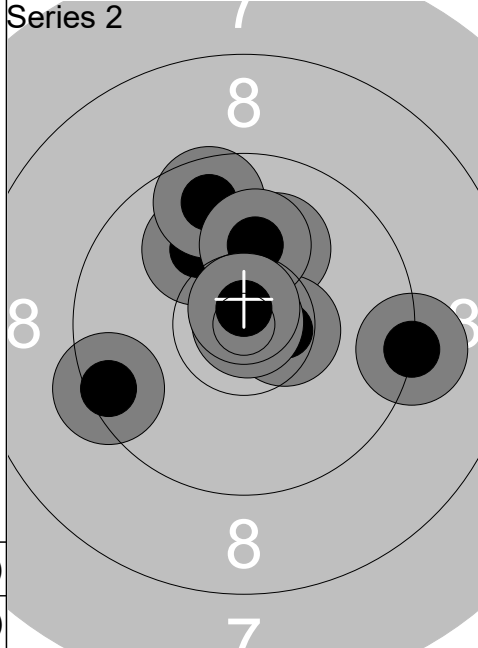

1:	10.1	↗
2:	10.1	↑
3:	10.1	↖
4:	9.2	→
5:	10.5x	→
6:	9.7	↑
7:	10.9x	↗
8:	10.1	↑
9:	10.8x	↑
10:	9.4	↙
Series	97 (3x)	
	194 (5x)	

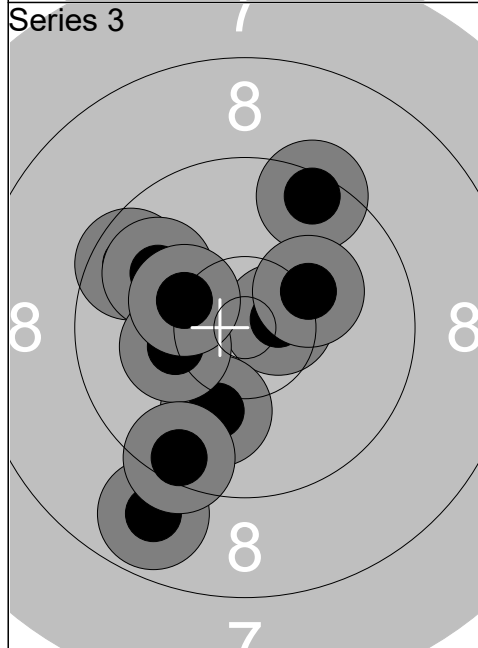

1:	10.6x	→
2:	9.6	↖
3:	9.5	↗
4:	8.8	↓
5:	9.9	↖
6:	10.2	↗
7:	10.1	↓
8:	10.2	←
9:	10.3	↖
10:	9.5	↓
Series	94 (1x)	
	288 (6x)	

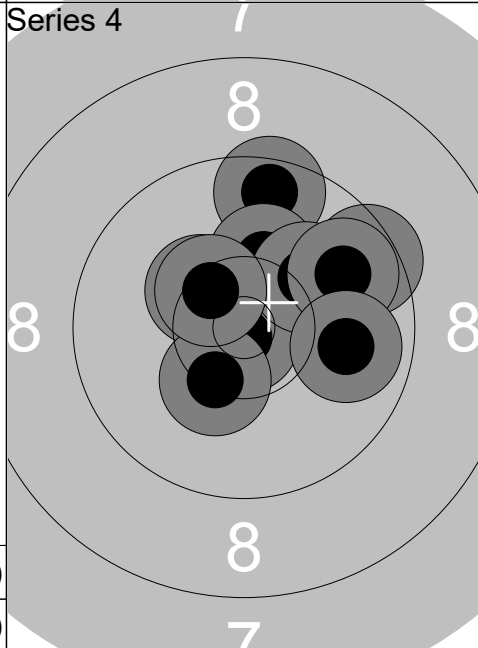

1:	10.4x	↖
2:	9.6	↑
3:	10.2	↑
4:	10.8x	↓
5:	9.5	↗
6:	10.3	↓
7:	10.1	↗
8:	9.8	↗
9:	9.9	→
10:	10.4x	↖
Series	96 (3x)	
	384 (9x)	

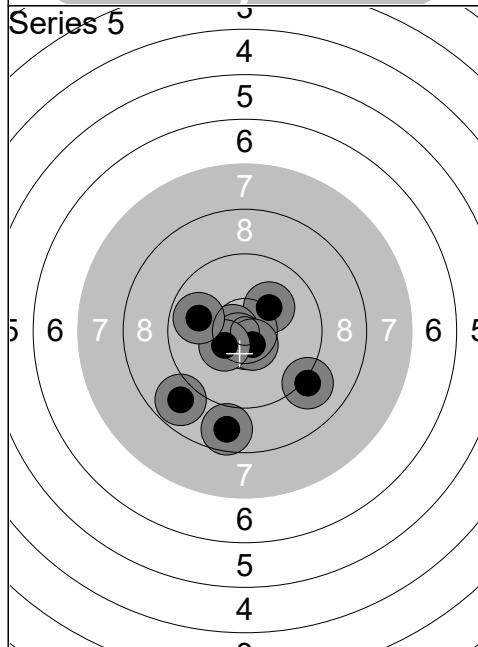

1:	8.7	↓
2:	10.2	↗
3:	8.8	↙
4:	10.7x	↙
5:	9.1	↘
6:	10.7x	↓
7:	10.7x	↙
8:	10.6x	↘
9:	10.4x	↙
10:	9.9	←
Series	94 (5x)	
	478 (14x)	

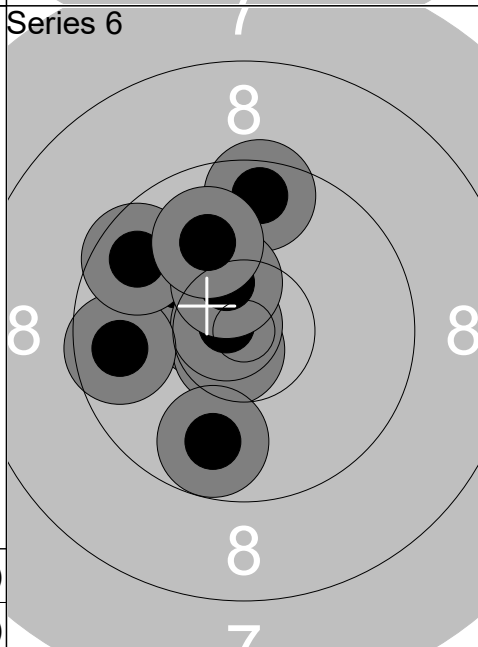

1:	10.6x	↙
2:	10.1	↖
3:	10.7x	↙
4:	10.8x	↙
5:	9.6	↑
6:	9.7	←
7:	9.6	↖
8:	10.4x	↑
9:	9.8	↓
10:	10.0	↑
Series	96 (4x)	
	574 (18x)	

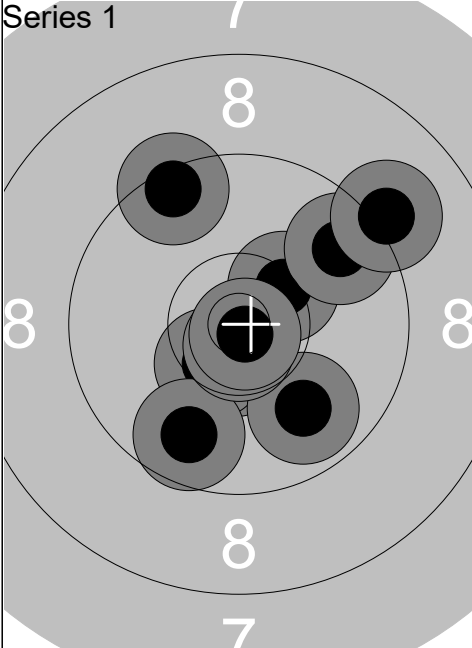
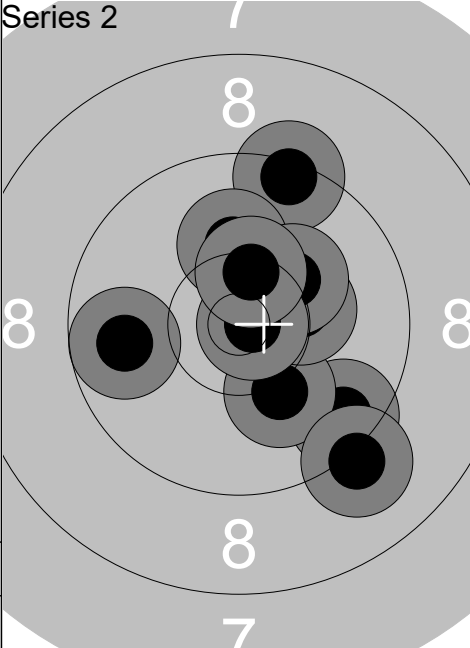
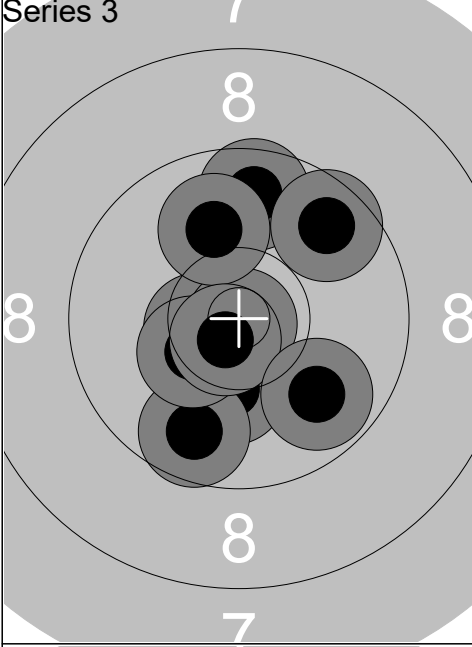
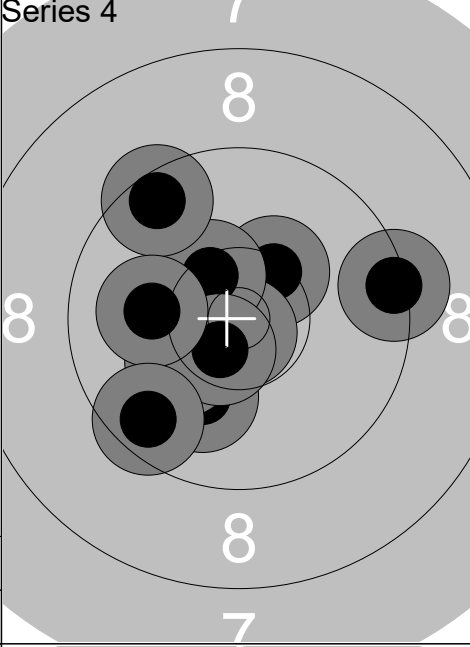
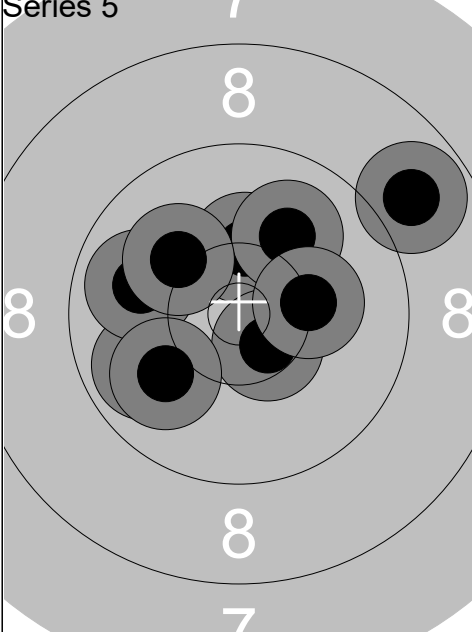
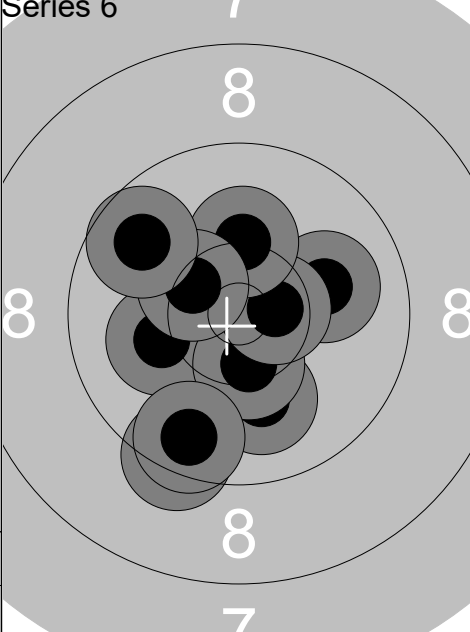
Relay	Lane	Arjun Singh Cheema			
1 Air		IND	Mp	Pistol	
18.02.2024		Denmark Open Air Day 3	Denmark Open Air 2024		
Series 1		1: 10.3 ↗ 2: 10.6x ↓ 3: 10.4x ↙ 4: 9.9 ↘ 5: 9.7 ↗ 6: 9.7 ↓ 7: 10.7x ↓ 8: 9.1 ↗ 9: 10.8x ↓ 10: 9.4 ↖	Series 2		1: 9.6 ↘ 2: 9.8 ← 3: 10.1 ↘ 4: 9.4 ↗ 5: 10.3 → 6: 10.1 ↗ 7: 10.2 ↗ 8: 10.8x → 9: 10.4x ↗ 10: 9.1 ↘
		Series 95 (4x) 95 (4x)		Series 96 (2x) 191 (6x)	
Series 3		1: 10.2 ↓ 2: 9.7 ↓ 3: 9.7 ↗ 4: 9.7 ↗ 5: 10.5x ← 6: 10.9x ↓ 7: 10.0 ↗ 8: 10.4x ← 9: 10.7x ↓ 10: 9.8 ↘	Series 4		1: 10.3 ↗ 2: 10.8x ↓ 3: 10.1 ↓ 4: 9.3 → 5: 10.4x ↖ 6: 9.5 ↖ 7: 10.2 ↙ 8: 10.6x ↓ 9: 10.1 ← 10: 9.6 ↘
		Series 96 (4x) 287 (10x)		Series 97 (3x) 384 (13x)	
Series 5		1: 9.9 ← 2: 10.4x → 3: 10.3 ↗ 4: 9.9 ← 5: 10.0 ↗ 6: 10.5x ↓ 7: 10.2 → 8: 10.0 ↙ 9: 8.8 ↗ 10: 10.1 ↖	Series 6		1: 10.1 ↓ 2: 10.1 ← 3: 10.0 → 4: 9.4 ↓ 5: 10.4x ↓ 6: 9.6 ↓ 7: 10.6x → 8: 10.2 ↗ 9: 10.4x ↖ 10: 9.7 ↖
		Series 96 (2x) 480 (15x)		Series 97 (3x) 577 (18x)	

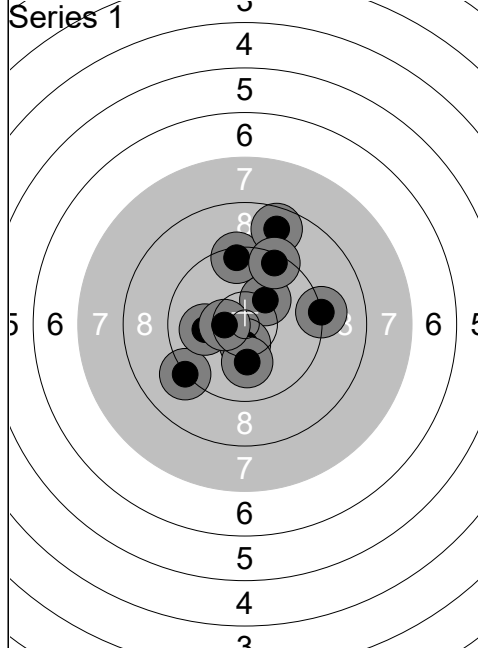

1:	9.2	↙
2:	10.2	↗
3:	9.4	↑
4:	8.7	↑
5:	10.1	←
6:	9.4	↑
7:	9.2	→
8:	10.5x	↓
9:	10.1	↓
10:	10.5x	←
Series	94 (2x)	
	94 (2x)	

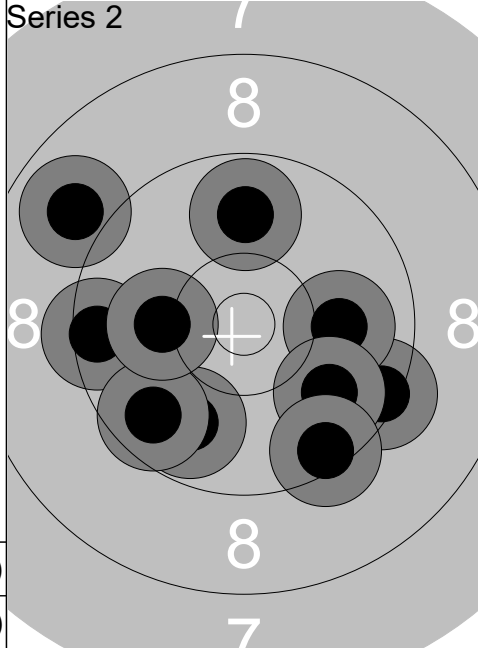

1:	9.5	←
2:	9.8	↓
3:	9.4	↘
4:	9.8	↑
5:	8.9	↖
6:	9.7	↓
7:	10.1	←
8:	10.0	→
9:	9.8	↘
10:	9.4	↓
Series	91 (0x)	
	185 (2x)	

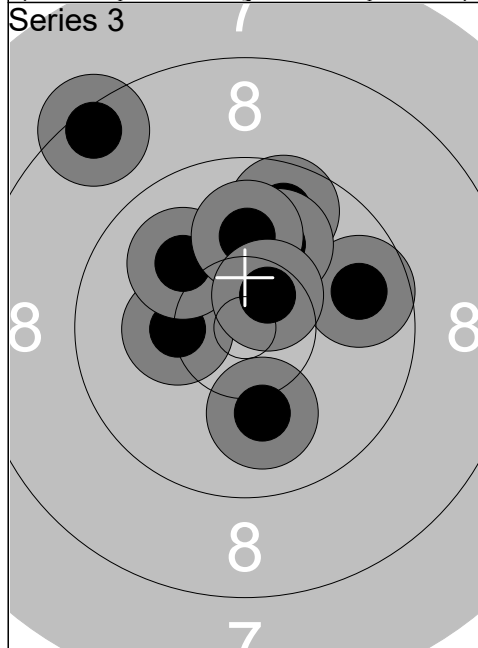

1:	9.7	→
2:	10.3	↑
3:	9.7	↑
4:	10.3	←
5:	10.0	↖
6:	10.1	↓
7:	10.0	↑
8:	10.0	↑
9:	10.6x	↗
10:	8.4	↖
Series	96 (1x)	
	281 (3x)	

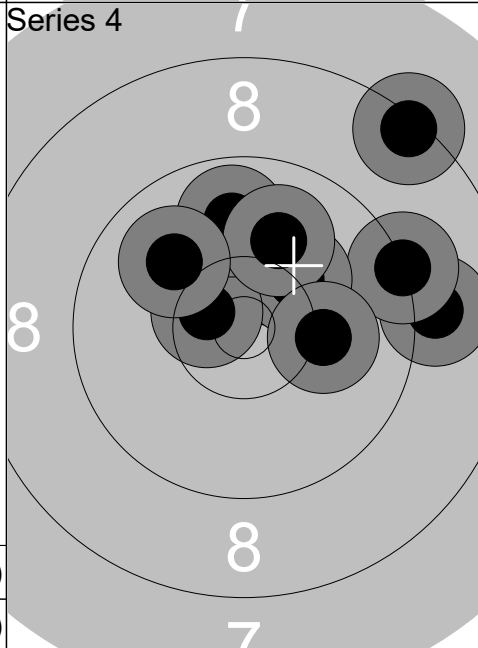

1:	9.0	→
2:	10.3	↑
3:	9.2	→
4:	10.2	↗
5:	10.5x	↖
6:	9.9	↑
7:	10.0	↑
8:	10.0	↖
9:	8.3	↗
10:	10.1	→
Series	95 (1x)	
	376 (4x)	

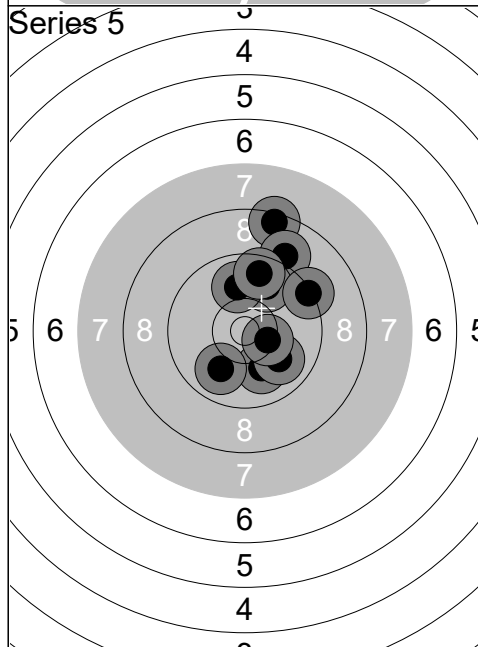

1:	8.4	↑
2:	9.1	↑
3:	9.8	↑
4:	9.3	↗
5:	10.0	↓
6:	10.0	↘
7:	10.0	↑
8:	9.6	↑
9:	9.9	↓
10:	10.4x	↘
Series	93 (1x)	
	469 (5x)	

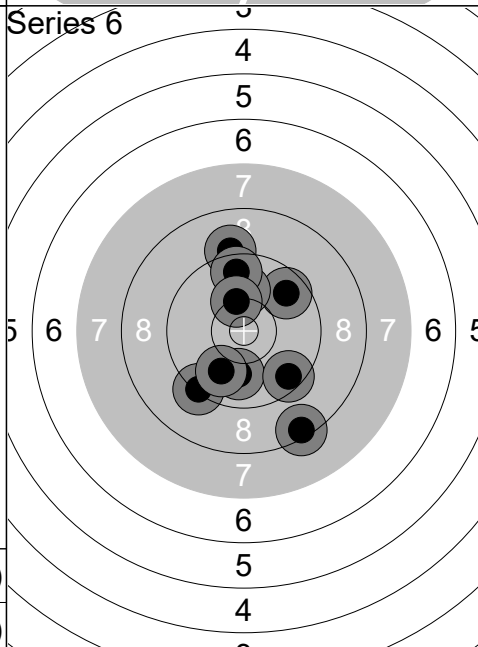

1:	9.3	↓
2:	9.7	↗
3:	8.4	↓
4:	10.0	↓
5:	10.0	↑
6:	9.1	↑
7:	9.9	↓
8:	9.6	↑
9:	9.5	↘
10:	10.3	↑
Series	92 (0x)	
	561 (5x)	

Relay	Lane	Jonas Kofoed Hansen		
1 Air		DEN	Mp	Pistol
18.02.2024		Denmark Open Air Day 3	Denmark Open Air 2024	
Series 1		1: 10.1 →	Series 2	1: 9.4 ↘
		2: 9.8 ↗		2: 10.1 ↖
		3: 10.7x →		3: 10.3 →
		4: 10.1 ←		4: 10.1 ↗
		5: 9.3 →		5: 9.8 ↘
		6: 9.9 →		6: 10.8x ↑
		7: 9.9 ←		7: 10.4x →
		8: 10.9x ↘		8: 10.2 ↘
		9: 9.1 ↘		9: 9.5 ↘
		10: 9.5 ←		10: 9.7 ←
		Series 94 (2x)		Series 96 (2x)
		94 (2x)		190 (4x)
Series 3		1: 9.5 →	Series 4	1: 10.6x ↑
		2: 8.7 ↘		2: 10.1 ↘
		3: 10.3 ↓		3: 10.7x →
		4: 9.7 →		4: 10.3 →
		5: 10.1 ↓		5: 10.1 ↓
		6: 9.4 ↗		6: 9.8 →
		7: 10.7x ↓		7: 10.6x ↗
		8: 9.9 ↘		8: 9.7 ←
		9: 9.8 ↘		9: 10.7x ↖
		10: 10.3 ←		10: 9.4 ↘
		Series 93 (1x)		Series 97 (4x)
		283 (5x)		380 (9x)
Series 5		1: 9.0 →	Series 6	1: 9.5 ↗
		2: 9.9 ↘		2: 10.0 ↘
		3: 9.6 ←		3: 9.6 ↘
		4: 10.4x ↖		4: 10.6x ↑
		5: 9.9 ←		5: 10.4x ↖
		6: 10.3 ↓		6: 10.8x ↗
		7: 10.5x ↓		7: 9.6 ←
		8: 10.3 ↗		8: 10.1 →
		9: 9.5 ↘		9: 9.7 ↘
		10: 10.1 ↓		10: 10.3 →
		Series 95 (2x)		Series 96 (3x)
		475 (11x)		571 (14x)

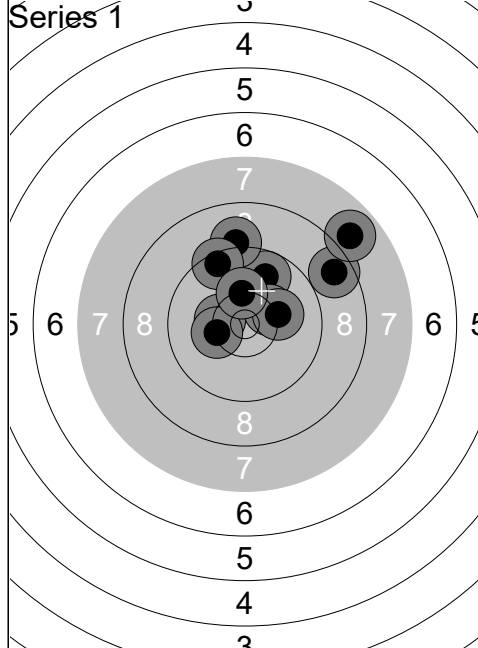

1:	8.6	↗
2:	9.8	↗
3:	9.1	↑
4:	7.9	↗
5:	10.4x	↙
6:	10.3	↗
7:	10.3	←
8:	10.2	→
9:	9.5	↖
10:	10.3	↑
Series	92 (1x)	
	92 (1x)	

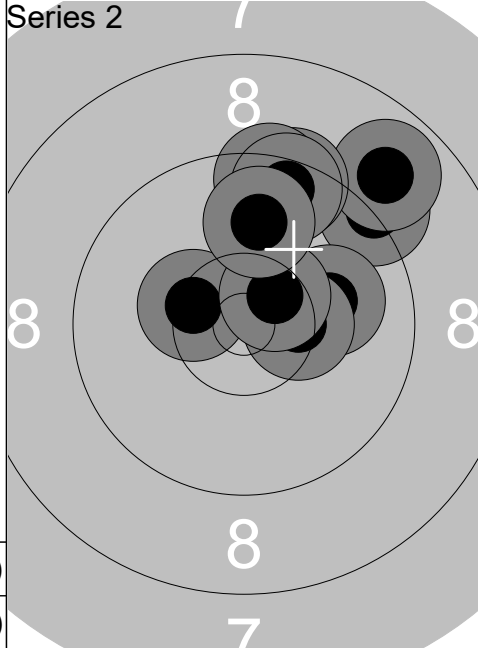

1:	9.2	↗
2:	10.0	→
3:	10.4x	→
4:	8.9	↗
5:	10.4x	↙
6:	9.4	↗
7:	9.5	↑
8:	10.5x	↗
9:	9.5	↗
10:	9.9	↑
Series	93 (3x)	
	185 (4x)	

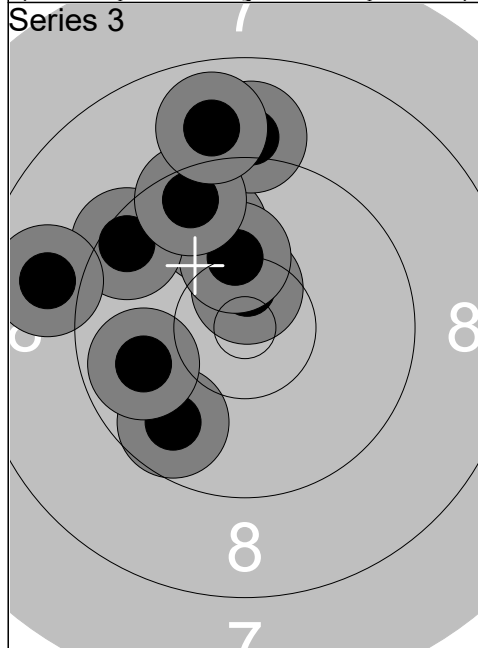

1:	9.7	↙
2:	10.5x	↑
3:	9.9	↗
4:	10.2	↑
5:	9.5	↖
6:	9.9	←
7:	9.0	↑
8:	8.9	←
9:	9.5	↗
10:	8.9	↑
Series	90 (1x)	
	275 (5x)	

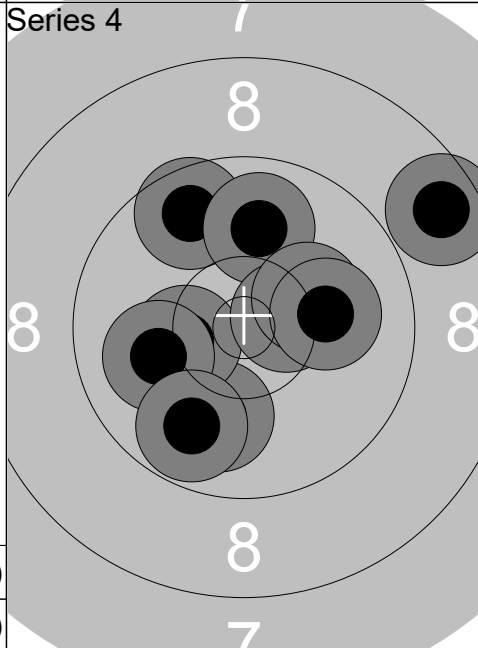

1:	10.0	↓
2:	9.7	↖
3:	10.3	←
4:	10.0	←
5:	9.9	↑
6:	10.5x	→
7:	9.8	↓
8:	10.2	↗
9:	8.6	↗
10:	10.1	→
Series	95 (1x)	
	370 (6x)	

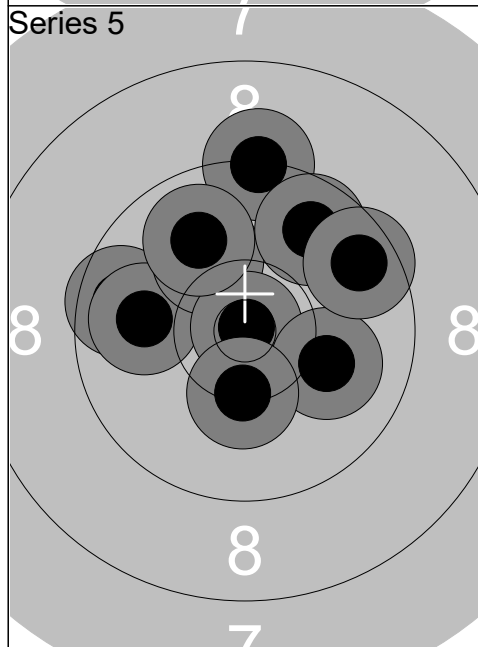

1:	9.3	↑
2:	9.7	←
3:	9.9	←
4:	10.1	↗
5:	10.9x	↗
6:	9.9	↗
7:	9.7	↗
8:	10.1	→
9:	10.3	↓
10:	9.6	↗
Series	94 (1x)	
	464 (7x)	

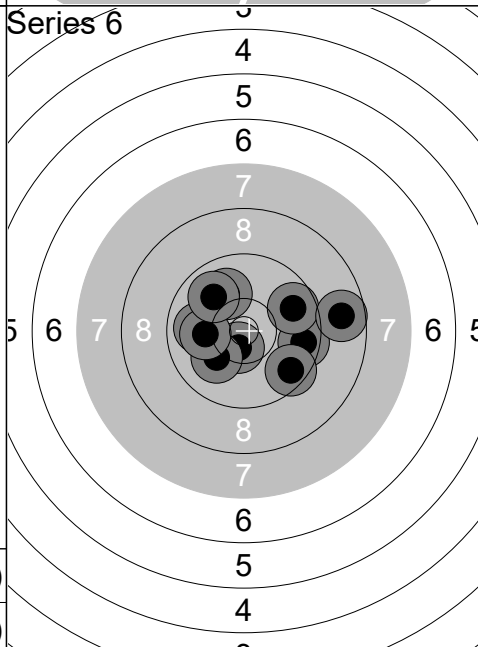

1:	9.9	←
2:	10.6x	↓
3:	9.6	→
4:	9.8	↗
5:	10.1	↙
6:	10.0	↗
7:	10.1	←
8:	9.9	↗
9:	8.8	→
10:	9.6	↘
Series	93 (1x)	
	557 (8x)	

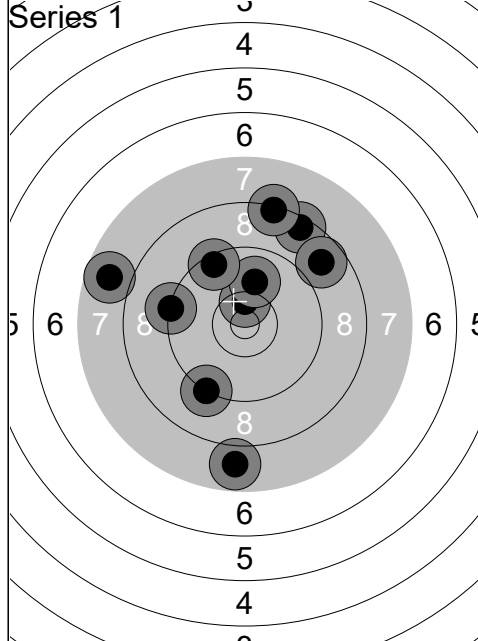

1: 9.3 ←
2: 10.4x ↑
3: 8.5 ↗
4: 8.7 ↗
5: 7.8 ↓
6: 9.2 ↓
7: 10.0 ↑
8: 7.8 ←
9: 9.4 ↗
10: 8.3 ↑
Series 85 (1x)
85 (1x)

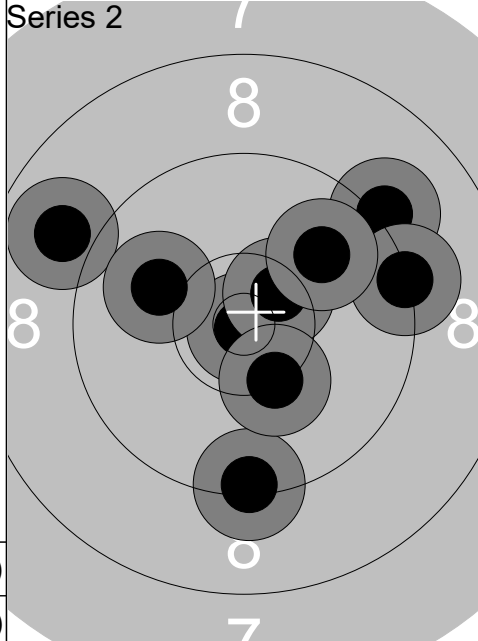

1: 8.9 ↖
2: 10.9x ↓
3: 9.1 ↗
4: 0.0
5: 9.3 →
6: 9.3 ↓
7: 10.5x ↗
8: 10.0 ←
9: 10.3 ↓
10: 9.9 ↗
Series 84 (2x)
169 (3x)

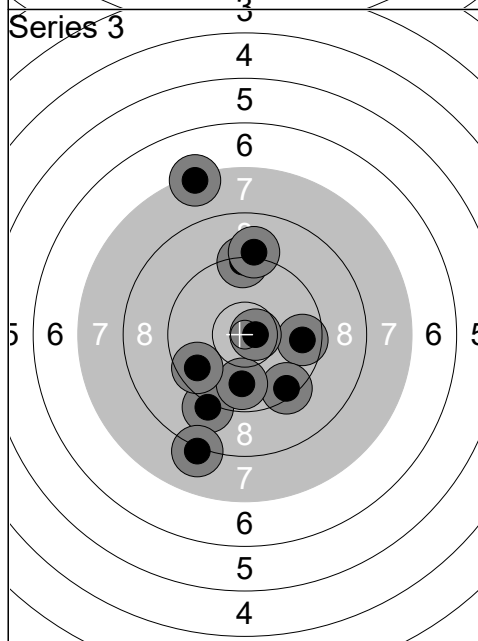

1: 7.3 ↑
2: 9.7 →
3: 9.3 ↑
4: 9.1 ↑
5: 9.4 ↓
6: 9.1 ↓
7: 9.9 ↓
8: 9.6 ←
9: 10.7x →
10: 8.1 ↓
Series 88 (1x)
257 (4x)

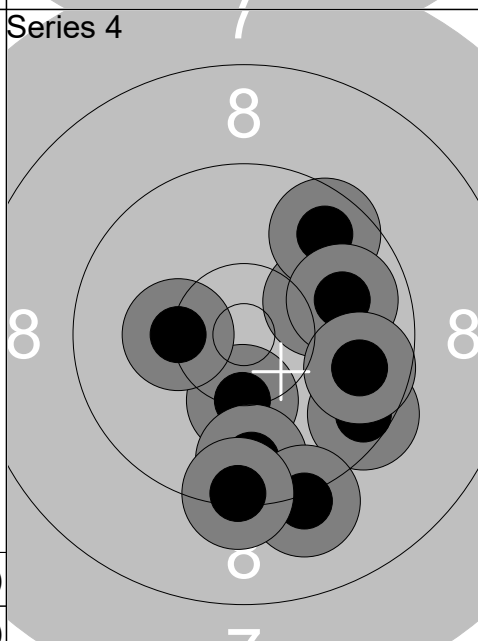

1: 10.1 ↗
2: 10.3 ↓
3: 9.7 ↓
4: 9.6 ↗
5: 9.5 ↘
6: 10.3 ←
7: 9.2 ↓
8: 9.9 →
9: 9.7 →
10: 9.3 ↓
Series 93 (0x)
350 (4x)

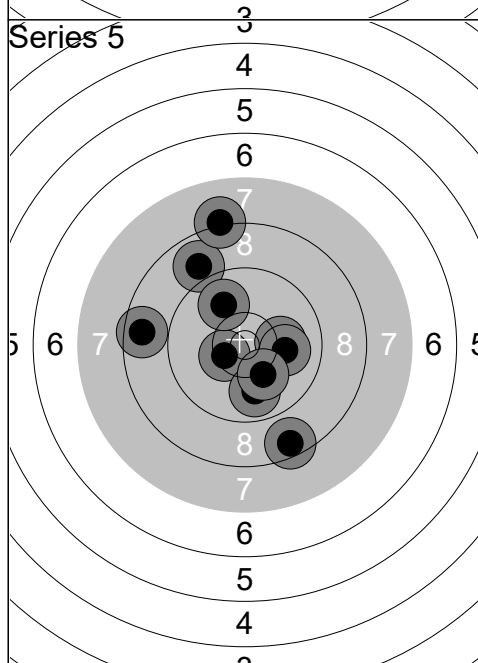

1: 10.4x ↙
2: 10.2 →
3: 8.9 ↗
4: 9.9 ↓
5: 10.0 →
6: 10.2 ↓
7: 9.9 ↗
8: 8.6 ←
9: 8.2 ↑
10: 8.5 ↓
Series 90 (1x)
440 (5x)

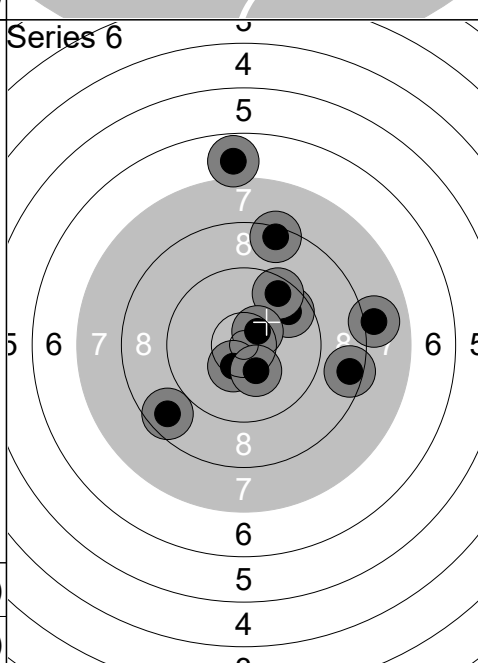

1: 9.7 ↗
2: 9.6 ↗
3: 8.0 →
4: 10.5x ↗
5: 8.5 →
6: 8.4 ↑
7: 10.4x ↓
8: 10.3 ↓
9: 6.8 ↑
10: 8.7 ↙
Series 86 (2x)
526 (7x)

Relay	Lane	Morten Andersen	
1	10		
1 Air	DEN	Mp	Pistol
18.02.2024	Denmark Open Air Day 3	Denmark Open Air 2024	
Series 1 	1: 8.9 ↓	Series 2 	1: 8.9 →
	2: 8.7 →		2: 8.5 ↙
	3: 9.2 ↗		3: 10.3 ↑
	4: 10.4x ↓		4: 8.7 ↙
	5: 8.9 ←		5: 8.4 ↓
	6: 10.2 ↗		6: 9.1 ↗
	7: 9.5 →		7: 9.4 ↗
	8: 9.7 ↘		8: 9.5 ↙
	9: 9.2 ←		9: 10.4x ↑
	10: 10.0 ↗		10: 9.9 ↗
Series 90 (1x)	Series 88 (1x)		
90 (1x)	178 (2x)		
Series 3 	1: 10.0 ←	Series 4 	1: 9.7 ↗
	2: 9.6 ←		2: 9.5 ↘
	3: 10.5x ↙		3: 9.6 ↗
	4: 8.9 ↙		4: 9.3 ←
	5: 9.3 ←		5: 9.7 ↓
	6: 10.6x ↙		6: 8.6 →
	7: 10.1 →		7: 9.4 ↓
	8: 9.9 ↑		8: 10.4x ↓
	9: 8.6 ↘		9: 10.0 ↓
	10: 8.1 ↙		10: 9.9 ↘
Series 91 (2x)	Series 91 (1x)		
269 (4x)	360 (5x)		
Series 5 	1: 10.6x ↙	Series 6 	1: 9.0 →
	2: 9.4 ↑		2: 8.8 →
	3: 10.4x ↙		3: 9.8 →
	4: 8.0 →		4: 9.7 ←
	5: 9.5 ↑		5: 10.0 →
	6: 9.9 ↗		6: 9.1 ↓
	7: 8.6 ↑		7: 9.8 ↓
	8: 10.8x ↑		8: 9.6 ↑
	9: 10.0 ↓		9: 9.1 ↑
	10: 9.9 ↘		10: 9.8 →
Series 92 (3x)	Series 90 (0x)		
452 (8x)	542 (8x)		

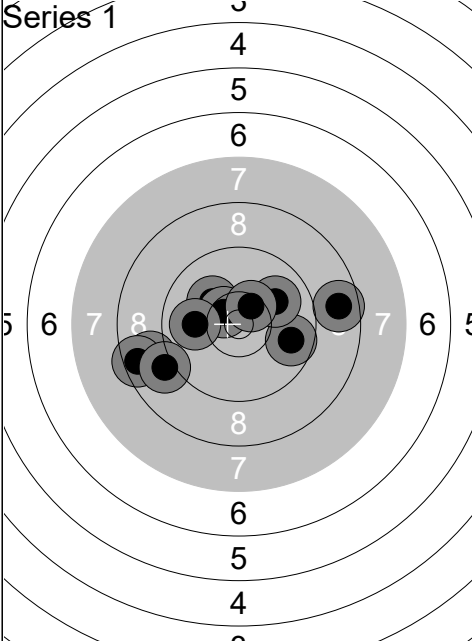
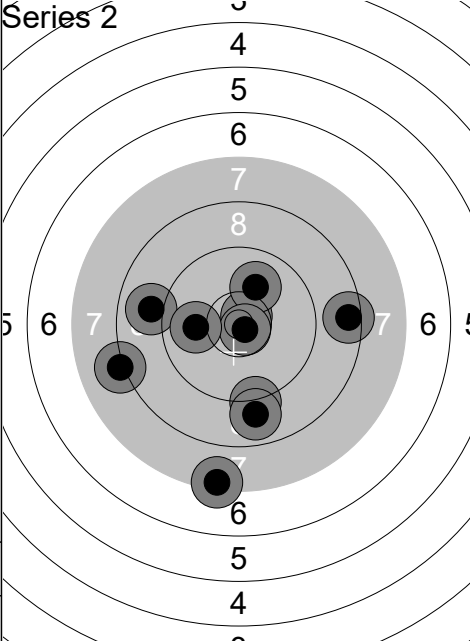
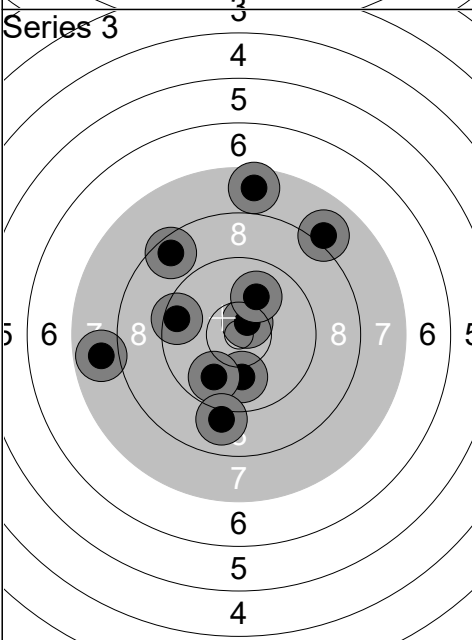
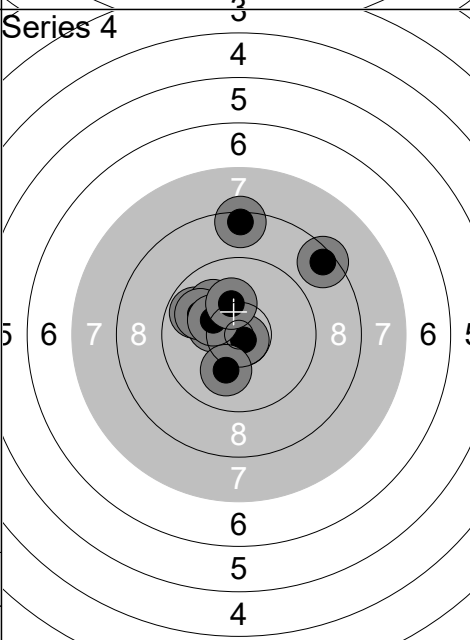
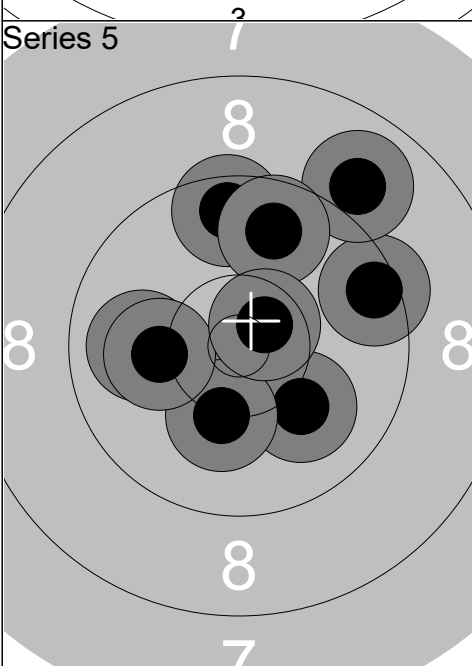
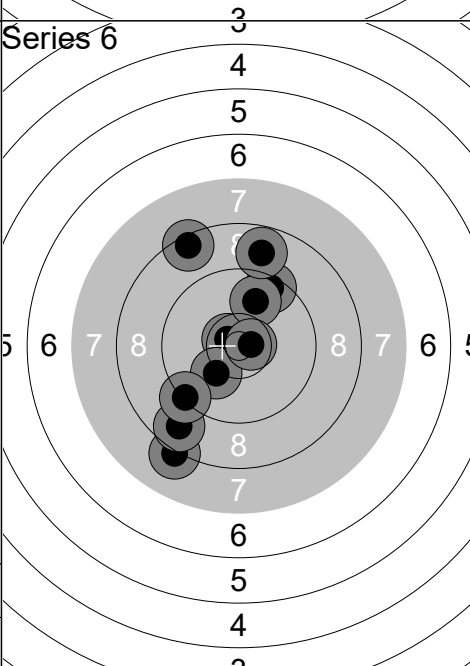
Relay	Lane	Flemming Kristensen		
1	11	DEN	Mp	Pistol
18.02.2024	Denmark Open Air Day 3	Denmark Open Air 2024		
Series 1		1: 9.7 →	Series 2	1: 10.7x ↗
		2: 10.2 ↖		2: 9.2 ↓
		3: 10.5x ↖		3: 8.1 ←
		4: 10.0 ←		4: 7.4 ↓
		5: 8.8 ←		5: 9.0 ←
		6: 8.5 ←		6: 10.0 ↗
		7: 8.7 →		7: 10.8x ↘
		8: 10.0 ↗		8: 10.0 ←
		9: 10.5x ↗		9: 8.9 ↓
		10: 9.0 ←		10: 8.5 →
		Series 92 (2x)		Series 89 (2x)
		92 (2x)		181 (4x)
Series 3		1: 8.6 ↖	Series 4	1: 8.4 ↑
		2: 10.0 ↓		2: 10.3 ←
		3: 7.7 ↑		3: 9.9 ←
		4: 9.5 ←		4: 10.1 ↖
		5: 9.9 ↓		5: 10.8x ↘
		6: 8.0 ↗		6: 8.5 ↗
		7: 10.6x ↗		7: 10.0 ←
		8: 9.0 ↓		8: 10.3 ←
		9: 10.0 ↗		9: 10.2 ↑
		10: 7.8 ←		10: 10.1 ↓
		Series 87 (1x)		Series 95 (1x)
		268 (5x)		363 (6x)
Series 5		1: 10.0 ←	Series 6	1: 10.6x ↖
		2: 9.6 ↑		2: 8.2 ↓
		3: 10.7x ↘		3: 9.5 ↗
		4: 9.5 →		4: 8.4 ↖
		5: 8.9 ↗		5: 10.1 ↘
		6: 10.1 ↘		6: 9.9 ↗
		7: 9.7 ↗		7: 8.8 ↑
		8: 10.2 ↓		8: 8.7 ↓
		9: 10.1 ←		9: 10.7x →
		10: 10.6x ↗		10: 9.3 ↓
		Series 95 (2x)		Series 89 (2x)
		458 (8x)		547 (10x)

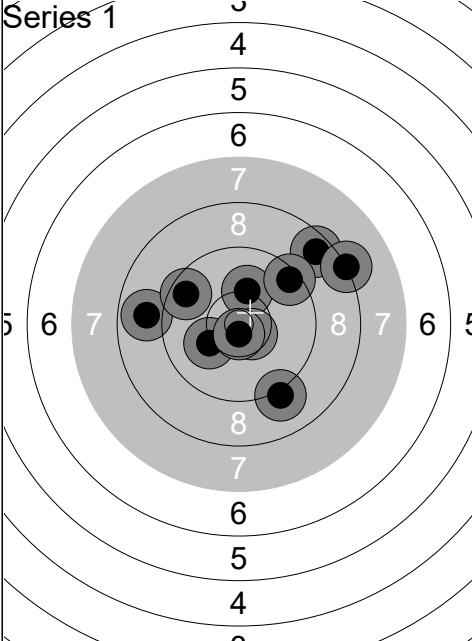
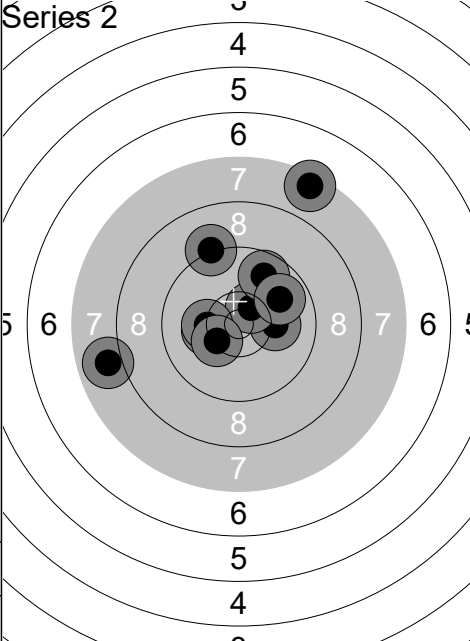
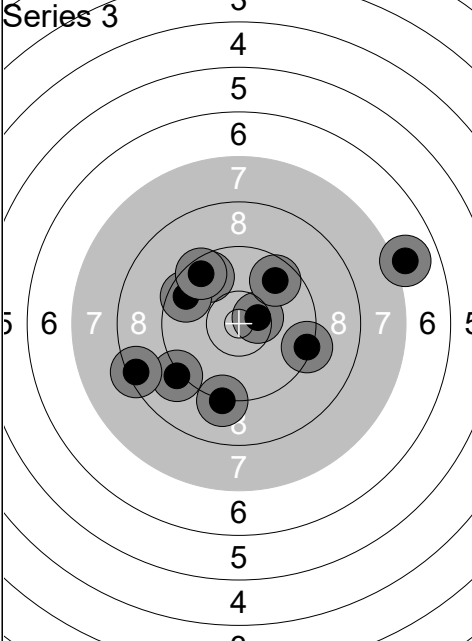
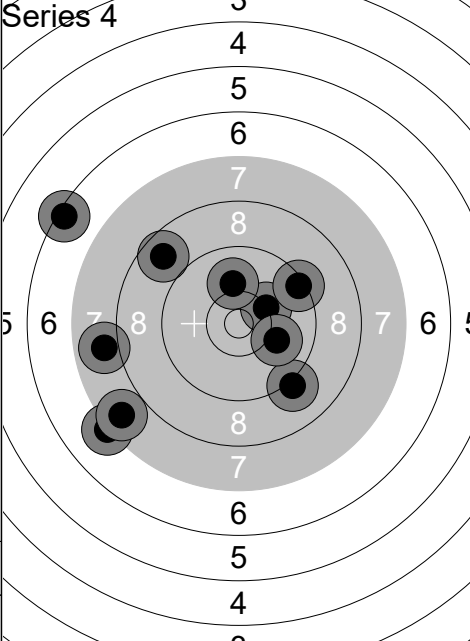
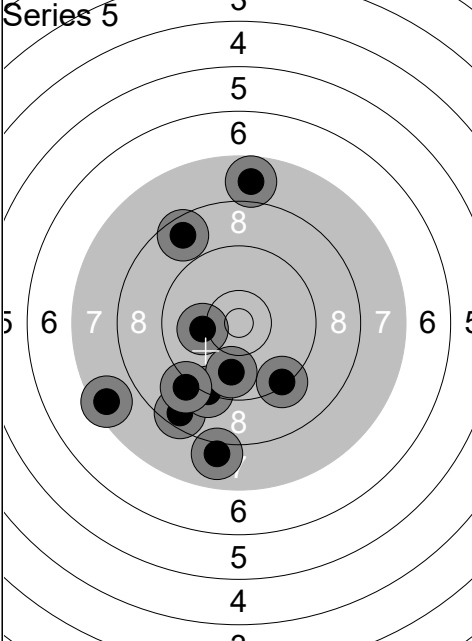
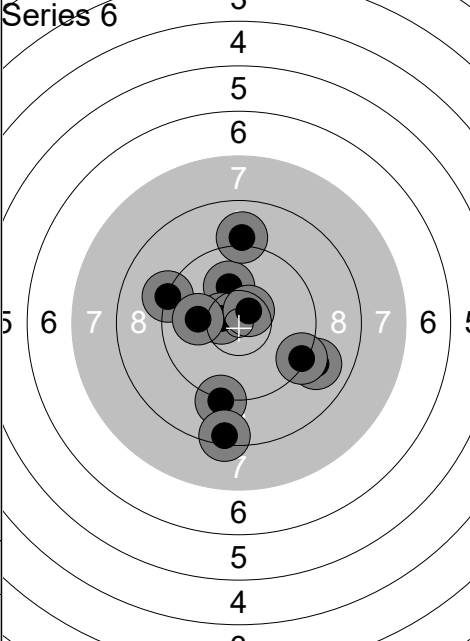
Relay	Lane	Stefan Nielsen			
1	12	DEN	Mp	Pistol	
18.02.2024	Denmark Open Air Day 3	Denmark Open Air 2024			
Series 1		1: 10.2 ↑	Series 2		1: 9.2 ↗
		2: 8.6 ↗			2: 10.1 →
		3: 10.6x ↘			3: 10.5x ↗
		4: 8.9 ←			4: 7.9 ←
		5: 10.2 ←			5: 7.5 ↗
		6: 9.1 ↘			6: 9.7 ↗
		7: 8.2 ↗			7: 9.9 ↗
		8: 9.4 ↗			8: 10.2 ←
		9: 10.7x ↓			9: 10.2 ←
		10: 9.6 ↖			10: 10.3 ↘
		Series 91 (2x)			Series 91 (1x)
		91 (2x)			182 (3x)
Series 3		1: 9.3 →	Series 4		1: 10.2 ↗
		2: 7.0 →			2: 9.1 ↘
		3: 9.7 ↗			3: 6.4 ↖
		4: 9.2 ↓			4: 10.0 ↑
		5: 9.6 ↖			5: 8.7 ↖
		6: 9.1 ↖			6: 7.2 ↖
		7: 8.4 ←			7: 7.9 ←
		8: 9.5 ↗			8: 9.4 ↗
		9: 10.5x →			9: 7.6 ↖
		10: 9.7 ↗			10: 10.0 →
		Series 88 (1x)			Series 83 (0x)
		270 (4x)			353 (4x)
Series 5		1: 9.3 ↘	Series 6		1: 10.1 ↑
		2: 10.1 ←			2: 9.0 ↑
		3: 8.5 ↘			3: 9.0 →
		4: 8.6 ↗			4: 9.2 ↓
		5: 9.3 ↘			5: 9.2 ↖
		6: 9.8 ↓			6: 10.5x ↖
		7: 8.0 ↓			7: 10.0 ←
		8: 9.1 ↘			8: 8.4 ↓
		9: 7.5 ←			9: 10.6x ↗
		10: 7.8 ↑			10: 9.3 →
		Series 84 (0x)			Series 93 (2x)
		437 (4x)			530 (6x)

Relay	Lane	Amine Adjabi		
1 Air	15	ALG	Mp	Pistol
18.02.2024	Denmark Open Air Day 3		Denmark Open Air 2024	
Series 1 	1: 9.1 ←	Series 2 	1: 10.0 ↓	
	2: 9.9 →		2: 9.8 ↓	
	3: 10.2 ↗		3: 9.4 ↗	
	4: 8.8 ←		4: 10.1 ↗	
	5: 10.3 →		5: 9.9 ↓	
	6: 10.8x ↓		6: 10.8x ←	
	7: 10.5x ↗		7: 10.1 ←	
	8: 9.1 ←		8: 8.8 ↓	
	9: 10.6x ↓		9: 10.2 →	
	10: 9.7 ↖		10: 9.8 ↖	
	Series 94 (3x)		Series 94 (1x)	
	94 (3x)		188 (4x)	
Series 3 	1: 10.5x ↓	Series 4 	1: 9.4 ↑	
	2: 9.8 ↖		2: 9.7 ↓	
	3: 9.9 ↗		3: 10.6x ←	
	4: 10.0 ↓		4: 9.6 ↓	
	5: 10.8x ↖		5: 9.8 ↑	
	6: 10.4x ↓		6: 9.9 ↖	
	7: 9.7 ↖		7: 10.0 ↖	
	8: 10.5x ↓		8: 9.8 ↖	
	9: 9.8 ↓		9: 10.8x ↖	
	10: 10.5x ↑		10: 10.4x ←	
	Series 96 (5x)		Series 94 (3x)	
	284 (9x)		378 (12x)	
Series 5 	1: 9.7 ↑	Series 6 	1: 10.0 →	
	2: 9.4 ↗		2: 9.7 ↖	
	3: 9.4 ↗		3: 9.7 ↓	
	4: 9.7 ←		4: 10.4x ↖	
	5: 10.5x ↖		5: 10.0 →	
	6: 10.7x ↑		6: 10.2 →	
	7: 8.9 ↓		7: 10.6x ↑	
	8: 10.4x ↖		8: 10.6x ↑	
	9: 10.5x →		9: 8.8 →	
	10: 9.6 ↓		10: 10.1 ↗	
	Series 93 (4x)		Series 96 (3x)	
	471 (16x)		567 (19x)	

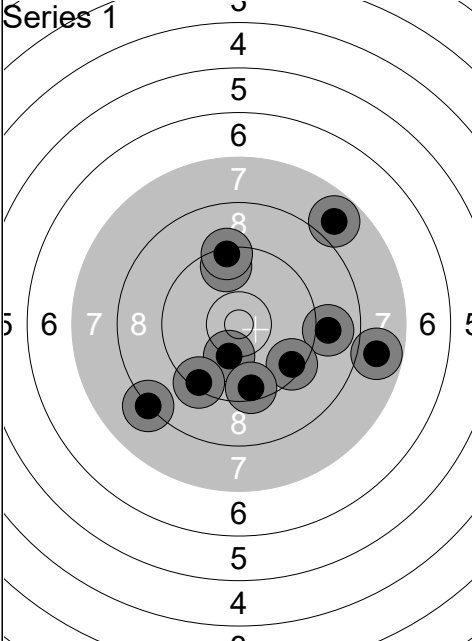
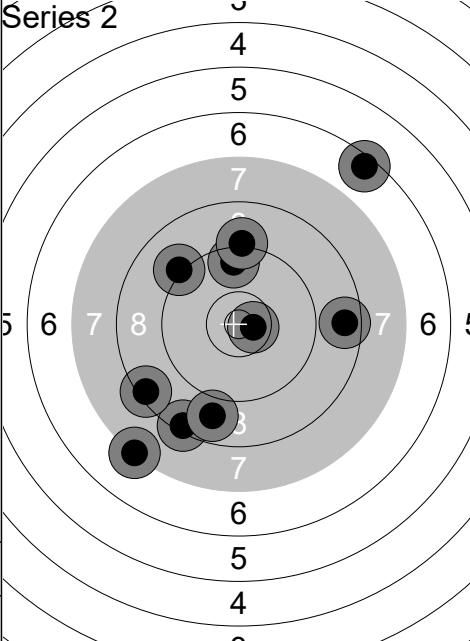
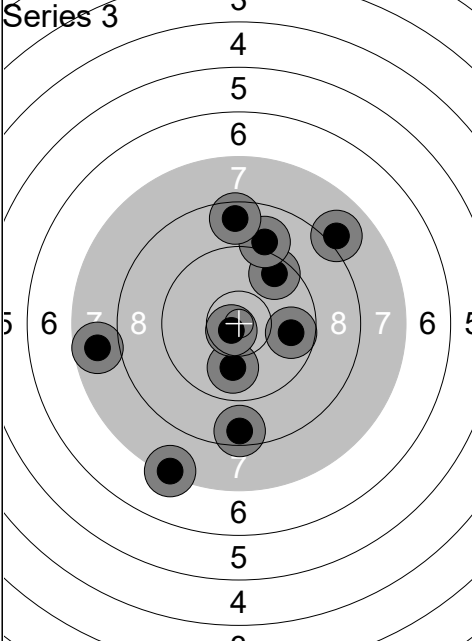
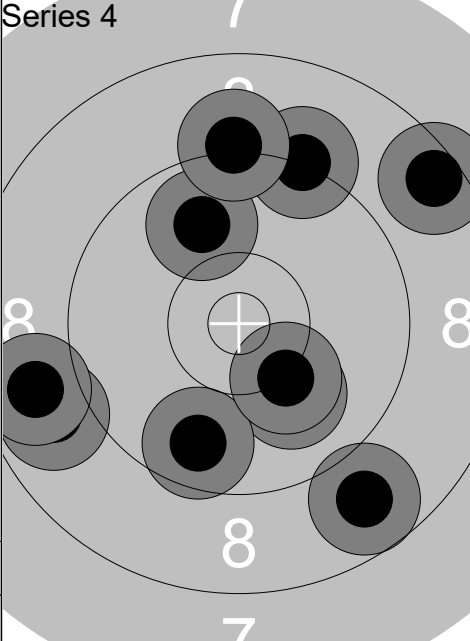
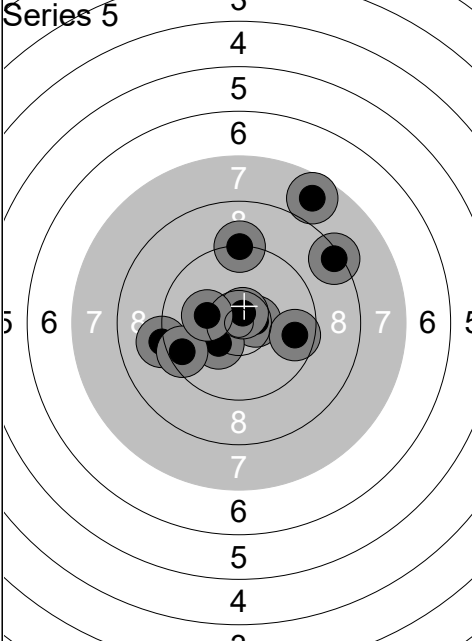
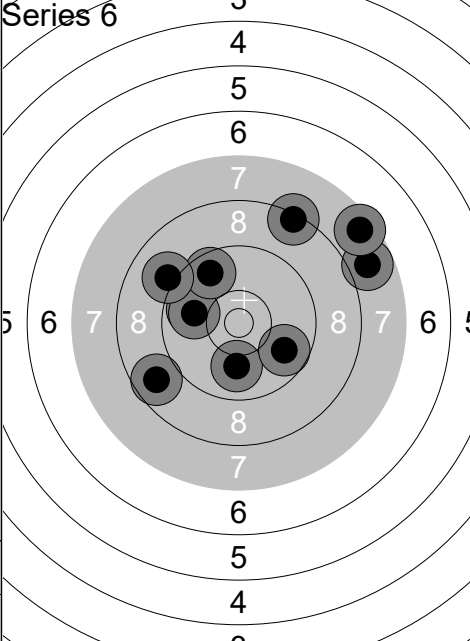
Relay	Lane	Patrick Larsson			
1	17	SWE	Mp	Pistol	
18.02.2024	Denmark Open Air Day 3	Denmark Open Air 2024			
Series 1		1: 10.2 ↓	Series 2		1: 8.4 ↓
		2: 8.2 ↙			2: 9.5 ↑
		3: 9.6 ↑			3: 10.6x →
		4: 7.8 ↗			4: 8.4 ↙
		5: 8.9 →			5: 9.1 ↗
		6: 9.4 ↙			6: 8.6 →
		7: 9.5 ↘			7: 8.8 ↓
		8: 9.3 ↑			8: 9.1 ↑
		9: 7.8 →			9: 7.3 ↙
		10: 9.5 ↓			10: 6.5 ↗
		Series 85 (0x)			Series 82 (1x)
		85 (0x)			167 (1x)
Series 3		1: 7.3 ↓	Series 4		1: 9.2 ↑
		2: 9.6 ↗			2: 10.1 ↘
		3: 10.0 ↓			3: 9.7 ↓
		4: 9.0 ↑			4: 8.5 ↗
		5: 8.6 ↓			5: 8.8 ↘
		6: 8.6 ↑			6: 9.9 ↑
		7: 8.0 ↗			7: 10.2 ↘
		8: 9.8 →			8: 9.1 ↑
		9: 7.7 ←			9: 8.9 ←
		10: 10.7x ↙			10: 8.8 ←
		Series 85 (1x)			Series 88 (0x)
		252 (2x)			340 (2x)
Series 5		1: 9.2 ↑	Series 6		1: 7.8 ↗
		2: 10.6x →			2: 9.9 ←
		3: 9.2 ←			3: 9.9 ←
		4: 10.3 ↙			4: 10.0 ↓
		5: 10.7x ↑			5: 8.3 ↑
		6: 9.5 ←			6: 9.8 ↘
		7: 9.7 →			7: 9.7 ↗
		8: 7.7 ↗			8: 9.1 ↗
		9: 8.4 ↗			9: 7.5 ↗
		10: 10.2 ←			10: 8.7 ↙
		Series 91 (2x)			Series 85 (0x)
		431 (4x)			516 (4x)

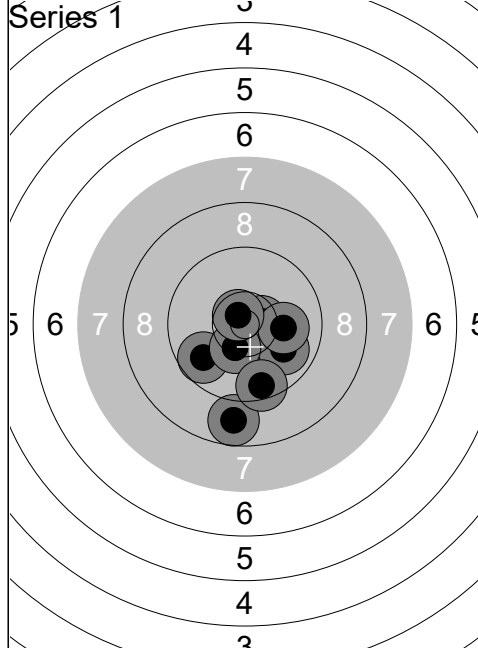

1:	10.5x	➔
2:	10.6x	➔
3:	8.8	↓
4:	10.5x	↓
5:	9.9	➔
6:	10.1	➔
7:	9.8	↙
8:	10.4x	↓
9:	9.5	↓
10:	10.7x	↖
Series		95 (5x)
		95 (5x)

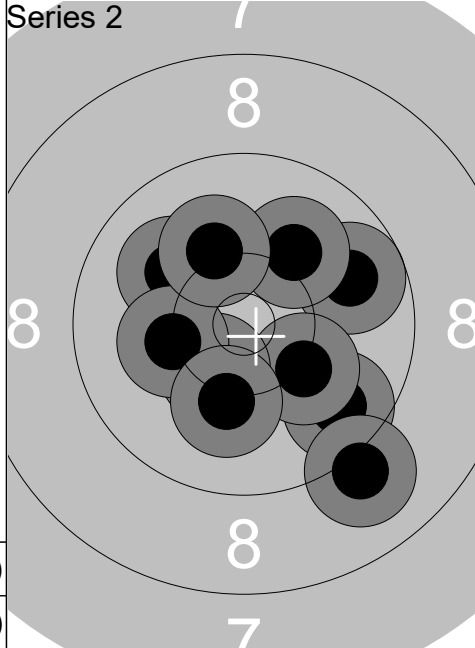

1:	9.8	➔
2:	10.1	↗
3:	9.7	↘
4:	10.2	↘
5:	10.1	↖
6:	10.4x	↘
7:	10.2	←
8:	9.1	↘
9:	10.2	↓
10:	10.1	↗
Series		97 (1x)
		192 (6x)

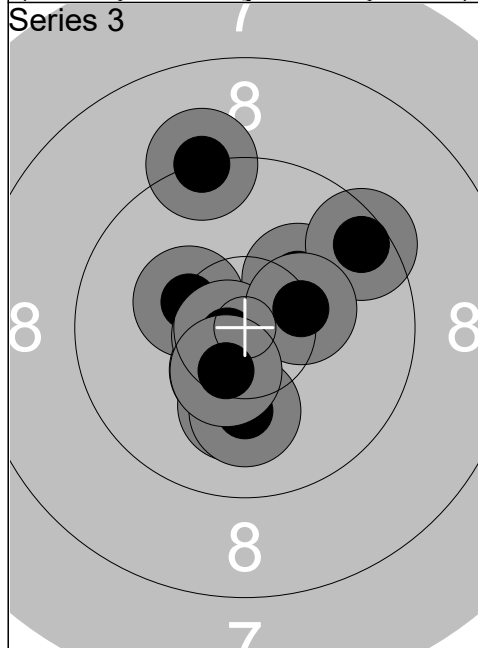

1:	10.3	↖
2:	9.2	↗
3:	10.5x	↘
4:	10.2	↗
5:	9.5	↗
6:	10.8x	↙
7:	10.4	➔
8:	10.1	↓
9:	10.1	↓
10:	10.5x	↘
Series		98 (3x)
		290 (9x)

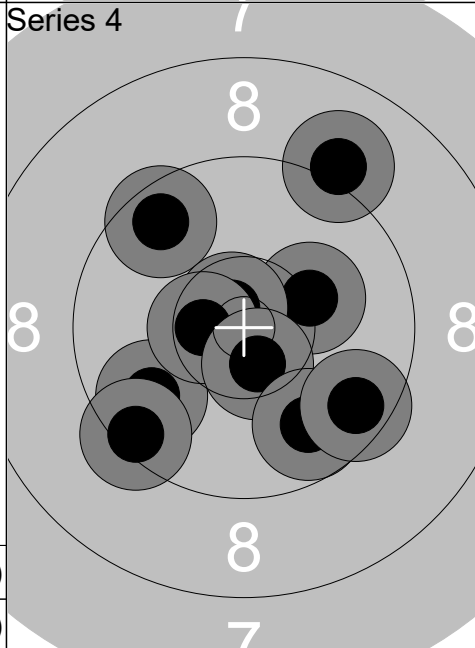

1:	9.8	↙
2:	9.4	↙
3:	9.6	↖
4:	10.2	➔
5:	9.1	↗
6:	10.7x	↖
7:	10.5x	↙
8:	10.6x	↓
9:	9.8	↘
10:	9.6	↘
Series		94 (3x)
		384 (12x)

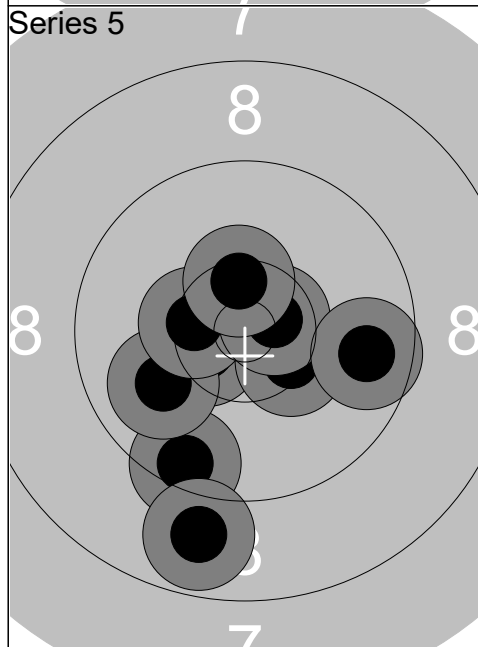

1:	10.5x	↙
2:	10.7x	↖
3:	10.4x	➔
4:	9.5	↓
5:	10.0	↙
6:	10.4x	↙
7:	10.6x	➔
8:	9.7	➔
9:	10.4x	↗
10:	8.8	↓
Series		96 (6x)
		480 (18x)

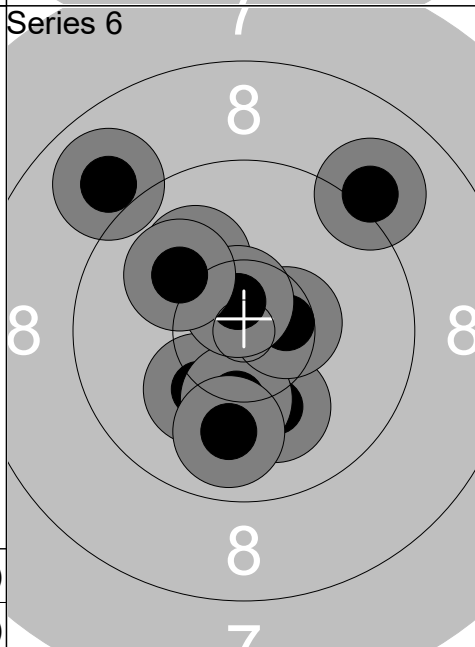

1:	10.1	↓
2:	10.1	↖
3:	9.1	↗
4:	10.2	↘
5:	10.3	↓
6:	10.5x	➔
7:	10.6x	↗
8:	10.1	↖
9:	8.9	↖
10:	9.9	↓
Series		96 (2x)
		576 (20x)

Relay	Lane	Kaj Lund		
1 Air	DEN	Mp	Pistol	
18.02.2024	Denmark Open Air Day 3	Denmark Open Air 2024		
Series 1 	1: 8.7 ←	Series 2 	1: 7.5 ↙	
	2: 9.2 ↓		2: 8.2 ↓	
	3: 8.7 ↓		3: 8.0 ↙	
4: 8.8 ↓	4: 8.8 →	4: 8.8 →		
5: 9.5 ↓	5: 10.5x ↘	5: 10.5x ↘		
6: 8.3 ↙	6: 10.0 ↗	6: 10.0 ↗		
7: 8.9 ↑	7: 9.5 →	7: 9.5 →		
8: 6.8 ←	8: 9.3 →	8: 9.3 →		
9: 1.2 ←	9: 7.4 ↙	9: 7.4 ↙		
10: 8.8 ↑	10: 9.6 →	10: 9.6 →		
Series 73 (0x)	Series 85 (1x)			
73 (0x)	158 (1x)			
Series 3 	1: 9.0 ↓	Series 4 	1: 6.9 ←	
	2: 9.9 →		2: 9.9 →	
	3: 9.0 ←		3: 8.6 ↗	
4: 7.9 ←	4: 6.4 ←	4: 6.4 ←		
5: 4.4 ←	5: 10.1 ↗	5: 10.1 ↗		
6: 10.4 ←	6: 6.1 ↗	6: 6.1 ↗		
7: 8.4 ←	7: 8.1 ↑	7: 8.1 ↑		
8: 9.5 ↑	8: 6.5 ←	8: 6.5 ←		
9: 5.5 ←	9: 10.4x ↘	9: 10.4x ↘		
10: 8.6 ←	10: 5.9 ↗	10: 5.9 ↗		
Series 78 (0x)	Series 74 (1x)			
236 (1x)	310 (2x)			
Series 5 	1: 9.6 ↗	Series 6 	1: 8.0 ↓	
	2: 9.5 →		2: 10.2 ↗	
	3: 10.4x ↘		3: 9.8 ←	
4: 8.4 ←	4: 8.8 ↗	4: 8.8 ↗		
5: 8.1 ↗	5: 8.1 ←	5: 8.1 ←		
6: 8.8 ←	6: 6.2 →	6: 6.2 →		
7: 5.4 →	7: 9.6 ↓	7: 9.6 ↓		
8: 9.7 ↗	8: 9.7 ↗	8: 9.7 ↗		
9: 10.4x ↘	9: 7.8 ↙	9: 7.8 ↙		
10: 9.9 ←	10: 7.5 ↙	10: 7.5 ↙		
Series 85 (2x)	Series 81 (0x)			
395 (4x)	476 (4x)			

Relay	Lane	Emil Strandgaard			
1	20	DEN		Mp	Pistol
18.02.2024		Denmark Open Air Day 3		Denmark Open Air 2024	
Series 1 	1: 10.4x ↗	Series 2 	1: 9.3 ↗		
	2: 10.7x ↘		2: 9.9 ↘		
	3: 10.0 ↘		3: 9.9 ↖		
	4: 10.7x ↗		4: 9.2 ↑		
	5: 10.8x ↙		5: 10.2 ↘		
	6: 9.2 ↑		6: 9.6 ←		
	7: 9.1 ↘		7: 10.1 ↗		
	8: 10.2 ↑		8: 9.0 →		
	9: 10.4x ↑		9: 8.2 ↘		
	10: 10.7x ↑		10: 9.9 →		
	Series 98 (6x)		Series 91 (0x)		
	98 (6x)		189 (6x)		
Series 3 	1: 8.8 ←	Series 4 	1: 8.4 ↗		
	2: 10.0 ↗		2: 10.2 →		
	3: 8.9 ↑		3: 9.8 ←		
	4: 9.2 ↘		4: 9.2 ←		
	5: 9.6 ↑		5: 9.1 ↗		
	6: 10.6x ↑		6: 10.1 ←		
	7: 9.6 ←		7: 10.2 ←		
	8: 10.4x ↙		8: 10.0 ↗		
	9: 10.6x ↙		9: 10.3 ↑		
	10: 10.3 ↘		10: 10.6x →		
	Series 93 (3x)		Series 95 (1x)		
	282 (9x)		377 (10x)		
Series 5 	1: 9.8 ↘	Series 6 	1: 10.5x ↘		
	2: 9.6 →		2: 7.5 →		
	3: 9.5 ←		3: 9.2 →		
	4: 10.8x ↙		4: 9.6 ↘		
	5: 10.4x ↙		5: 9.0 ↘		
	6: 10.3 ↘		6: 10.7x ↑		
	7: 10.5x ↘		7: 10.2 →		
	8: 8.9 ↘		8: 9.4 ↘		
	9: 9.0 ↑		9: 9.6 →		
	10: 10.3 ↗		10: 8.7 ↘		
	Series 94 (3x)		Series 90 (2x)		
	471 (13x)		561 (15x)		

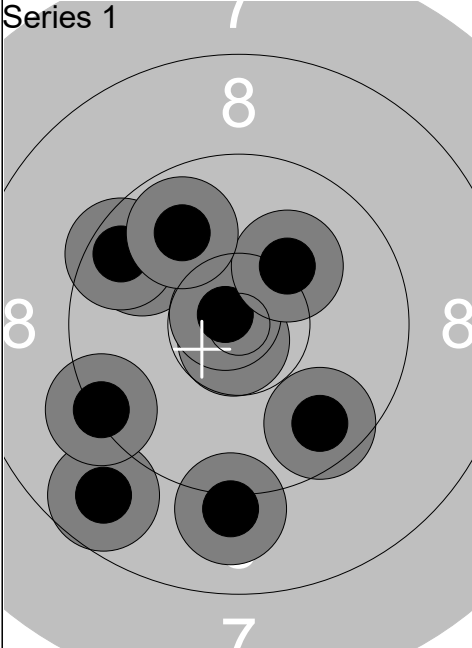
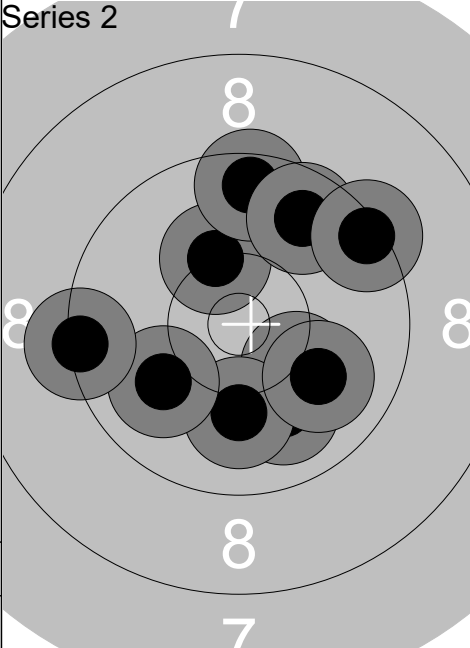
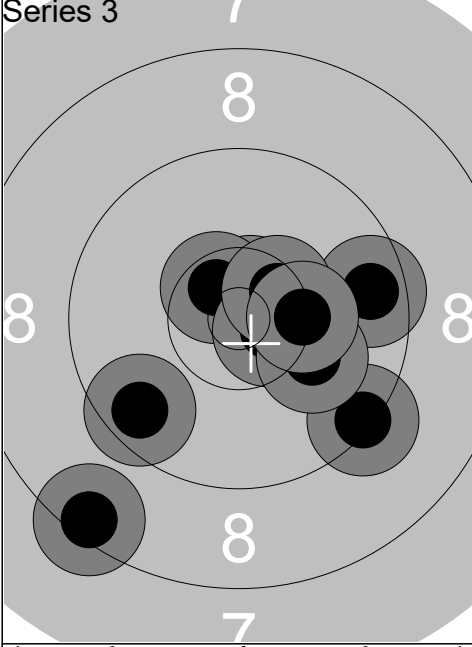
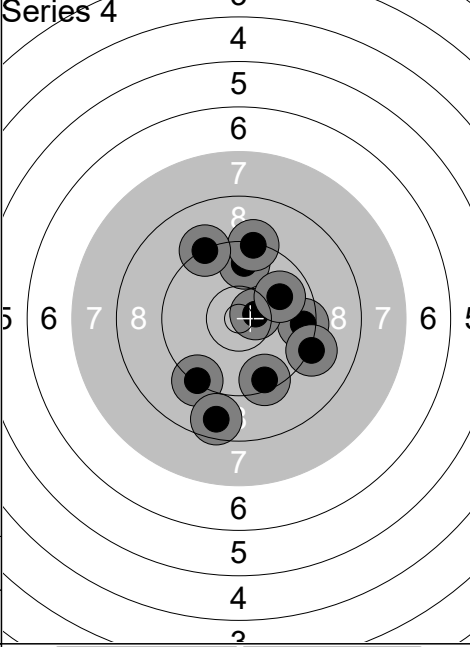
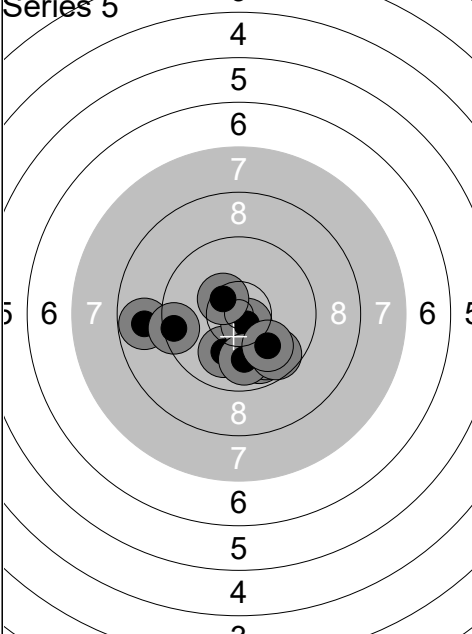
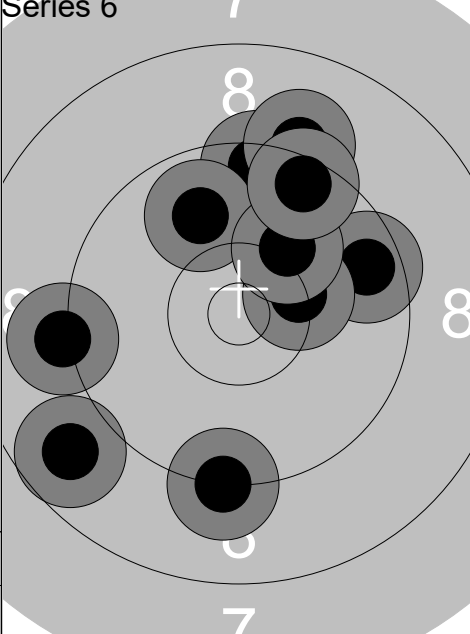
Relay	Lane	Anders Kruse Christensen			
1 Air	DEN	Mp	Pistol		
18.02.2024	Denmark Open Air Day 3	Denmark Open Air 2024			
Series 1		1: 10.8x ↓	Series 2		1: 10.0 ↓
		2: 8.7 ↓			2: 10.2 ↘
		3: 9.7 ↓		3: 10.1 ↓	
		4: 9.8 ↖		4: 10.2 ↗	
		5: 10.8x ↖		5: 9.5 ↑	
		6: 10.2 ↗		6: 9.7 ↗	
		7: 9.3 ↖		7: 10.0 ↖	
		8: 9.6 ↖		8: 9.3 ←	
		9: 9.9 ↗		9: 10.0 ↘	
		10: 9.1 ↓		10: 9.4 ↗	
	Series	92 (2x)		Series	96 (0x)
		92 (2x)			188 (2x)
Series 3		1: 9.6 ↖	Series 4		1: 9.3 ↖
		2: 8.4 ↓			2: 9.5 →
		3: 10.6x ↗		3: 9.7 ↑	
		4: 10.6x ↖		4: 10.6x →	
		5: 9.6 →		5: 9.2 ↘	
		6: 10.6x ↘		6: 8.6 ↓	
		7: 9.3 ↖		7: 9.3 ↑	
		8: 10.1 ↘		8: 9.2 ↖	
		9: 10.5x ↗		9: 9.9 ↗	
		10: 10.3 →		10: 9.5 ↓	
	Series	95 (4x)		Series	90 (1x)
		283 (6x)			373 (7x)
Series 5		1: 10.0 ↓	Series 6		1: 9.4 ↑
		2: 10.7x ↓			2: 9.2 ↓
		3: 9.9 ↓		3: 9.6 →	
		4: 9.9 ↓		4: 8.7 ↖	
		5: 8.8 ←		5: 10.3 →	
		6: 10.5x ↗		6: 9.1 ↑	
		7: 9.9 ↓		7: 9.9 ↖	
		8: 9.5 ←		8: 9.2 ←	
		9: 9.7 ↓		9: 10.1 ↗	
		10: 10.0 ↓		10: 9.5 ↖	
	Series	93 (2x)		Series	91 (0x)
		466 (9x)			557 (9x)

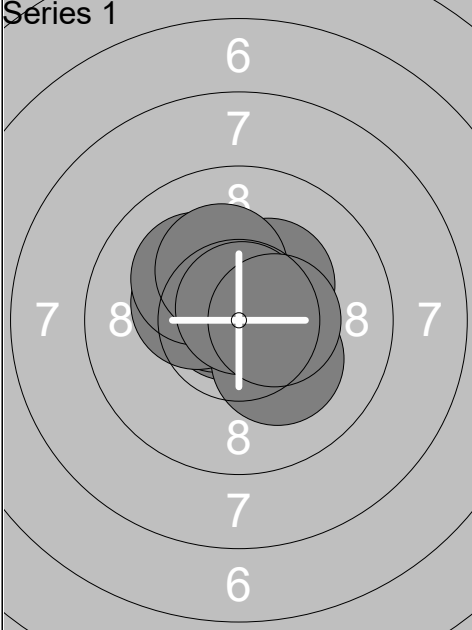
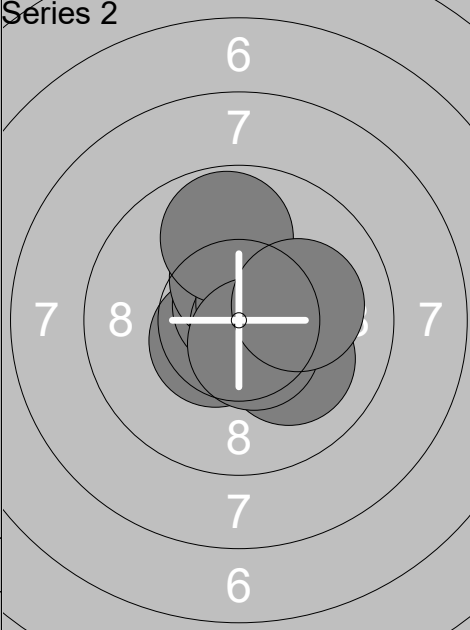
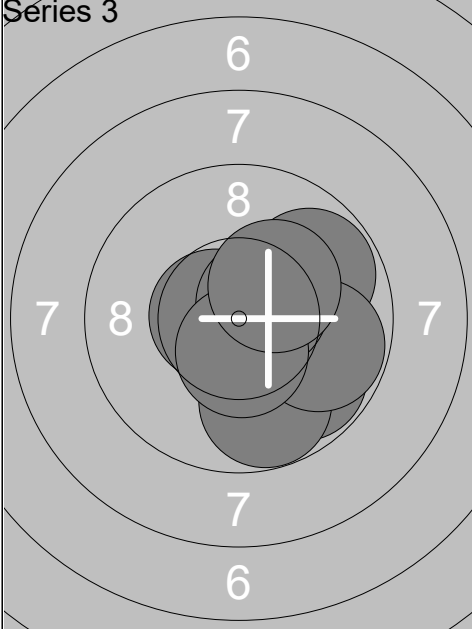
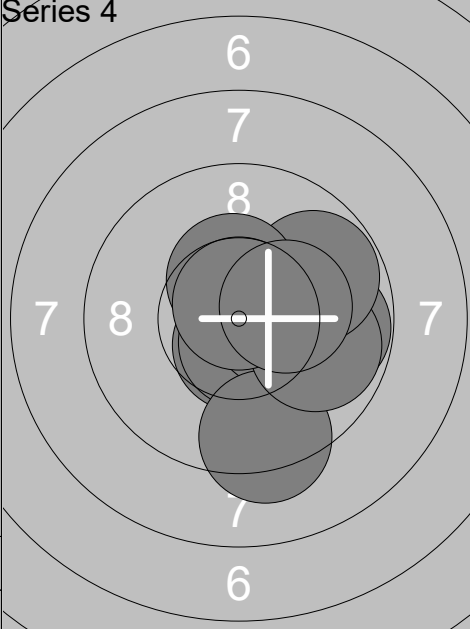
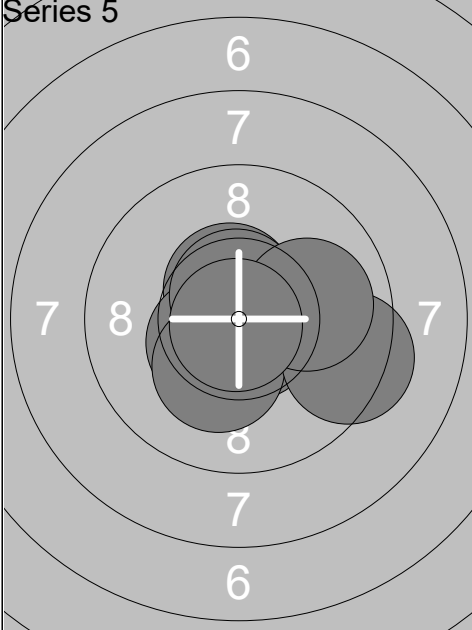
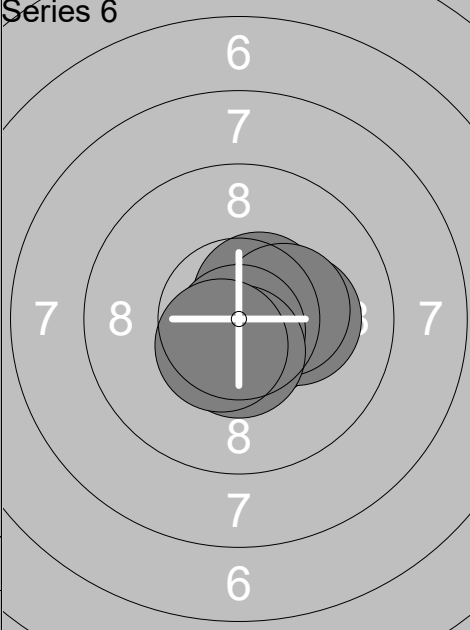
Relay	Lane	Anton Salomonsson		
1	23	SWE	MJ	Rifle
18.02.2024	Denmark Open Air Day 3	Denmark Open Air 2024		
Series 1 	1: 10.3x ↗	Series 2 	1: 10.5x ↙	
	2: 10.7x →		2: 10.2x →	
	3: 10.8x ↖		3: 10.1 ↘	
	4: 10.6x ↖		4: 10.7x ↑	
	5: 10.2x ↘		5: 10.4x ↑	
	6: 10.3x ↖		6: 10.7x →	
	7: 10.1 ↗		7: 10.5x ↗	
	8: 10.2x ↑		8: 9.8 ↑	
	9: 10.8x ↑		9: 10.6x ↘	
	10: 10.5x →		10: 10.1 →	
	Series 100.0		Series 99.0	
	100.0		199.0	
Series 3 	1: 10.8x ↓	Series 4 	1: 10.6x ↓	
	2: 9.8 ↗		2: 10.6x ↓	
	3: 9.8 ↘		3: 9.8 →	
	4: 10.2x ↓		4: 10.4x →	
	5: 9.8 ↓		5: 9.3 ↓	
	6: 9.8 →		6: 9.8 →	
	7: 10.6x ←		7: 9.8 ↗	
	8: 10.5x ↗		8: 10.4x ↑	
	9: 10.5x ↓		9: 10.7x ↑	
	10: 10.3x ↗		10: 10.3x →	
	Series 96.0		Series 96.0	
	295.0		391.0	
Series 5 	1: 10.4x ↓	Series 6 	1: 10.6x ↘	
	2: 10.5x ↑		2: 10.6x ↗	
	3: 10.4x ↙		3: 10.5x →	
	4: 10.7x ↓		4: 10.2x →	
	5: 10.6x ↑		5: 10.5x ↓	
	6: 10.7x ↘		6: 10.5x ↗	
	7: 10.2x ↓		7: 10.3x →	
	8: 9.3 →		8: 10.8x ↓	
	9: 10.0 →		9: 10.5x ↓	
	10: 10.8x ↓		10: 10.5x ↙	
	Series 99.0		Series 100.0	
	490.0		590.0	

Relay	Lane	Axel Löfvander		
1 Air	24	SWE	MJ	Rifle
18.02.2024	Denmark Open Air Day 3	Denmark Open Air 2024		
Series 1 	1: 9.4 ↖	Series 2 	1: 10.1 ↖	
	2: 10.7x →		2: 10.5x ↑	
	3: 10.1 ↓		3: 10.8x ↓	
	4: 10.6x ↗		4: 9.9 ←	
	5: 10.6x ↖		5: 10.6x ↓	
	6: 10.3x →		6: 10.0 ↘	
	7: 10.5x ↑		7: 10.7x ↑	
	8: 9.8 ↗		8: 10.9x ↘	
	9: 9.9 ↑		9: 10.2x ↖	
	10: 10.5x ↙		10: 10.3x →	
	Series 97.0	Series 99.0		
	97.0		196.0	
Series 3 	1: 10.8x →	Series 4 	1: 10.1 ←	
	2: 10.5x ↗		2: 10.5x ↘	
	3: 10.4x ↙		3: 10.3x ↓	
	4: 9.5 ↘		4: 10.5x ↑	
	5: 10.7x ↗		5: 10.2x ↓	
	6: 10.1 ↑		6: 10.7x ↖	
	7: 10.3x →		7: 10.4x ↖	
	8: 9.6 →		8: 10.5x ↓	
	9: 10.5x →		9: 9.7 →	
	10: 10.1 →		10: 10.6x ↘	
	Series 98.0	Series 99.0		
	294.0		393.0	
Series 5 	1: 10.6x →	Series 6 	1: 10.6x ↓	
	2: 9.7 ↓		2: 10.2x ↙	
	3: 10.3x →		3: 10.8x ↑	
	4: 10.6x ↗		4: 10.2x ↖	
	5: 9.9 ↑		5: 10.3x ↗	
	6: 10.3x ↘		6: 10.0 ↑	
	7: 10.1 ↑		7: 10.3x ↘	
	8: 10.5x ↑		8: 9.8 ↗	
	9: 10.7x ↓		9: 9.7 ↓	
	10: 9.9 ↑		10: 10.8x ↗	
	Series 97.0	Series 98.0		
	490.0		588.0	

Relay	Lane	Matias Ligaard		
1 Air	25	DEN	MJ	Rifle
18.02.2024	Denmark Open Air Day 3		Denmark Open Air 2024	
Series 1 	1: 9.9 ←	Series 2 	1: 10.6x ↑	
	2: 10.9x ↑		2: 9.8 ➤	
	3: 10.0 ←		3: 10.5x ←	
	4: 9.6 ➤		4: 10.3x ↙	
	5: 9.8 ↑		5: 10.3x ↓	
	6: 10.3x ↑		6: 10.4x ↗	
	7: 10.4x ↗		7: 9.9 ↖	
	8: 9.0 ←		8: 10.4x ↑	
	9: 10.6x ↗		9: 10.5x ↓	
	10: 10.7x ➤		10: 10.2x ➤	
	Series 96.0		Series 98.0	
	96.0		194.0	
Series 3 	1: 10.2x ↗	Series 4 	1: 10.6x ↖	
	2: 10.5x ↓		2: 10.2x ↖	
	3: 10.3x ↑		3: 10.6x ↗	
	4: 10.4x ➤		4: 10.6x ↓	
	5: 9.9 ←		5: 9.0 ←	
	6: 9.7 ➤		6: 10.5x ↓	
	7: 10.6x ↓		7: 10.3x ↖	
	8: 10.1 ➤		8: 10.4x ➤	
	9: 10.4x ↓		9: 10.0 ↓	
	10: 9.8 ←		10: 9.4 ➤	
	Series 97.0		Series 98.0	
	291.0		389.0	
Series 5 	1: 10.2x ↗	Series 6 	1: 9.3 ←	
	2: 10.3x ↑		2: 10.5x ↙	
	3: 10.6x ↗		3: 9.7 ↓	
	4: 10.4x ↖		4: 10.5x ←	
	5: 10.9x		5: 9.8 ➤	
	6: 10.3x ↖		6: 10.0 ↓	
	7: 10.6x ↓		7: 10.1 ➤	
	8: 10.4x ↙		8: 9.8 ➤	
	9: 10.4x ↙		9: 9.8 ←	
	10: 10.0 ➤		10: 10.2x ➤	
	Series 100.0		Series 95.0	
	489.0		584.0	

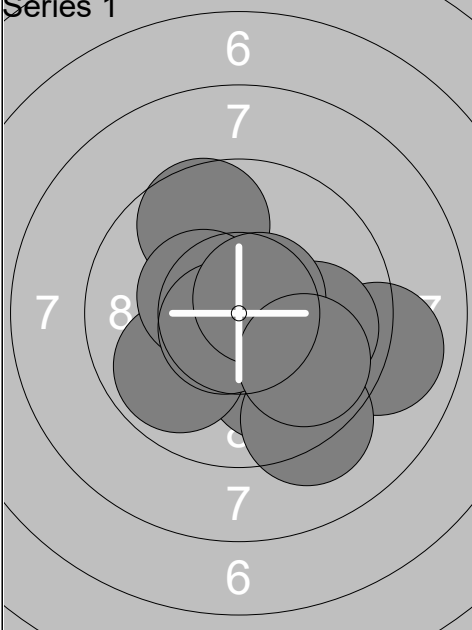
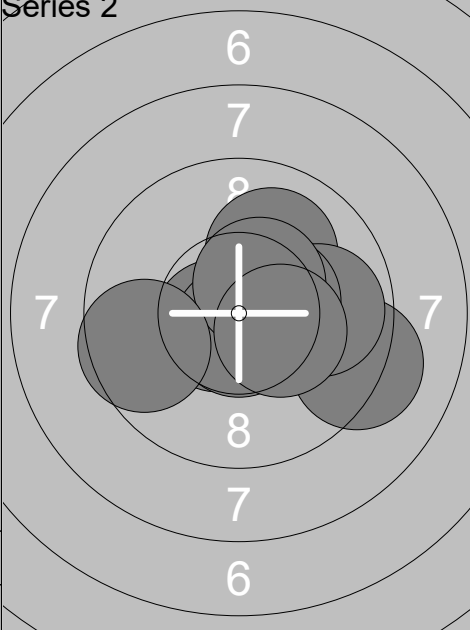
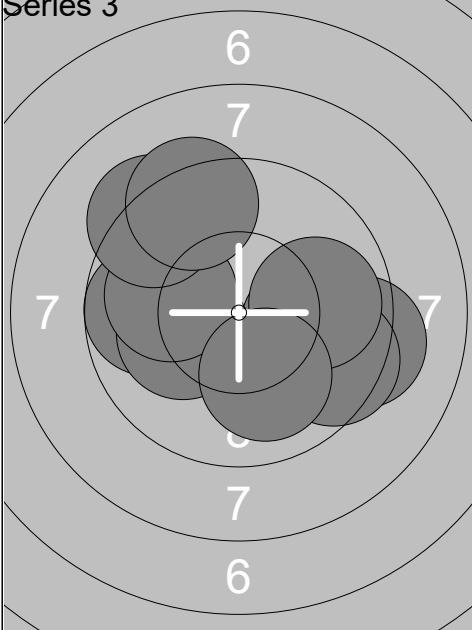
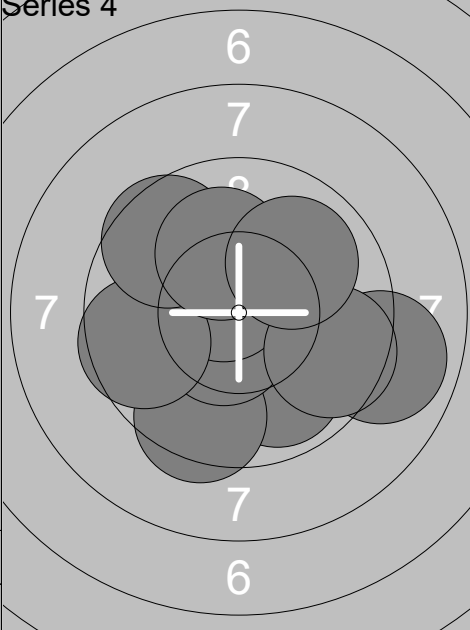
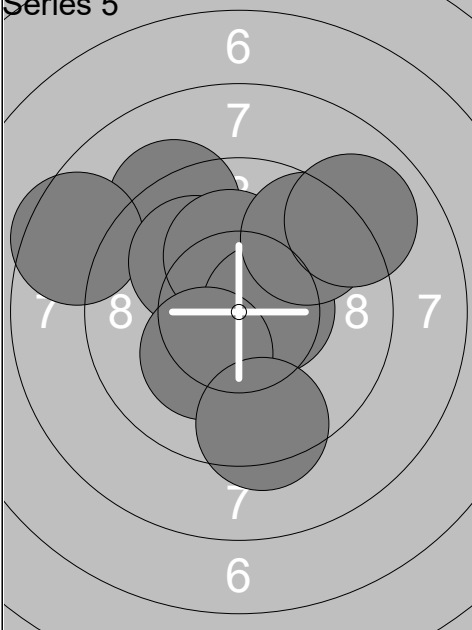
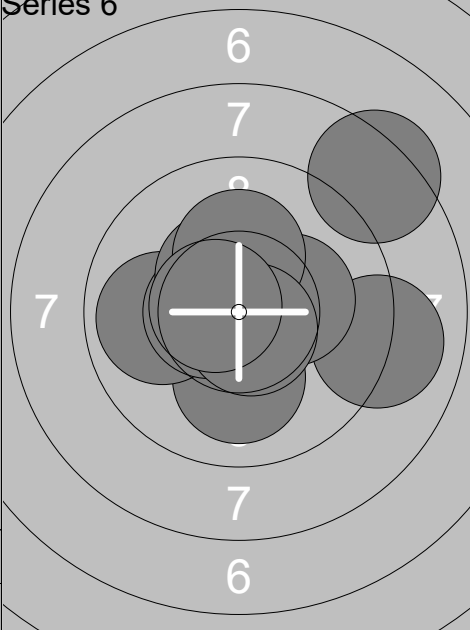
Relay	Lane	Eirik Mahle Gisle		
1 Air		NOR	MJ	Rifle
18.02.2024		Denmark Open Air Day 3	Denmark Open Air 2024	
Series 1 	1: 10.0 ↘	Series 2 	1: 10.0 ↗	
	2: 9.0 →		2: 9.2 →	
	3: 9.9 ↙		3: 10.6x ↙	
	4: 9.6 ↗		4: 10.4x →	
	5: 9.2 ↘		5: 9.8 →	
	6: 9.9 →		6: 10.4x →	
	7: 10.4x ↙		7: 10.7x ↓	
	8: 10.6x ↙		8: 10.4x ↗	
	9: 10.6x ↗		9: 9.6 ←	
	10: 9.8 ↘		10: 10.3x →	
	Series 94.0		Series 97.0	
	94.0		191.0	
Series 3 	1: 9.3 →	Series 4 	1: 8.9 →	
	2: 9.7 ←		2: 9.9 ↓	
	3: 10.0 →		3: 9.4 ↓	
	4: 10.1 ←		4: 10.5x ↙	
	5: 10.0 ←		5: 10.6x ↗	
	6: 9.5 ↘		6: 9.6 ←	
	7: 9.2 ↗		7: 9.6 ↗	
	8: 9.3 ↗		8: 9.6 →	
	9: 9.9 →		9: 10.1 ↑	
	10: 10.0 ↓		10: 9.9 ↗	
	Series 94.0		Series 92.0	
	285.0		377.0	
Series 5 	1: 9.3 ↗	Series 6 	1: 10.1 ↓	
	2: 8.5 ←		2: 9.0 →	
	3: 10.3x ↙		3: 9.9 ←	
	4: 10.0 ↗		4: 10.2x →	
	5: 10.1 ↑		5: 10.5x ←	
	6: 10.5x →		6: 10.4x ↗	
	7: 10.2x ↙		7: 10.2x ↑	
	8: 9.4 ↓		8: 8.3 ↗	
	9: 9.6 ↗		9: 10.7x ↘	
	10: 9.0 ↗		10: 10.6x ←	
	Series 94.0		Series 96.0	
	471.0		567.0	

Relay	Lane	Sylvester Svendsen		
1	27	DEN	MJ	Rifle
18.02.2024	Denmark Open Air Day 3	Denmark Open Air 2024		
Series 1 	1: 10.6x ←	Series 2 	1: 10.4x ↗	
	2: 10.3x ↑		2: 9.5 ↓	
	3: 9.9 ↓		3: 9.4 →	
	4: 10.4x ↙		4: 10.1 ↘	
	5: 10.2x ↗		5: 10.6x →	
	6: 10.3x ←		6: 9.3 ↘	
	7: 10.1 ↓		7: 10.4x →	
	8: 10.3x ←		8: 10.4x ↘	
	9: 10.2x ↙		9: 10.0 ↓	
	10: 10.3x ↓		10: 10.3x ↘	
	Series 99.0	Series 97.0		
	99.0		196.0	
Series 3 	1: 10.5x →	Series 4 	1: 10.4x ↓	
	2: 10.7x ↙		2: 10.2x ↙	
	3: 10.1 →		3: 10.4x ←	
	4: 9.7 ↘		4: 10.4x ↖	
	5: 10.2x ↑		5: 9.9 →	
	6: 10.3x ↑		6: 9.9 ↗	
	7: 10.3x ↓		7: 10.1 ↘	
	8: 10.6x →		8: 10.6x ←	
	9: 9.3 ←		9: 10.1 ↗	
	10: 9.9 ←		10: 10.5x ↑	
	Series 97.0	Series 98.0		
	293.0		391.0	
Series 5 	1: 10.2x ←	Series 6 	1: 10.4x →	
	2: 9.9 ↖		2: 10.2x ↑	
	3: 10.4x ↗		3: 10.3x →	
	4: 9.6 ←		4: 10.3x ←	
	5: 10.2x ↗		5: 10.7x ↗	
	6: 10.3x →		6: 10.1 ←	
	7: 9.6 ↑		7: 10.4x ↖	
	8: 10.5x ↗		8: 10.1 ↑	
	9: 10.1 ↗		9: 9.9 ↑	
	10: 9.7 →		10: 10.2x ←	
	Series 96.0	Series 99.0		
	487.0		586.0	

Relay	Lane	Pontus Kallin		
1 Air	30	SWE	MJ	Rifle
18.02.2024	Denmark Open Air Day 3	Denmark Open Air 2024		
Series 1 	1: 10.3x ↙	Series 2 	1: 10.3x ↑	
	2: 9.9 ↗		2: 10.5x ↑	
	3: 10.8x ➡		3: 10.1 ←	
	4: 10.2x ➡		4: 10.7x ←	
	5: 10.4x ↓		5: 10.3x ↖	
	6: 10.1 ↘		6: 10.3x ➡	
	7: 10.7x ↙		7: 10.7x ↘	
	8: 10.1 ←		8: 10.7x ↗	
	9: 10.5x ↗		9: 10.4x ➡	
	10: 10.4x ➡		10: 10.4x ↖	
	Series 99.0	Series 100.0		
	99.0		199.0	
Series 3 	1: 10.5x ↓	Series 4 	1: 10.5x ↗	
	2: 9.4 ↓		2: 10.6x ↘	
	3: 10.5x ↙		3: 10.7x ↑	
	4: 9.8 ↘		4: 10.3x ↖	
	5: 9.7 ↑		5: 10.8x ↑	
	6: 10.1 ↗		6: 10.6x ↑	
	7: 10.4x ↙		7: 10.8x ↗	
	8: 10.2x ➡		8: 10.1 ←	
	9: 9.8 ➡		9: 10.2x ↑	
	10: 9.9 ➡		10: 10.0 ↑	
	Series 95.0	Series 100.0		
	294.0		394.0	
Series 5 	1: 10.5x ➡	Series 6 	1: 10.3x ➡	
	2: 10.4x ↙		2: 10.2x ↑	
	3: 9.7 ➡		3: 10.4x ↙	
	4: 10.6x ↓		4: 10.2x ←	
	5: 10.5x ➡		5: 10.5x ↖	
	6: 10.9x ←		6: 10.2x ↑	
	7: 10.7x ↗		7: 10.3x ↑	
	8: 10.5x ➡		8: 10.4x ↑	
	9: 10.1 ↘		9: 10.2x ↓	
	10: 9.4 ←		10: 10.7x ←	
	Series 98.0	Series 100.0		
	492.0		592.0	

Relay	Lane	Storm Franzen		
1	31	DEN	MJ	Rifle
18.02.2024	Denmark Open Air Day 3	Denmark Open Air 2024		
Series 1 	1: 10.1 ↗	Series 2 	1: 10.7x ↗	
	2: 10.5x ←		2: 9.9 ➡	
	3: 9.9 ←		3: 10.5x ↙	
	4: 10.1 ➡		4: 10.6x ↑	
	5: 9.9 ←		5: 9.9 ↗	
	6: 10.1 ↑		6: 9.7 ↑	
	7: 10.5x ↑		7: 10.3x ↘	
	8: 10.4x ➡		8: 10.1 ↖	
	9: 10.6x ↓		9: 10.5x ➡	
	10: 10.4x ↑		10: 9.9 ➡	
	Series 98.0	Series 96.0		
	98.0		194.0	
Series 3 	1: 9.8 ↗	Series 4 	1: 10.0 ←	
	2: 9.6 ↗		2: 10.5x ↑	
	3: 9.9 ↑		3: 10.4x ↘	
	4: 10.6x ←		4: 9.8 ←	
	5: 10.3x ➡		5: 9.8 ←	
	6: 10.3x ↑		6: 10.2x ↙	
	7: 10.2x ➡		7: 10.2x ←	
	8: 9.8 ➡		8: 9.8 ↑	
	9: 10.6x ↘		9: 10.6x ↖	
	10: 9.7 ←		10: 10.8x ➡	
	Series 95.0	Series 97.0		
	289.0		386.0	
Series 5 	1: 10.9x ↗	Series 6 	1: 10.5x ↓	
	2: 10.0 ↗		2: 10.5x ↙	
	3: 9.8 ↗		3: 8.4 ↓	
	4: 10.1 ←		4: 10.6x ↓	
	5: 10.6x ➡		5: 10.8x ➡	
	6: 10.6x ➡		6: 9.9 ➡	
	7: 10.4x ➡		7: 10.0 ↑	
	8: 9.6 ↑		8: 10.7x ↓	
	9: 10.3x ↗		9: 9.2 ↑	
	10: 10.4x ➡		10: 9.6 ↑	
	Series 98.0	Series 95.0		
	484.0		579.0	

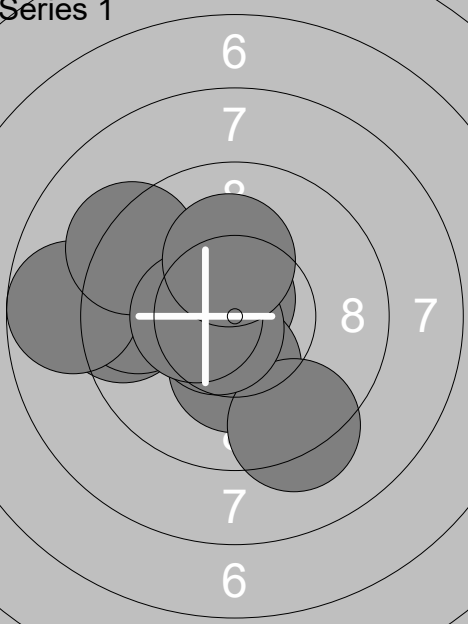
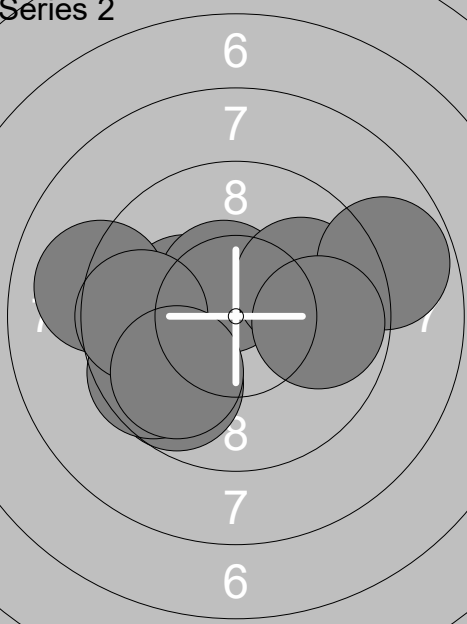
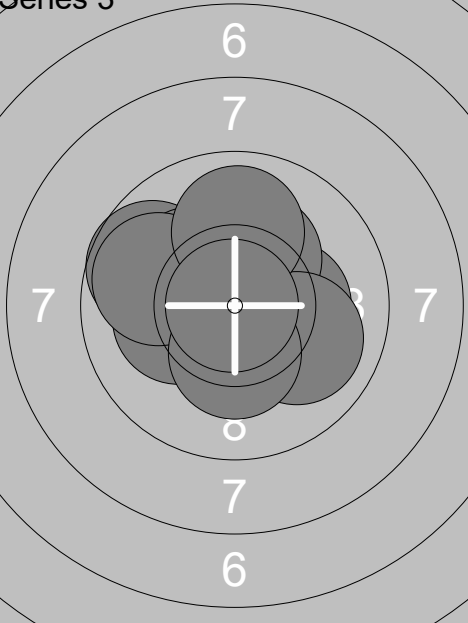
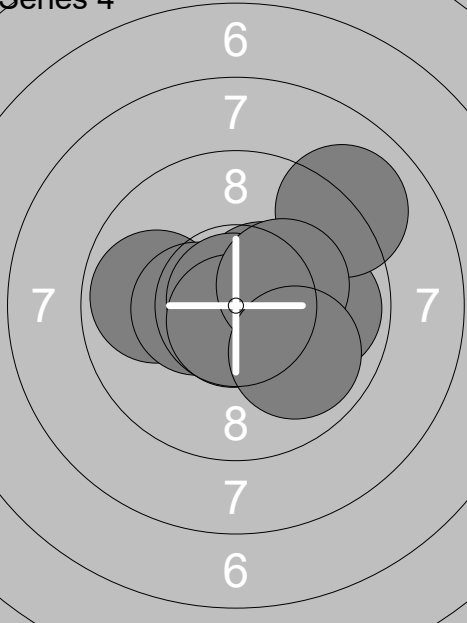
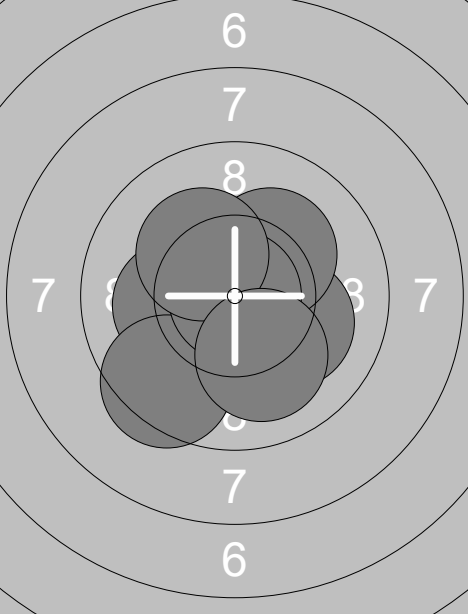
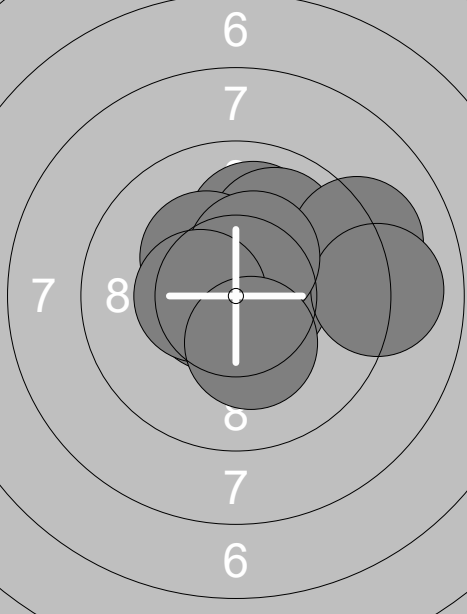
Relay	Lane	Keven Axel Sørensen		
1 Air		DEN	MJ	Rifle
18.02.2024		Denmark Open Air Day 3	Denmark Open Air 2024	
Series 1 	1: 10.7x ↗	Series 2 	1: 9.7 ↘	
	2: 9.4 ←		2: 10.2x ↙	
	3: 9.6 ←		3: 9.6 ↙	
	4: 10.3x ↓		4: 10.5x ↗	
	5: 8.7 ←		5: 9.1 ←	
	6: 9.2 ↓		6: 9.9 ↗	
	7: 10.7x ↙		7: 9.7 ←	
	8: 9.2 ↖		8: 9.8 ↘	
	9: 10.4x ↙		9: 8.8 ↗	
	10: 10.2x ↗		10: 9.8 →	
	Series 94.0		Series 91.0	
	94.0		185.0	
Series 3 	1: 10.2x ↙	Series 4 	1: 10.3x →	
	2: 10.2x →		2: 9.8 →	
	3: 9.7 ↖		3: 9.8 ←	
	4: 10.2x ↗		4: 9.0 ↗	
	5: 10.0 ↘		5: 10.4x ↙	
	6: 10.2x ↖		6: 10.5x ↗	
	7: 9.8 ↖		7: 10.8x ↖	
	8: 10.3x ↓		8: 10.7x ↓	
	9: 9.9 ↗		9: 10.2x →	
	10: 10.9x ↙		10: 9.9 ↘	
	Series 97.0		Series 96.0	
	282.0		378.0	
Series 5 	1: 10.3x ↘	Series 6 	1: 10.6x ↙	
	2: 10.8x ↖		2: 10.6x →	
	3: 10.7x ↓		3: 10.0 ↗	
	4: 10.1 ↘		4: 9.9 ↗	
	5: 10.2x ↗		5: 9.1 ↗	
	6: 10.2x ↙		6: 10.3x ↖	
	7: 9.5 ↘		7: 9.0 →	
	8: 10.9x		8: 10.4x ↗	
	9: 10.2x ↖		9: 10.5x ↙	
	10: 10.0 ↓		10: 10.2x ↓	
	Series 99.0		Series 97.0	
	477.0		574.0	