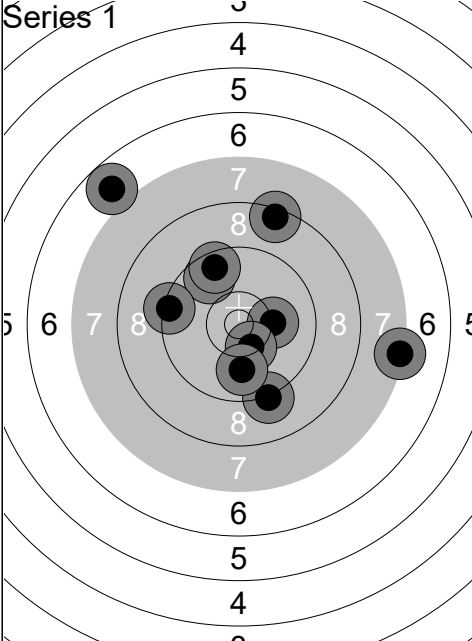
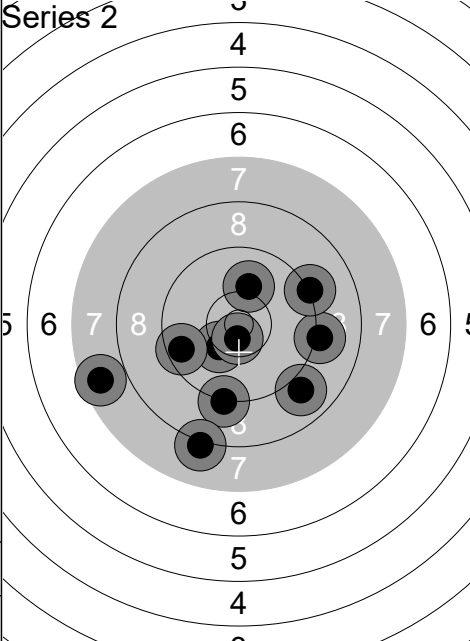
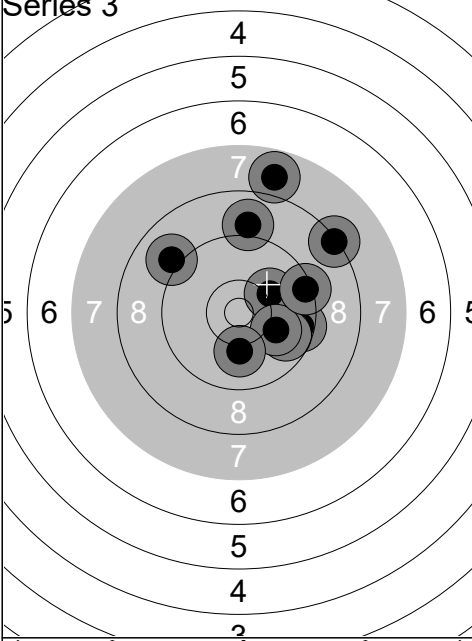
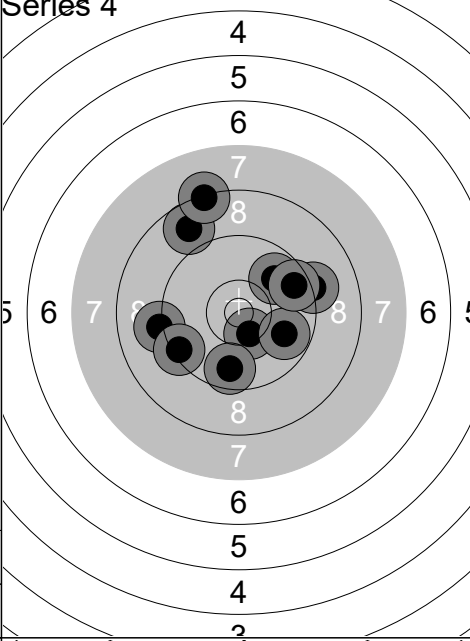
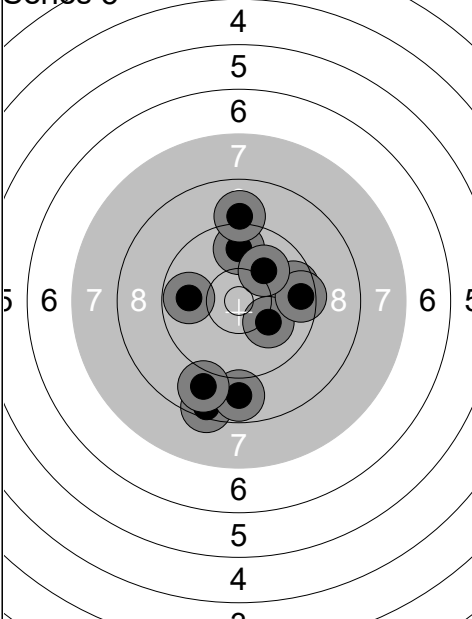
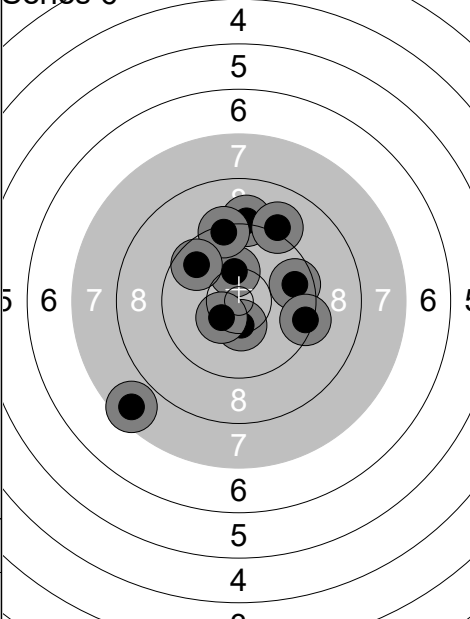
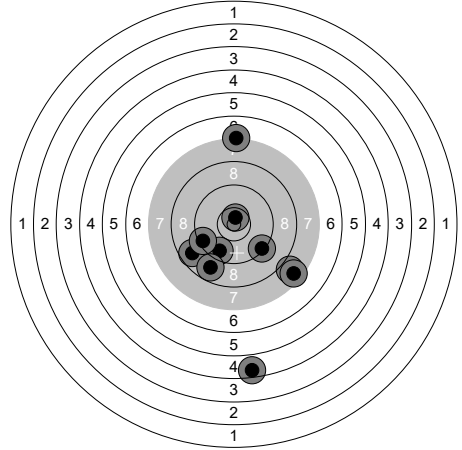
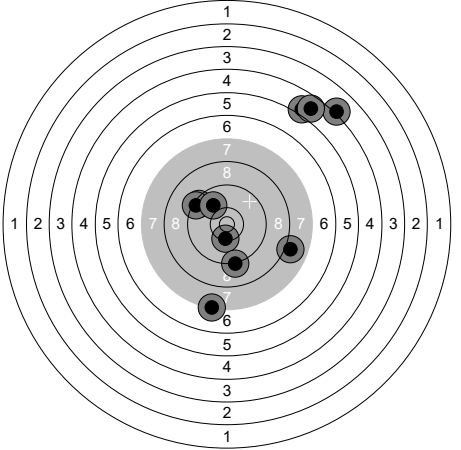
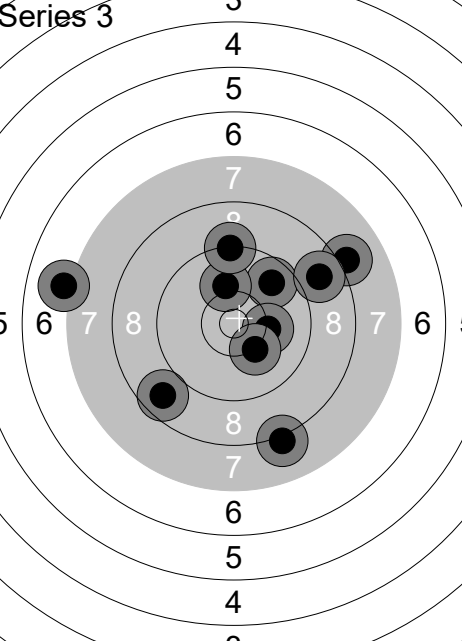
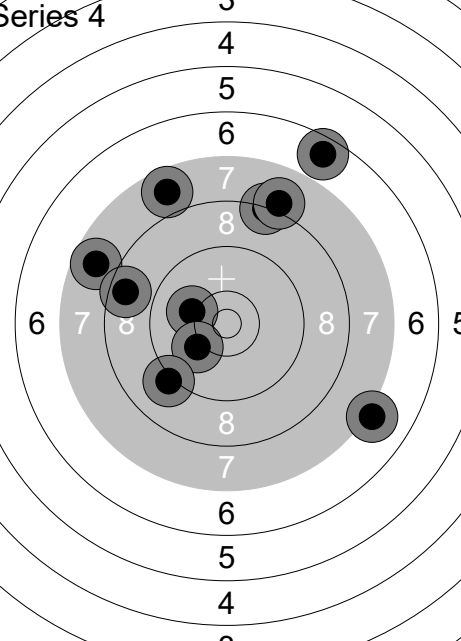
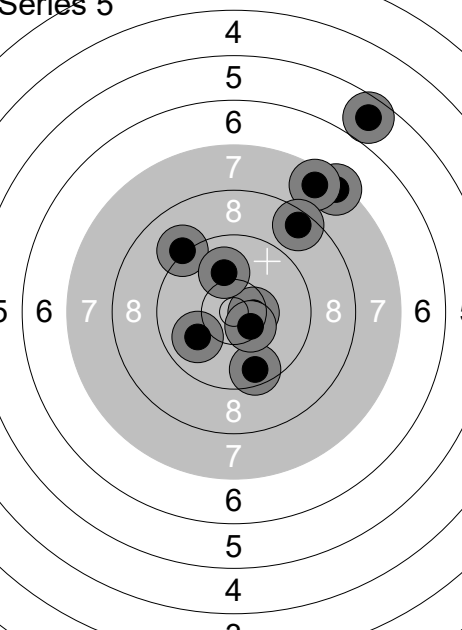
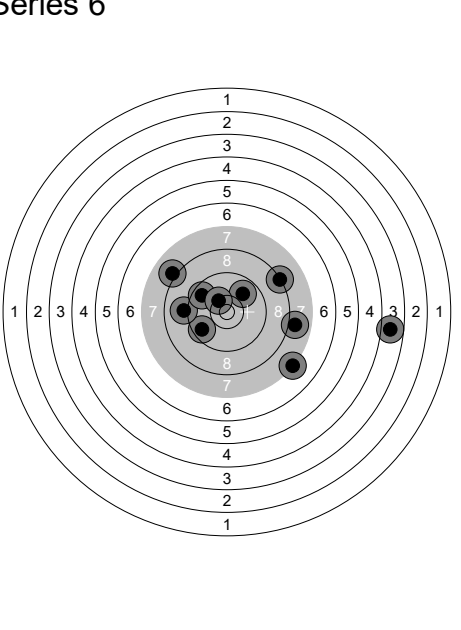
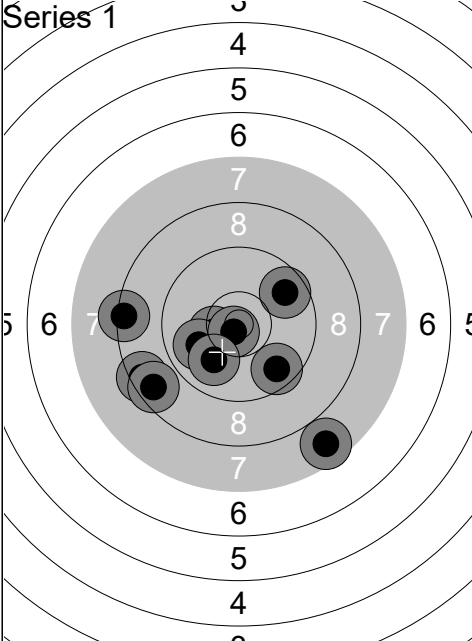
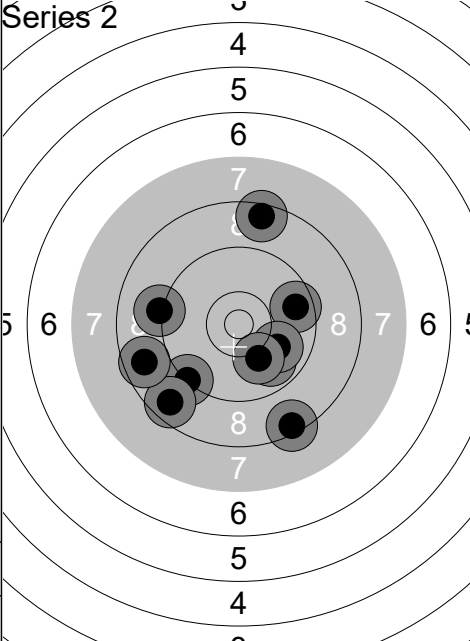
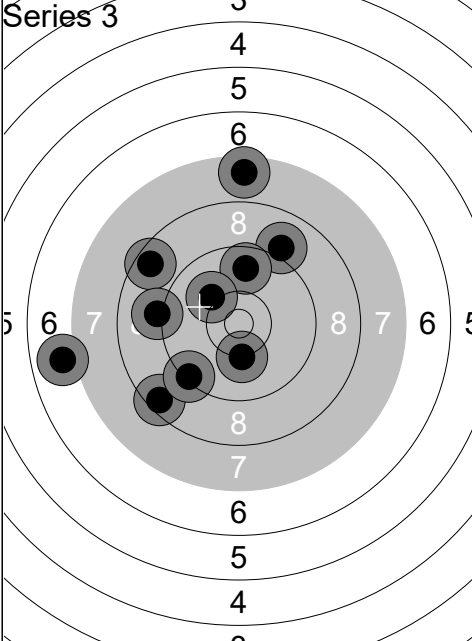
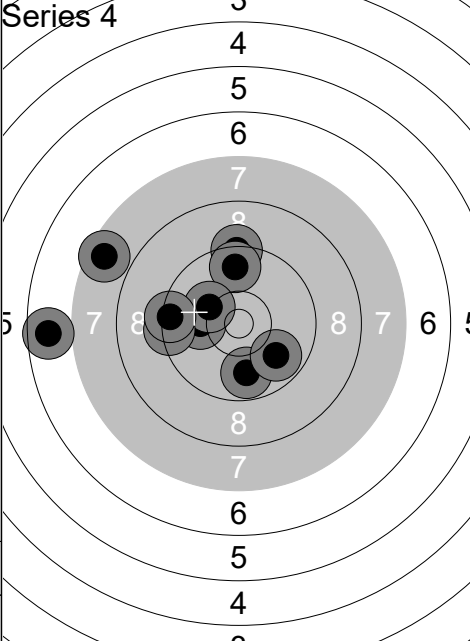
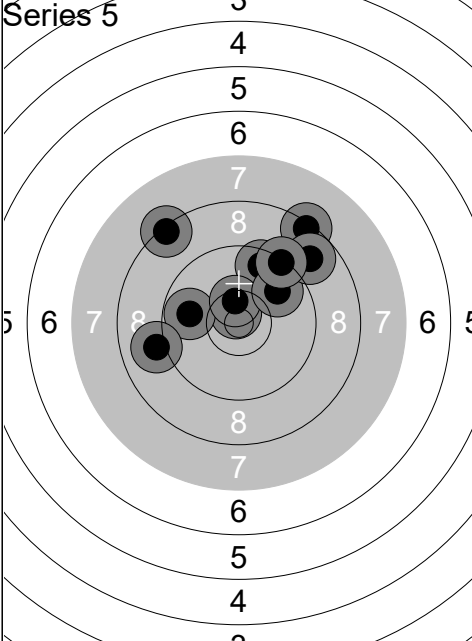
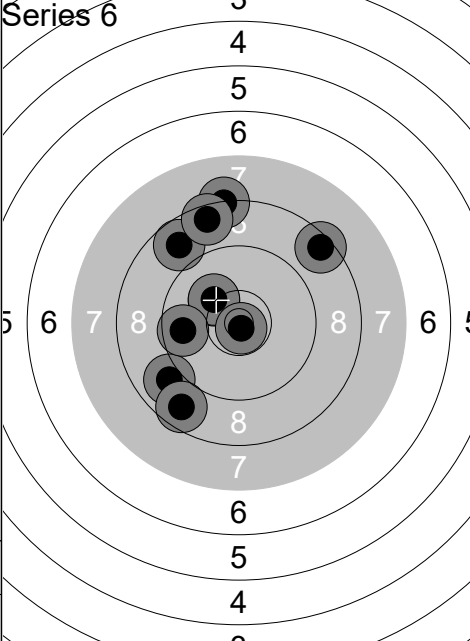

Relay	Lane	Amy Lee	
1	2		
Qual Day 1		DEN	Wp P
11.02.2026		Denmark Open Air 2026	Denmark Open Air 2026
Series 1 	1:	8.4	↗
	2:	9.7	↗
	3:	6.8	↗
	4:	9.6	↗
	5:	9.4	↖
	6:	10.2	→
	7:	9.2	↘
	8:	10.4x	↘
	9:	9.9	↘
	10:	7.3	→
Series		86 (1x)	
		86 (1x)	
Series 2 	1:	7.6	↖
	2:	10.1	↗
	3:	10.3	↘
	4:	9.2	↘
	5:	8.1	↘
	6:	9.1	→
	7:	9.2	↗
	8:	10.6x	↘
	9:	8.9	↘
	10:	9.6	↖
Series		89 (1x)	
		175 (2x)	
Series 3 	1:	10.2	↗
	2:	9.5	→
	3:	9.8	↘
	4:	9.0	↗
	5:	9.0	↗
	6:	10.0	→
	7:	10.1	↘
	8:	7.8	↗
	9:	8.3	↗
	10:	9.4	→
Series		90 (0x)	
		265 (2x)	
Series 4 	1:	9.2	↗
	2:	10.4x	↘
	3:	9.8	↘
	4:	9.9	↗
	5:	9.6	↗
	6:	8.8	↗
	7:	9.7	↘
	8:	9.1	↖
	9:	9.4	↖
	10:	8.3	↗
Series		89 (1x)	
		354 (3x)	
Series 5 	1:	9.8	↗
	2:	9.7	→
	3:	10.1	↘
	4:	8.5	↘
	5:	8.8	↘
	6:	9.8	↖
	7:	8.9	↘
	8:	9.6	→
	9:	9.1	↗
	10:	10.1	↗
Series		89 (0x)	
		443 (3x)	
Series 6 	1:	9.2	↗
	2:	9.7	→
	3:	10.3	↗
	4:	9.1	↗
	5:	10.4x	↘
	6:	9.4	↗
	7:	7.6	↘
	8:	9.7	↗
	9:	9.4	→
	10:	10.4x	↘
Series		91 (2x)	
		534 (5x)	

Relay	Lane	Ann Helen Aune	
1	3		
Qual Day 1	NOR	Wp	P
11.02.2026	Denmark Open Air 2026	Denmark Open Air 2026	
Series 1 	1: 9.4 ↓	Series 2 	1: 10.1 →
	2: 9.5 →		2: 10.1 ↙
	3: 9.1 ↑		3: 9.7 ←
	4: 10.6x ↓		4: 9.7 →
	5: 8.6 →		5: 10.5x ↑
	6: 9.7 →		6: 8.5 ↓
	7: 10.2 ↙		7: 9.3 ←
	8: 10.8x ↗		8: 10.6x ↑
	9: 9.4 ↖		9: 9.9 ↓
	10: 8.4 ↑		10: 10.3 ↗
Series 91 (2x)		Series 94 (2x)	
91 (2x)		185 (4x)	
Series 3 	1: 10.4x ↗	Series 4 	1: 7.1 ↓
	2: 9.7 →		2: 8.9 ↖
	3: 10.7x ↑		3: 9.9 ↑
	4: 10.6x →		4: 9.4 ←
	5: 10.2 ↑		5: 10.5x →
	6: 8.3 ↓		6: 10.7x →
	7: 10.7x ←		7: 9.7 →
	8: 9.0 ↓		8: 9.1 ↓
	9: 10.2 ↓		9: 9.7 ↖
	10: 10.3 ←		10: 9.9 ↘
Series 96 (4x)		Series 89 (2x)	
281 (8x)		370 (10x)	
Series 5 	1: 10.4x →	Series 6 	1: 10.2 →
	2: 9.7 ↓		2: 9.9 ↘
	3: 8.6 ↖		3: 10.1 ↗
	4: 10.4x ↖		4: 8.9 ↖
	5: 9.6 ↗		5: 9.1 ↑
	6: 10.3 ↖		6: 8.7 ←
	7: 10.0 ↗		7: 9.9 ↙
	8: 9.9 ←		8: 8.9 →
	9: 10.1 →		9: 9.4 ↑
	10: 9.9 ↓		10: 10.6x ↙
Series 94 (2x)		Series 90 (1x)	
464 (12x)		554 (13x)	

Relay	Lane	Astrid Jensen		
1	4	DEN	Wp	P
Qual Day 1		Denmark Open Air 2026		Denmark Open Air 2026
11.02.2026				
Series 1 	1: 10.1 ↙	Series 2 	1: 8.7 ↑	
	2: 8.6 ↓		2: 10.4x ↗	
	3: 10.6x ↖		3: 9.2 ↑	
	4: 9.3 ↗		4: 10.0 ↗	
	5: 10.1 ↑		5: 7.8 ↓	
	6: 10.3 ↗		6: 7.9 ←	
	7: 10.8x ←		7: 9.6 →	
	8: 8.5 ↗		8: 10.0 ←	
	9: 9.2 ↗		9: 9.0 ↘	
	10: 9.7 ←		10: 5.9 ←	
	Series 93 (2x)		Series 84 (1x)	
	93 (2x)		177 (3x)	
Series 3 	1: 9.9 ↓	Series 4 	1: 9.9 →	
	2: 9.1 ↓		2: 7.0 ←	
	3: 9.6 ↙		3: 10.3 ←	
	4: 10.7x ↑		4: 8.6 →	
	5: 9.8 ↘		5: 8.4 →	
	6: 7.0 →		6: 7.6 →	
	7: 8.2 ←		7: 8.6 ↑	
	8: 9.1 ↗		8: 9.1 ↖	
	9: 8.1 ↓		9: 10.0 ←	
	10: 10.1 ↑		10: 9.5 ↗	
	Series 88 (1x)		Series 85 (0x)	
	265 (4x)		350 (4x)	
Series 5 	1: 8.3 ↖	Series 6 	1: 7.8 →	
	2: 9.5 ↖		2: 9.5 ↓	
	3: 10.3 ↗		3: 8.1 ↓	
	4: 10.6x ↑		4: 10.0 →	
	5: 9.0 ↖		5: 8.3 ↓	
	6: 10.7x ↘		6: 9.5 ↗	
	7: 9.2 ↑		7: 8.5 ↗	
	8: 9.5 ↗		8: 9.7 ↘	
	9: 10.6x ↓		9: 10.4x →	
	10: 10.2 ↘		10: 7.9 ↖	
	Series 94 (3x)		Series 85 (1x)	
	444 (7x)		529 (8x)	

Relay	Lane	Birgitte Eriksen		
1	5			
Qual Day 1	DEN	Wp	P	
11.02.2026	Denmark Open Air 2026	Denmark Open Air 2026		
Series 1 	1: 7.2 ↑	Series 2 	1: 5.0 ↗	
	2: 8.8 ↙		2: 9.4 ↖	
	3: 7.8 ↘		3: 9.4 ↖	
	4: 9.7 ↓		4: 7.3 ↓	
	5: 7.6 ↘		5: 8.0 →	
	6: 10.7x ↑		6: 4.1 ↗	
	7: 9.4 ↙		7: 10.3 ↓	
	8: 4.5 ↓		8: 4.7 ↗	
	9: 9.3 ↘		9: 9.9 ↖	
	10: 8.8 ↓		10: 9.2 ↓	
	Series 78 (1x)		Series 74 (0x)	
	78 (1x)		152 (1x)	
Series 3 	1: 9.7 ↗	Series 4 	1: 8.3 ↑	
	2: 10.2 →		2: 10.1 ↖	
	3: 8.1 ↓		3: 10.1 ↖	
	4: 10.2 ↓		4: 7.1 ↘	
	5: 8.1 ↗		5: 7.8 ↖	
	6: 10.1 ↑		6: 7.7 ↗	
	7: 8.8 →		7: 8.6 ↖	
	8: 8.7 ↙		8: 8.0 ↗	
	9: 9.3 ↑		9: 9.1 ↖	
	10: 7.1 ↖		10: 6.6 ↗	
	Series 87 (0x)		Series 80 (0x)	
	239 (1x)		319 (1x)	
Series 5 	1: 7.4 ↗	Series 6 	1: 9.6 ↖	
	2: 7.6 ↗		2: 9.1 ↖	
	3: 9.2 ↖		3: 7.9 →	
	4: 9.6 ↓		4: 9.9 ↗	
	5: 10.5x →		5: 8.3 ↗	
	6: 10.0 ↖		6: 3.8 →	
	7: 10.0 ↑		7: 9.6 ↖	
	8: 8.6 ↗		8: 8.0 ↖	
	9: 5.7 ↗		9: 7.3 ↘	
	10: 10.5x ↘		10: 10.3 ↖	
	Series 85 (2x)		Series 79 (0x)	
	404 (3x)		483 (3x)	

Relay	Lane	Cecilia Blom		
Qual Day 1	SWE	Wp	P	
11.02.2026	Denmark Open Air 2026	Denmark Open Air 2026		
Series 1 	1: 9.6 ↘	Series 2 	1: 9.3 ↙	
	2: 10.4 ←		2: 9.9 ↘	
	3: 9.9 ←		3: 8.4 ↘	
	4: 10.7x ↘		4: 9.6 →	
	5: 8.4 ←		5: 10.0 ↘	
	6: 8.5 ←		6: 8.6 ↙	
	7: 10.0 ↘		7: 10.1 ↘	
	8: 7.7 ↘		8: 9.2 ←	
	9: 9.7 ↗		9: 8.7 ←	
	10: 8.6 ←		10: 8.5 ↑	
Series 88 (1x)	Series 88 (0x)			
88 (1x)	176 (1x)			
Series 3 	1: 6.9 ←	Series 4 	1: 9.8 ↓	
	2: 9.0 ↗		2: 9.9 ↘	
	3: 8.6 ↖		3: 10.1 ←	
	4: 7.6 ↑		4: 9.3 ↑	
	5: 9.1 ←		5: 9.7 ↑	
	6: 8.5 ↙		6: 7.6 ↖	
	7: 9.7 ↑		7: 10.2 ↖	
	8: 10.1 ↖		8: 6.7 ←	
	9: 10.2 ↓		9: 9.4 ←	
	10: 9.3 ↘		10: 9.4 ←	
Series 85 (0x)	Series 87 (0x)			
261 (1x)	348 (1x)			
Series 5 	1: 8.3 ↖	Series 6 	1: 10.2 ↖	
	2: 9.6 ↑		2: 10.2 ↖	
	3: 10.7x ↑		3: 9.0 ↙	
	4: 9.8 ←		4: 8.3 ↑	
	5: 8.4 ↗		5: 8.8 ↖	
	6: 9.0 ←		6: 8.7 ↙	
	7: 10.5x ↑		7: 10.8x ↘	
	8: 9.8 ↗		8: 8.6 ↑	
	9: 8.8 ↗		9: 8.5 ↗	
	10: 9.3 ↗		10: 9.7 ←	
Series 89 (2x)	Series 88 (1x)			
437 (3x)	525 (4x)			

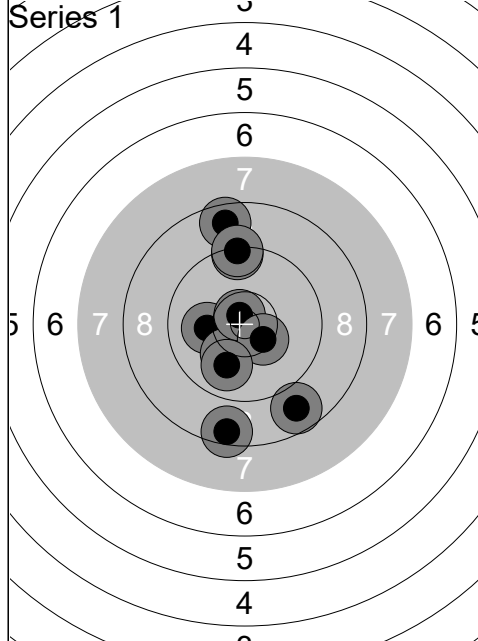

1:	8.6	↑
2:	10.1	←
3:	10.2	↘
4:	10.7x	↗
5:	10.4x	↘
6:	9.9	↘
7:	9.4	↑
8:	8.5	↘
9:	9.3	↑
10:	8.8	↘
Series	91 (2x)	
	91 (2x)	

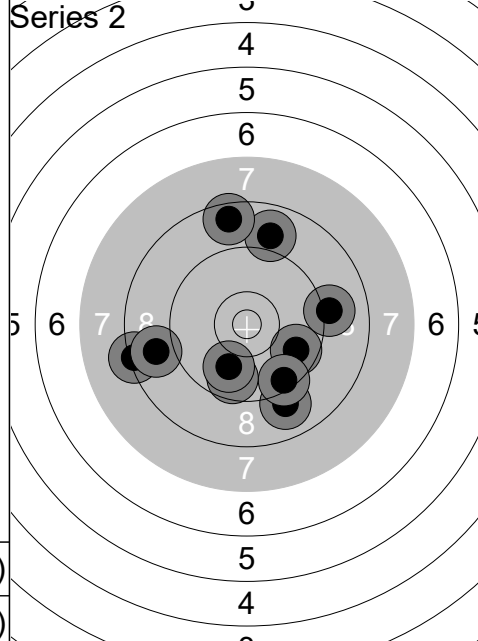

1:	8.3	←
2:	9.0	↘
3:	9.7	↘
4:	8.9	↑
5:	8.6	↑
6:	9.1	→
7:	9.4	↘
8:	8.8	←
9:	9.7	↘
10:	9.9	↘
Series	86 (0x)	
	177 (2x)	

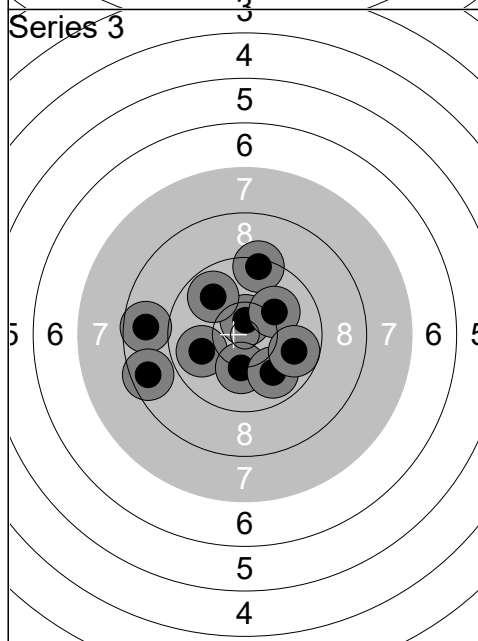

1:	9.4	↑
2:	10.6x	↑
3:	9.8	↖
4:	9.9	←
5:	10.1	↗
6:	10.2	↘
7:	8.7	←
8:	8.6	←
9:	9.9	↘
10:	9.8	→
Series	91 (1x)	
	268 (3x)	

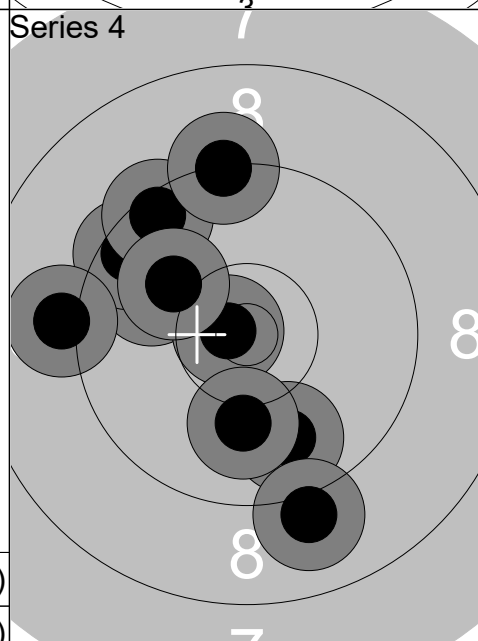

1:	9.9	←
2:	9.8	↘
3:	10.8x	←
4:	9.5	↗
5:	9.1	←
6:	9.4	↗
7:	9.0	↘
8:	9.3	↑
9:	10.1	↖
10:	10.1	↘
Series	93 (1x)	
	361 (4x)	

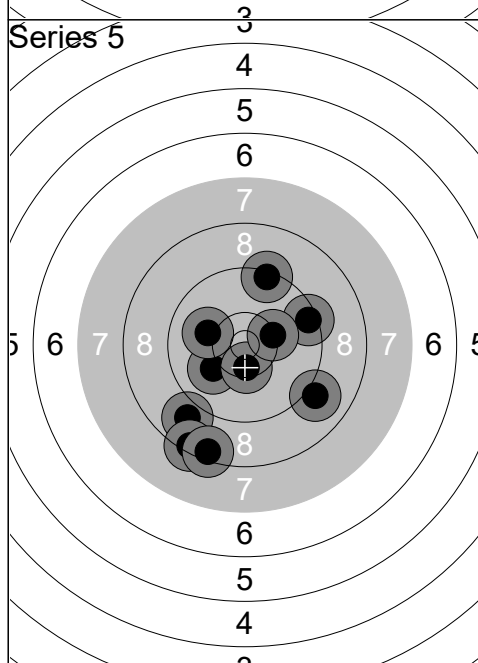

1:	9.4	→
2:	10.1	←
3:	9.3	↑
4:	8.9	↘
5:	9.0	↘
6:	10.5x	↘
7:	10.1	←
8:	10.3	→
9:	8.4	↘
10:	8.4	↘
Series	91 (1x)	
	452 (5x)	

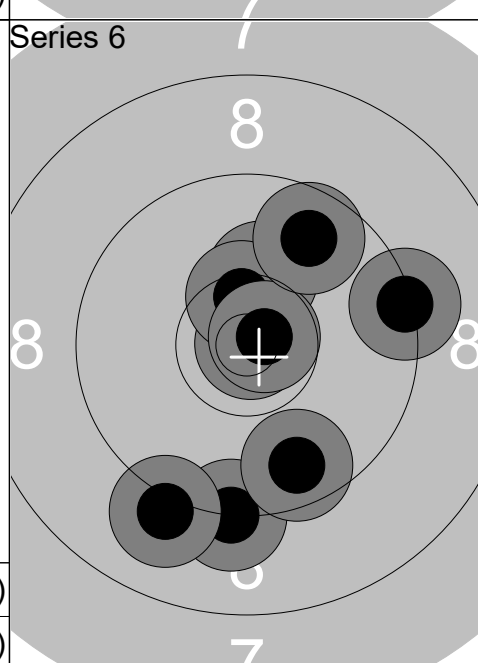

1:	9.2	↘
2:	9.1	↘
3:	10.9x	→
4:	9.6	↘
5:	10.4x	↑
6:	10.2	↑
7:	10.5x	↑
8:	9.3	→
9:	10.8x	↗
10:	9.7	↑
Series	95 (4x)	
	547 (9x)	

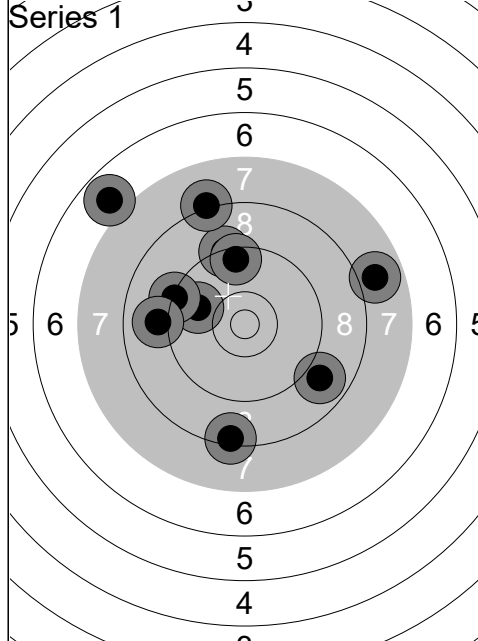

1: 9.9	←
2: 8.9	↘
3: 6.8	↗
4: 8.4	↓
5: 9.3	←
6: 9.3	↑
7: 9.5	↑
8: 8.2	↑
9: 9.0	←
10: 7.9	↗
Series	82 (0x)
	82 (0x)

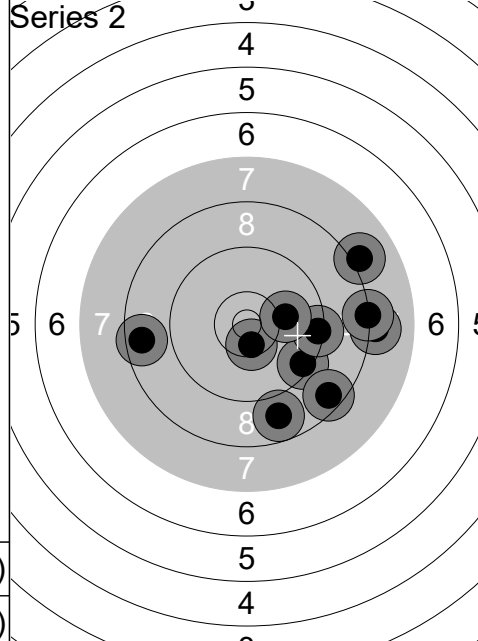

1: 9.4	↘
2: 8.1	↗
3: 8.1	→
4: 10.5x	↓
5: 8.6	←
6: 8.5	↘
7: 8.3	→
8: 9.4	→
9: 8.8	↓
10: 10.1	→
Series	86 (1x)
	168 (1x)

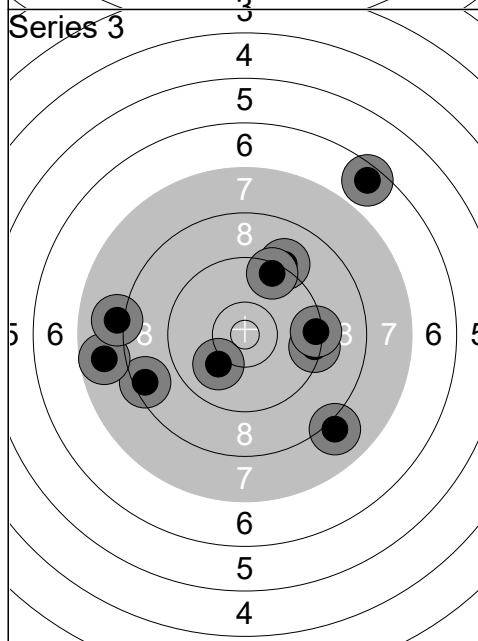

1: 9.2	↗
2: 8.5	←
3: 9.5	↗
4: 7.8	←
5: 8.1	←
6: 6.6	↗
7: 9.4	→
8: 10.1	↘
9: 8.0	↘
10: 9.4	→
Series	83 (0x)
	251 (1x)

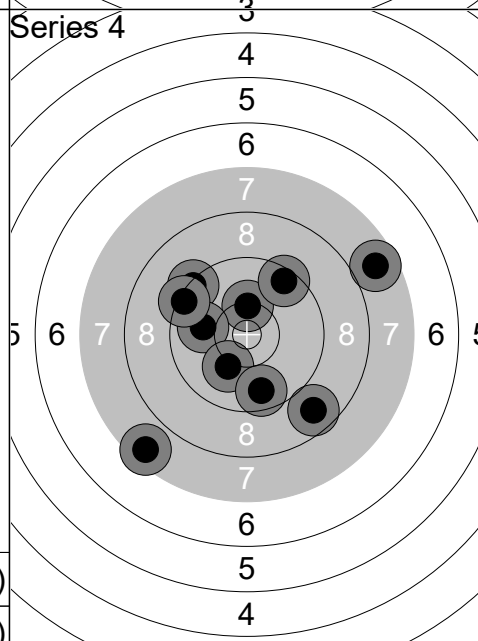

1: 9.3	↖
2: 10.3	↑
3: 10.0	←
4: 10.1	↘
5: 7.7	↗
6: 9.7	↓
7: 9.5	↗
8: 8.7	↘
9: 9.4	↖
10: 7.5	↘
Series	88 (0x)
	339 (1x)

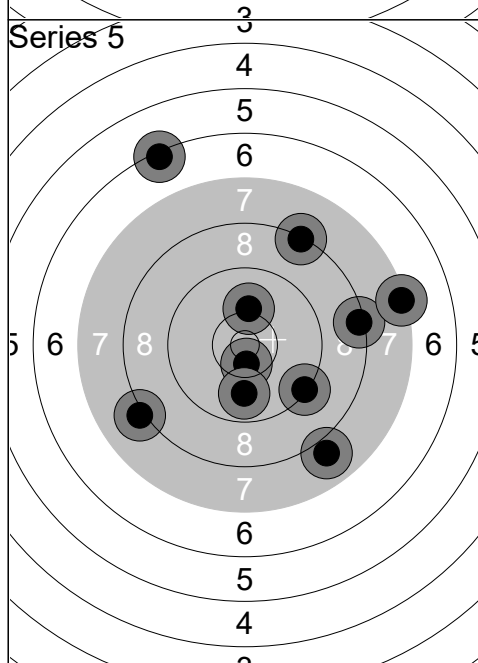

1: 8.1	←
2: 6.3	↗
3: 10.5x	↓
4: 9.9	↓
5: 9.3	↘
6: 8.4	→
7: 7.3	→
8: 10.1	↑
9: 7.9	↘
10: 8.3	↗
Series	82 (1x)
	421 (2x)

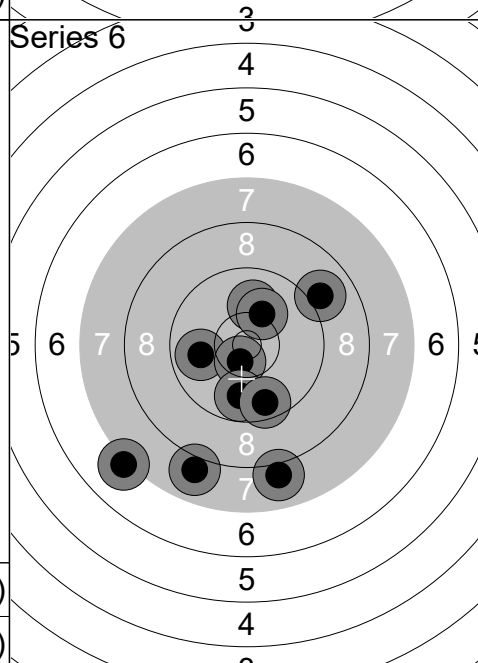

1: 10.1	↑
2: 7.9	↘
3: 9.9	←
4: 10.6x	↘
5: 8.0	↓
6: 10.2	↗
7: 7.1	↖
8: 9.0	↗
9: 9.8	↓
10: 9.6	↘
Series	88 (1x)
	509 (3x)

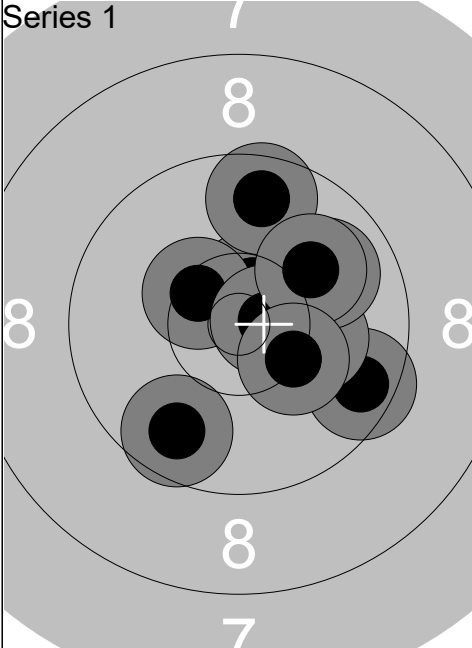
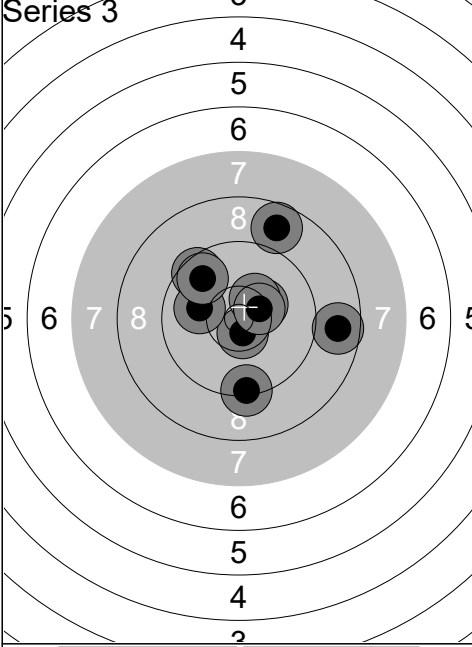
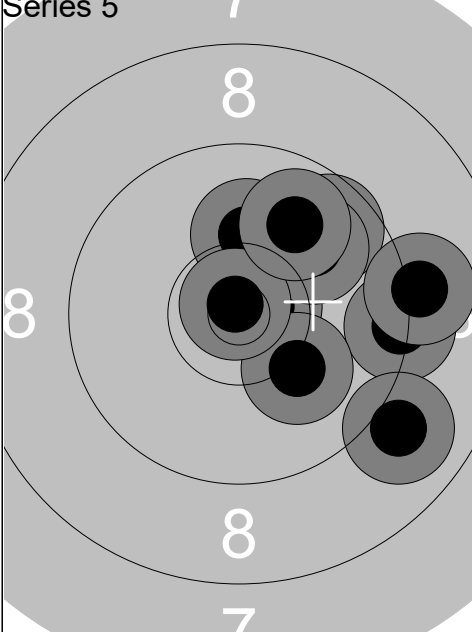
Relay	Lane	Celina Becker		
1	9	GER	Wp	P
Qual Day 1		Denmark Open Air 2026	Denmark Open Air 2026	
11.02.2026				
Series 1		1: 10.5x ↗ 2: 10.4x ↖ 3: 9.6 → 4: 10.2 → 5: 9.7 ↓ 6: 9.7 ↑ 7: 10.7x → 8: 9.9 ↗ 9: 10.0 ↗ 10: 10.3 ↘	Series 2	1: 10.7x ↖ 2: 9.7 ← 3: 10.1 ← 4: 9.0 ↘ 5: 10.4x ↖ 6: 8.7 → 7: 10.0 ↓ 8: 9.2 ↓ 9: 7.9 ↘ 10: 9.6 ↑
		Series 96 (3x)		Series 91 (2x)
		96 (3x)		187 (5x)
Series 3		1: 8.8 ↑ 2: 10.3 ↗ 3: 10.6x ↓ 4: 8.7 → 5: 9.6 ↗ 6: 10.0 ← 7: 9.3 ↓ 8: 9.8 ↗ 9: 10.4x ↗ 10: 10.5x ↗	Series 4	1: 9.2 ← 2: 9.8 ↗ 3: 10.2 → 4: 9.4 ↗ 5: 10.2 → 6: 9.7 ↗ 7: 10.3 ↘ 8: 10.8x → 9: 9.6 ← 10: 10.5x →
		Series 93 (3x)		Series 95 (2x)
		280 (8x)		375 (10x)
Series 5		1: 10.7x → 2: 10.1 ↑ 3: 9.3 → 4: 9.7 ↗ 5: 9.1 → 6: 10.1 ↓ 7: 9.0 ↘ 8: 9.9 ↗ 9: 10.8x ↗ 10: 9.9 ↗	Series 6	1: 10.8x ↖ 2: 10.4x ↘ 3: 8.4 ↓ 4: 9.6 ↗ 5: 9.7 ↓ 6: 10.0 ↗ 7: 9.8 ↗ 8: 9.3 ← 9: 10.0 ← 10: 9.9 ←
		Series 94 (2x)		Series 93 (2x)
		469 (12x)		562 (14x)

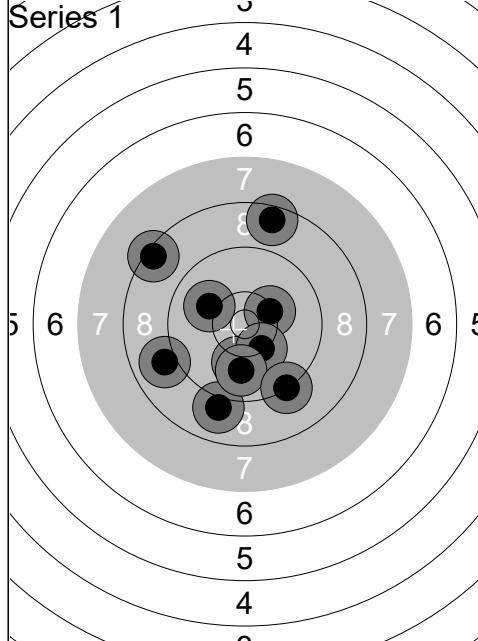

1: 10.3 →
2: 8.4 ↖
3: 9.0 ←
4: 10.1 ↓
5: 9.0 ↓
6: 10.3 ↓
7: 9.9 ↓
8: 9.3 ↓
9: 10.1 ↖
10: 8.5 ↑
Series 92 (0x)
92 (0x)

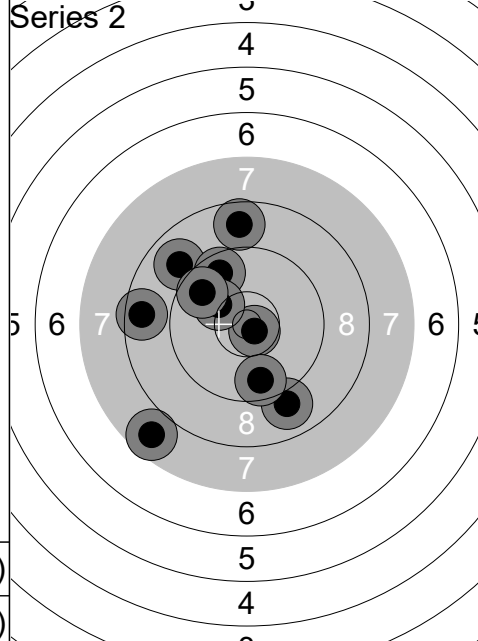

1: 8.6 ←
2: 8.9 ↗
3: 9.0 ↓
4: 10.7x ↘
5: 7.7 ↘
6: 9.6 ↗
7: 9.7 ↓
8: 10.2 ↖
9: 8.7 ↑
10: 9.7 ↖
Series 87 (1x)
179 (1x)

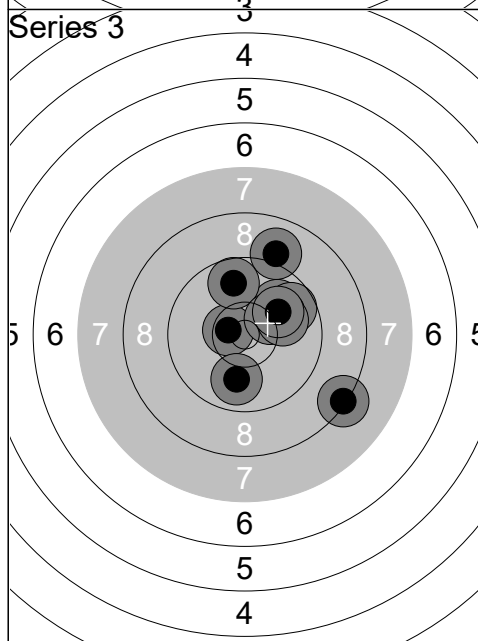

1: 10.0 ↗
2: 10.6x ←
3: 9.8 ↗
4: 8.3 ↘
5: 9.9 ↓
6: 9.0 ↑
7: 9.8 ↑
8: 10.3 ↗
9: 10.0 →
10: 10.1 ↗
Series 94 (1x)
273 (2x)

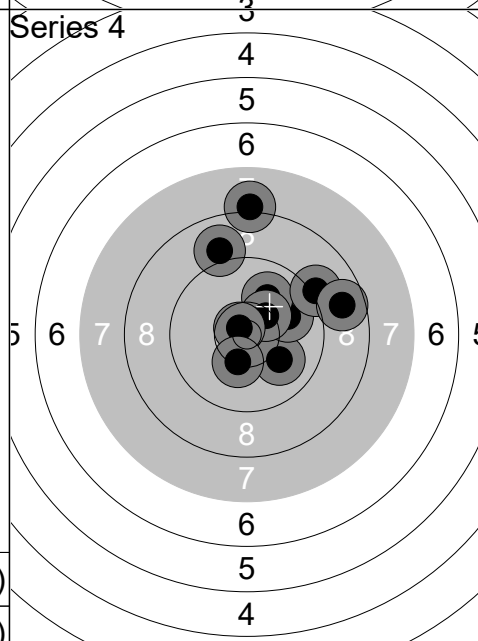

1: 10.0 ↘
2: 8.1 ↑
3: 10.0 →
4: 9.0 ↑
5: 10.0 ↗
6: 9.1 ↗
7: 10.4x ↗
8: 10.7x ↖
9: 10.3 ↓
10: 8.7 →
Series 94 (2x)
367 (4x)

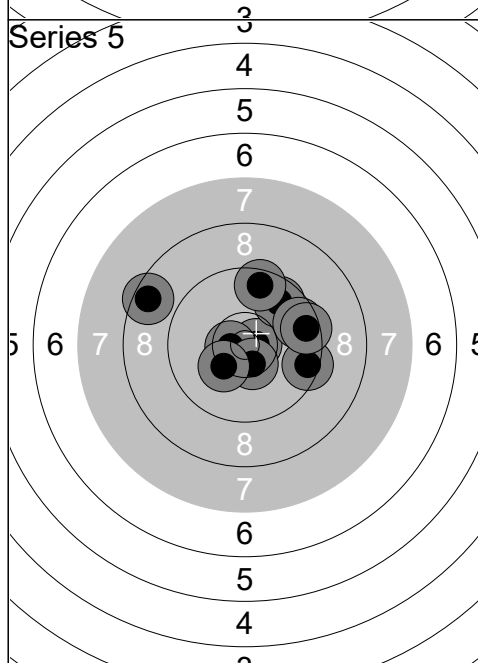

1: 10.7x →
2: 8.6 ←
3: 9.7 ↗
4: 10.6x ←
5: 10.5x ↓
6: 9.7 →
7: 9.5 →
8: 10.3 ↖
9: 9.5 →
10: 9.6 ↑
Series 93 (3x)
460 (7x)

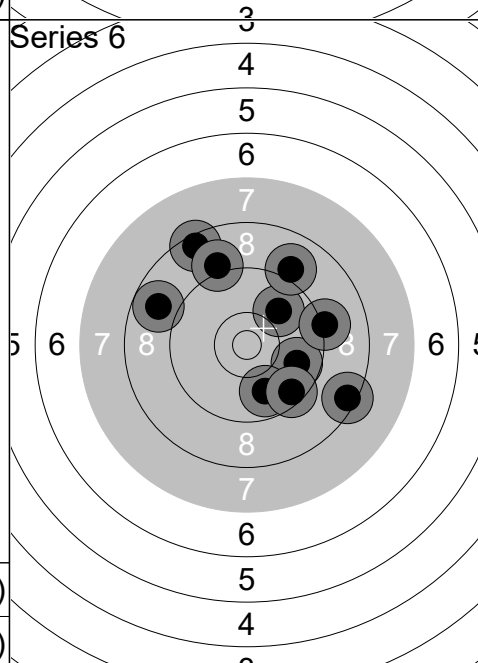

1: 8.4 ↘
2: 9.8 →
3: 9.8 ↓
4: 8.5 ↑
5: 9.9 ↗
6: 9.0 ↗
7: 8.8 ←
8: 9.1 ↑
9: 9.5 ↓
10: 9.2 →
Series 87 (0x)
547 (7x)

Relay	Lane	Johanna Reksten		
1	11	NOR	Wp	P
11.02.2026	Denmark Open Air 2026	Denmark Open Air 2026		
Series 1 	1: 9.2 ←	Series 2 	1: 9.6 ↙	
	2: 10.5x ↗		2: 10.7x ↘	
	3: 9.7 ↘		3: 9.4 ←	
	4: 10.0 ↘		4: 10.1 ↘	
	5: 9.4 ←		5: 9.2 ←	
	6: 10.5x ↘		6: 10.3 ↘	
	7: 10.7x →		7: 10.1 ↑	
	8: 10.3 ↘		8: 9.3 ↗	
	9: 8.2 ↘		9: 9.3 ↖	
	10: 10.3 ↘		10: 8.6 ↑	
	Series 95 (3x)		Series 93 (1x)	
	95 (3x)		188 (4x)	
Series 3 	1: 9.5 ←	Series 4 	1: 10.6x ↗	
	2: 9.0 ↖		2: 10.2 ↘	
	3: 10.6x ↗		3: 10.0 ↑	
	4: 10.3 ←		4: 10.4x →	
	5: 9.4 ↑		5: 10.7x ↑	
	6: 8.9 ↑		6: 9.1 ↑	
	7: 10.4x ↘		7: 10.7x ↑	
	8: 10.0 ↘		8: 8.7 ↘	
	9: 8.8 ↖		9: 9.8 ↑	
	10: 9.8 ↑		10: 7.2 ↘	
	Series 92 (2x)		Series 93 (4x)	
	280 (6x)		373 (10x)	
Series 5 	1: 10.0 →	Series 6 	1: 9.2 ↘	
	2: 9.6 ↘		2: 8.9 ↘	
	3: 9.6 ↗		3: 9.8 ↑	
	4: 10.1 ←		4: 10.4x ↙	
	5: 9.6 ↘		5: 10.5x ↗	
	6: 9.1 ↘		6: 10.1 ↗	
	7: 9.8 ←		7: 9.5 ↑	
	8: 9.7 ↑		8: 10.3 ↘	
	9: 9.6 ←		9: 9.6 ↙	
	10: 10.3 →		10: 10.6x ↘	
	Series 93 (0x)		Series 94 (3x)	
	466 (10x)		560 (13x)	

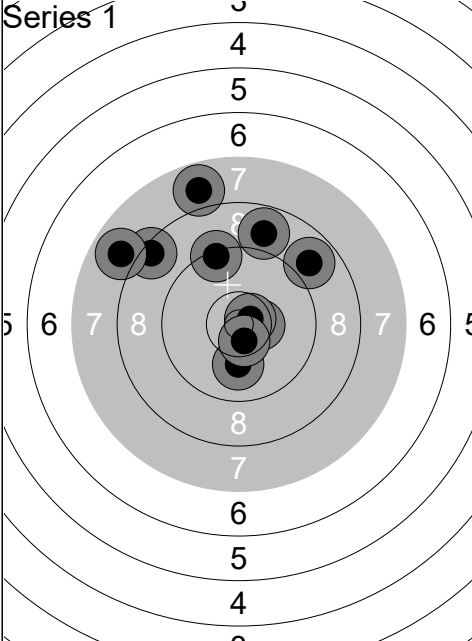
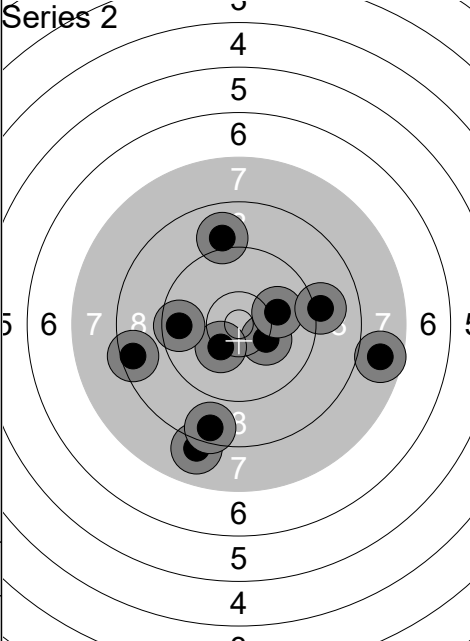
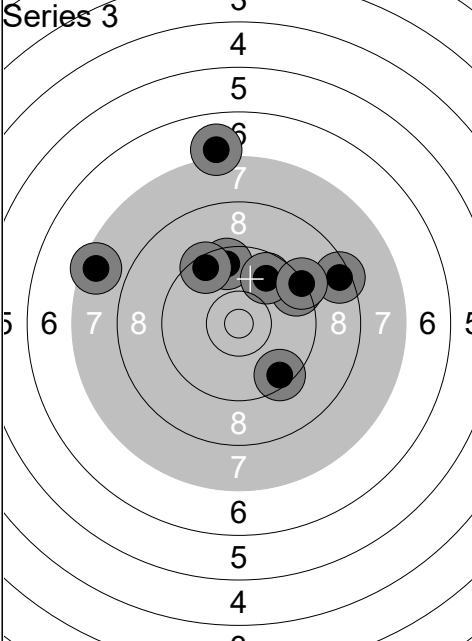
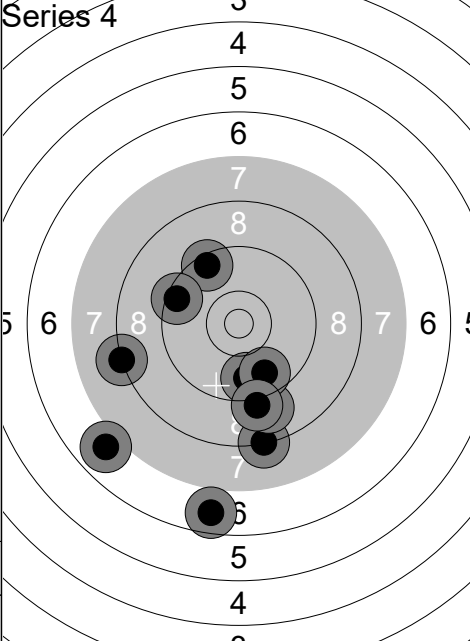
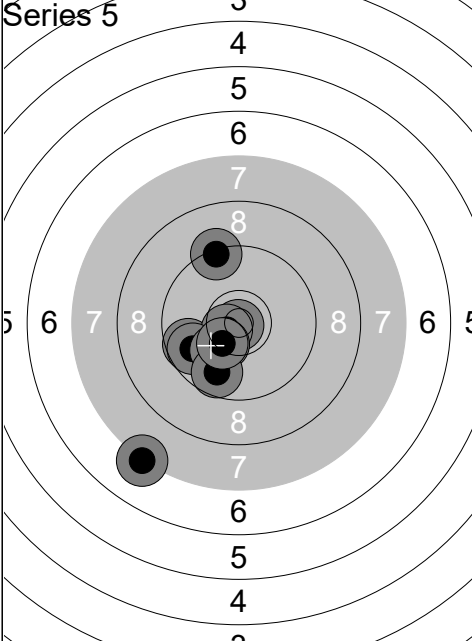
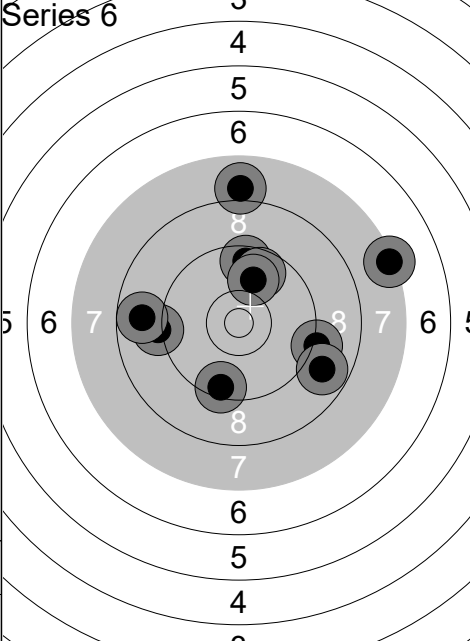
Relay	Lane	Katja Winther			
1	12	DEN	Wp	P	
Qual Day 1		Denmark Open Air 2026		Denmark Open Air 2026	
11.02.2026					
Series 1		1: 8.9 ↗	Series 2		1: 8.0 ↓
		2: 9.4 ↑			2: 7.7 →
		3: 10.0 ↓			3: 8.5 ↓
		4: 8.9 ↑			4: 10.3 ↘
		5: 10.5x →			5: 10.1 →
		6: 7.8 ↑			6: 8.5 ←
		7: 10.7x →			7: 10.3 ↓
		8: 8.4 ↖			8: 9.6 ←
		9: 7.9 ↖			9: 9.0 ↑
		10: 10.6x ↓			10: 9.1 →
		Series 87 (3x)			Series 88 (0x)
		87 (3x)			175 (3x)
Series 3		1: 7.0 ↑	Series 4		1: 9.5 ↗
		2: 9.3 ↗			2: 8.2 ↓
		3: 7.5 ↖			3: 9.5 ↖
		4: 9.5 ↗			4: 9.7 ↓
		5: 8.5 →			5: 9.0 ↓
		6: 9.6 ↑			6: 6.9 ↖
		7: 9.5 ↘			7: 9.7 ↓
		8: 9.8 ↑			8: 8.2 ←
		9: 9.3 ↗			9: 9.1 ↓
		10: 9.5 ↖			10: 6.7 ↓
		Series 85 (0x)			Series 82 (0x)
		260 (3x)			342 (3x)
Series 5		1: 10.9x ↓	Series 6		1: 9.6 ↑
		2: 9.7 ↖			2: 9.1 ←
		3: 7.2 ↓			3: 8.8 ←
		4: 10.7x ↖			4: 9.7 ↑
		5: 10.4x ↓			5: 9.5 ↓
		6: 9.8 ↖			6: 7.3 →
		7: 10.1 ↖			7: 9.9 ↑
		8: 9.8 ↓			8: 8.0 ↑
		9: 9.3 ↑			9: 9.1 →
		10: 10.4x ↘			10: 8.8 ↘
		Series 93 (4x)			Series 85 (0x)
		435 (7x)			520 (7x)

Relay	Lane	Line Nielsen	
1	13		
Qual Day 1	DEN	Wp	P
11.02.2026	Denmark Open Air 2026	Denmark Open Air 2026	
Series 1		1: 8.8 ↑ 2: 9.8 ← 3: 10.5x ↑ 4: 9.4 → 5: 9.4 → 6: 7.7 ↑ 7: 9.6 ↑ 8: 10.2 ↑ 9: 9.7 ↑ 10: 8.7 ↑ Series 88 (1x) 88 (1x)	Series 2
			1: 8.2 ↗ 2: 10.3 ← 3: 7.8 ← 4: 8.8 ↗ 5: 9.0 ↗ 6: 9.1 ↗ 7: 8.7 → 8: 6.6 ↑ 9: 9.1 ↑ 10: 8.2 → Series 82 (0x) 170 (1x)
Series 3		1: 6.1 → 2: 8.1 → 3: 7.9 → 4: 7.7 ← 5: 9.2 ↑ 6: 9.5 ↑ 7: 7.4 ↑ 8: 9.3 → 9: 9.9 → 10: 9.6 ↑ Series 80 (0x) 250 (1x)	Series 4
			1: 8.7 ← 2: 8.1 ↑ 3: 9.6 ↖ 4: 10.5x ↘ 5: 8.2 → 6: 10.3 ↖ 7: 8.8 ← 8: 10.0 ↙ 9: 9.7 ↑ 10: 10.1 ↗ Series 90 (1x) 340 (2x)
Series 5		1: 8.5 → 2: 6.7 ↘ 3: 10.1 ↑ 4: 10.7x ← 5: 8.7 ← 6: 9.6 ↙ 7: 9.0 ↑ 8: 9.9 ↑ 9: 10.4x ↑ 10: 10.2 ↗ Series 89 (2x) 429 (4x)	Series 6
			1: 9.6 ↘ 2: 9.3 → 3: 8.7 ↗ 4: 7.7 ↓ 5: 9.3 ↖ 6: 6.6 ← 7: 9.0 ↘ 8: 10.4x ↙ 9: 9.3 ↑ 10: 9.0 → Series 85 (1x) 514 (5x)

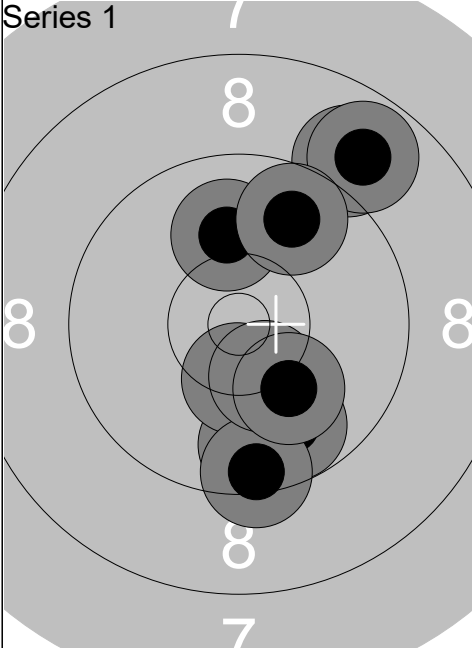
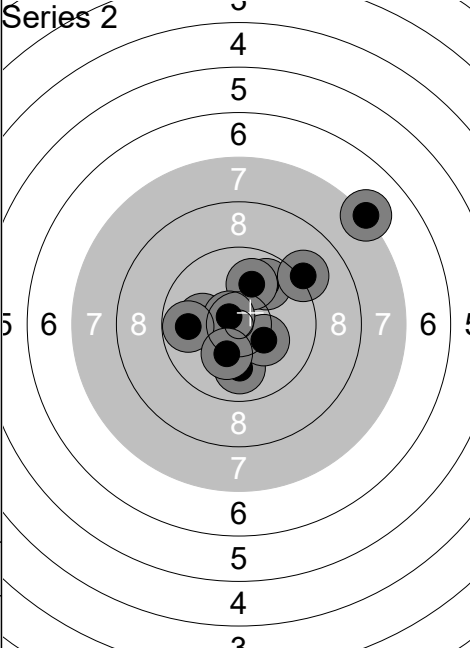
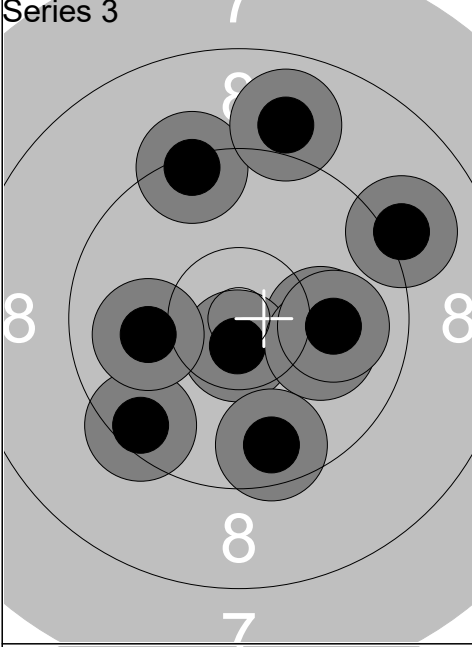
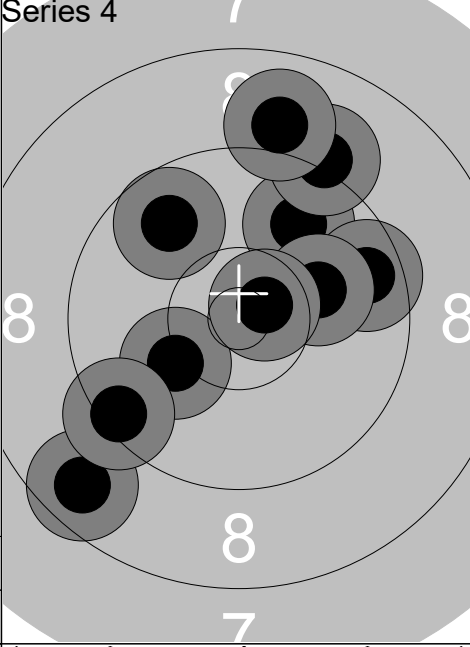
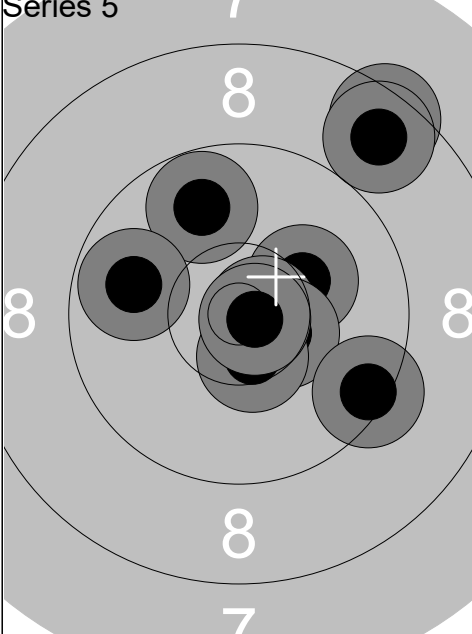
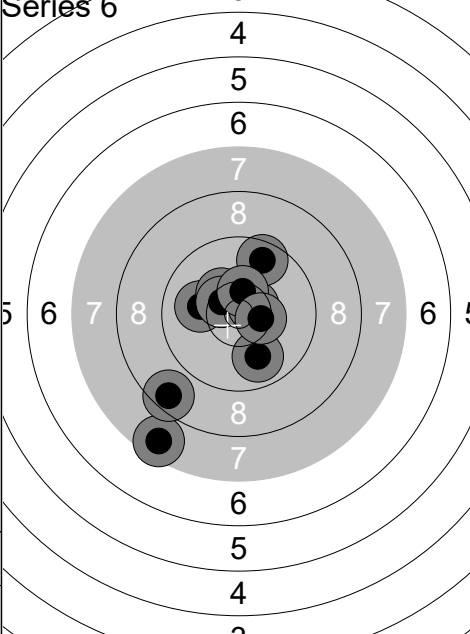
Relay	Lane	Louise Rasmussen		
1	14	DEN	Wp	P
Qual Day 1		Denmark Open Air 2026		Denmark Open Air 2026
11.02.2026				
Series 1 	1: 9.7 ↓	Series 2 	1: 9.9 ↗	
	2: 9.8 ↓		2: 10.1 ←	
	3: 10.4x ↓		3: 10.0 ↓	
	4: 9.5 ↓		4: 7.2 ↗	
	5: 10.0 ↑		5: 10.3 ↘	
	6: 9.0 ↗		6: 10.0 ↑	
	7: 8.8 ↗		7: 10.7x ↖	
	8: 10.4x ↓		8: 9.2 ↗	
	9: 10.1 ↓		9: 9.8 ←	
	10: 9.8 ↑		10: 10.2 ↓	
	Series 93 (2x)		Series 94 (1x)	
	93 (2x)		187 (3x)	
Series 3 	1: 9.4 ↑	Series 4 	1: 9.8 ↗	
	2: 9.5 ↙		2: 9.1 ↑	
	3: 8.9 ↑		3: 9.8 ↖	
	4: 9.1 ↗		4: 8.6 ↙	
	5: 10.1 →		5: 9.6 →	
	6: 10.7x ↓		6: 10.2 ↙	
	7: 10.1 →		7: 9.4 ↙	
	8: 10.0 ←		8: 10.1 →	
	9: 10.0 →		9: 9.0 ↑	
	10: 9.6 ↓		10: 10.7x ↗	
	Series 94 (1x)		Series 92 (1x)	
	281 (4x)		373 (5x)	
Series 5 	1: 9.8 ↑	Series 6 	1: 10.1 ←	
	2: 10.2 ↗		2: 7.6 ↙	
	3: 8.5 ↗		3: 10.4 ↖	
	4: 10.7x →		4: 8.5 ↙	
	5: 9.8 ←		5: 10.5x ↖	
	6: 10.5x →		6: 10.6x ↗	
	7: 10.5x ↓		7: 9.6 ↑	
	8: 8.7 ↗		8: 10.4x ↑	
	9: 9.4 ↘		9: 9.9 ↓	
	10: 10.8x →		10: 10.5x →	
	Series 93 (4x)		Series 93 (4x)	
	466 (9x)		559 (13x)	

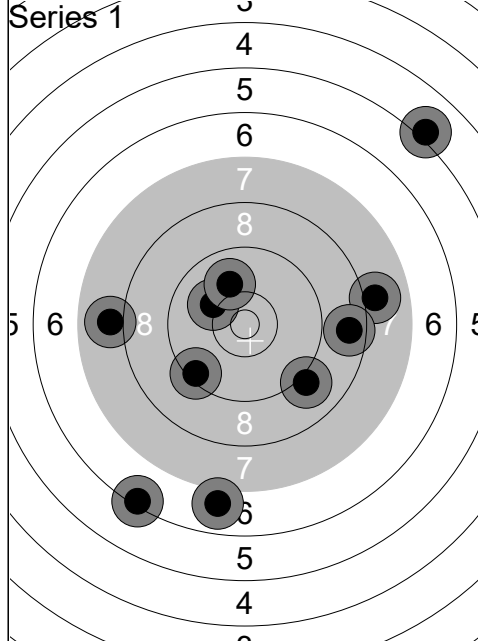

1: 10.1 ↖
2: 6.9 ↓
3: 8.0 →
4: 9.1 ↘
5: 7.9 ←
6: 5.1 ↗
7: 10.0 ↑
8: 8.6 →
9: 9.4 ↙
10: 6.3 ↓
Series 78 (0x)
78 (0x)

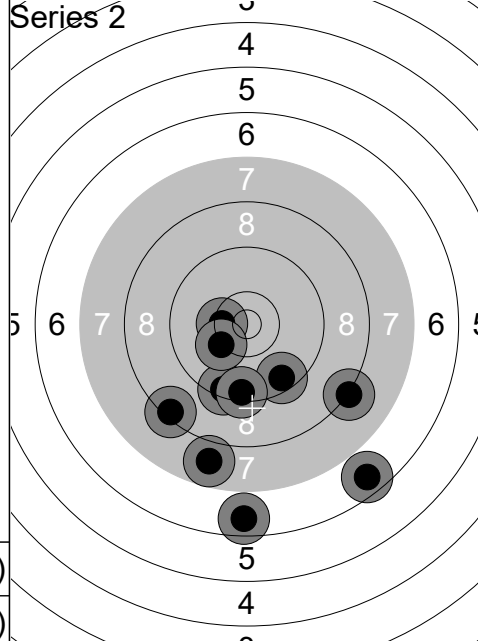

1: 8.2 ↘
2: 10.4x ←
3: 6.6 ↓
4: 9.4 ↘
5: 9.5 ↘
6: 7.8 ↓
7: 8.4 ↙
8: 6.6 ↘
9: 9.4 ↓
10: 10.2 ↙
Series 82 (1x)
160 (1x)

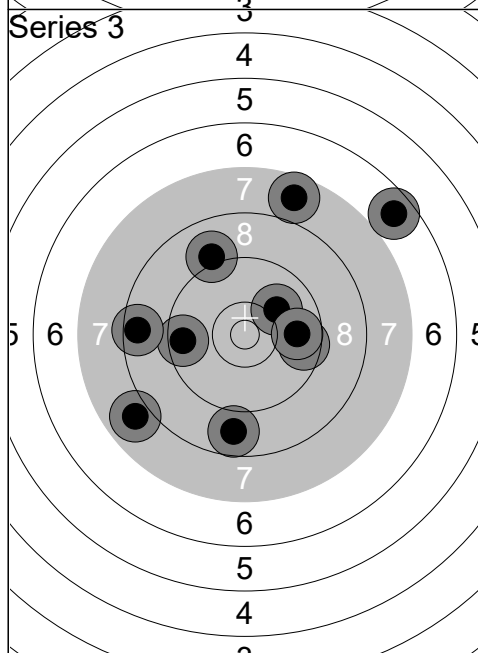

1: 8.8 ↓
2: 7.9 ↙
3: 9.1 ↑
4: 9.6 ←
5: 8.6 ←
6: 10.0 ↗
7: 7.7 ↑
8: 6.7 ↗
9: 9.6 →
10: 9.8 →
Series 82 (0x)
242 (1x)

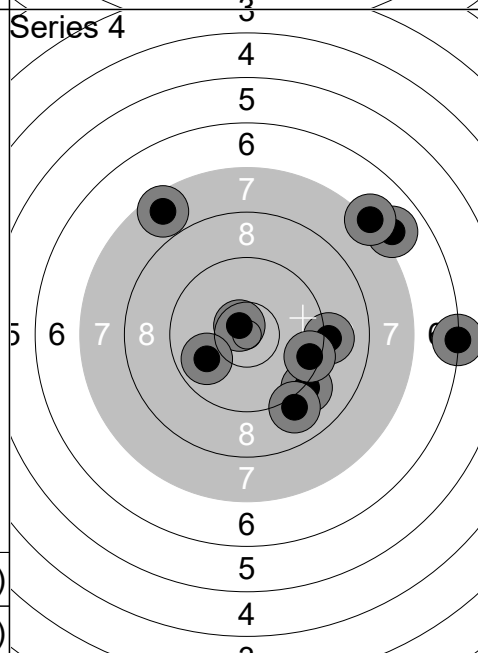

1: 9.2 ↘
2: 7.0 ↗
3: 7.2 ↗
4: 10.7x ↗
5: 9.0 ↓
6: 9.1 →
7: 7.6 ↗
8: 9.5 →
9: 6.2 →
10: 9.9 ↙
Series 82 (1x)
324 (2x)

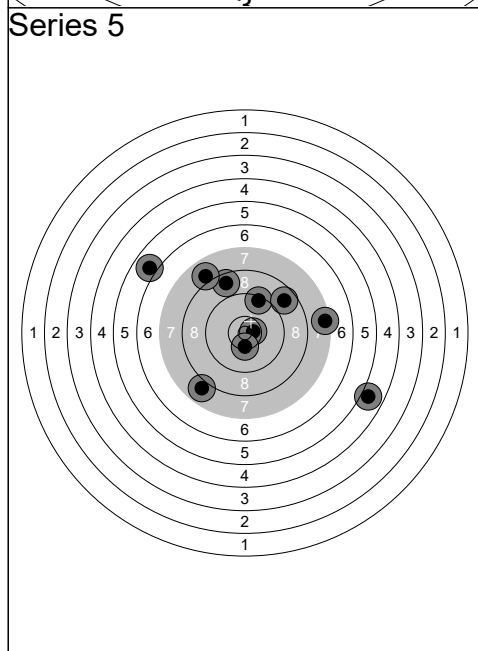

1: 7.9 ↘
2: 7.4 →
3: 5.9 ↖
4: 4.9 ↘
5: 10.6x →
6: 10.4x ↓
7: 9.4 ↑
8: 8.6 ↑
9: 8.7 ↗
10: 8.0 ↖
Series 76 (2x)
400 (4x)

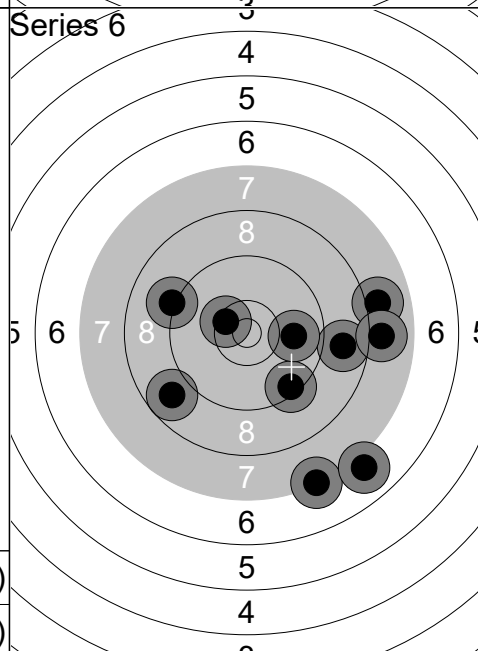

1: 7.3 ↓
2: 7.0 ↓
3: 8.8 →
4: 8.0 →
5: 8.8 ↙
6: 9.4 ↓
7: 10.4x ←
8: 9.2 ↖
9: 9.9 →
10: 8.0 →
Series 83 (1x)
483 (5x)

Relay	Lane	Mette Margrete		
Qual Day 1	DEN	Wp	P	
11.02.2026	Denmark Open Air 2026	Denmark Open Air 2026		
Series 1 	1: 9.3 ↘	Series 2 	1: 8.0 ←	
	2: 10.3 ↘		2: 9.9 ←	2: 9.9 ←
	3: 6.4 ←		3: 10.1 ↘	
	4: 9.7 ↗		4: 8.8 ↗	
	5: 9.2 ↗		5: 8.1 ↗	
	6: 7.6 ↘		6: 10.0 ←	
	7: 8.1 ↗		7: 9.2 ↗	
	8: 8.6 ↘		8: 6.3 ←	
	9: 8.2 ←		9: 8.1 →	
	10: 6.7 ↗		10: 8.5 ↘	
	Series 80 (0x)		Series 84 (0x)	
	80 (0x)		164 (0x)	
Series 3 	1: 9.8 ↗	Series 4 	1: 8.6 ←	
	2: 7.0 ↗		2: 9.6 ↗	2: 9.6 ↗
	3: 9.1 ↗		3: 6.6 ↗	
	4: 10.3 ↗		4: 9.4 ↗	
	5: 7.5 ←		5: 9.1 ←	
	6: 7.7 ↗		6: 8.9 ↗	
	7: 9.7 ↗		7: 10.1 →	
	8: 8.5 ↗		8: 10.1 ←	
	9: 10.8x ↘		9: 7.8 ↗	
	10: 8.7 ↗		10: 4.0 ↗	
	Series 84 (1x)		Series 80 (0x)	
	248 (1x)		328 (1x)	
Series 5 	1: 7.8 ←	Series 6 	1: 9.3 ↘	
	2: 8.0 ←		2: 8.4 ↗	2: 8.4 ↗
	3: 8.4 ↗		3: 8.3 ←	
	4: 10.2 →		4: 9.3 →	
	5: 7.9 ↗		5: 7.6 ↗	
	6: 5.8 ↘		6: 8.1 ↗	
	7: 7.0 ↗		7: 9.2 ↗	
	8: 8.5 ←		8: 8.6 ←	
	9: 9.2 ↗		9: 7.5 ↘	
	10: 9.3 ↘		10: 9.5 ↗	
	Series 78 (0x)		Series 82 (0x)	
	406 (1x)		488 (1x)	

Relay	Lane	Mette Renée Jensen			
1	17	DEN		Wp	P
11.02.2026		Denmark Open Air 2026		Denmark Open Air 2026	
Series 1 	1: 8.5 ↑	Series 2 	1: 10.4x ↑	Series 84 (1x)	Series 90 (2x)
	2: 7.0 ↘		2: 9.0 ↓		
	3: 9.2 ↗		3: 9.1 ↑		
	4: 9.4 ↖		4: 9.0 ↖		
	5: 8.6 ←		5: 10.1 →		
	6: 8.8 →		6: 7.7 ←		
	7: 9.2 ↗		7: 10.4x →		
	8: 8.8 ↑		8: 8.5 ↓		
	9: 10.5x ↓		9: 9.6 ←		
	10: 8.8 ↗		10: 9.3 ↓		
Series 84 (1x)		Series 90 (2x)		174 (3x)	
Series 3 	1: 8.9 ↑	Series 4 	1: 8.5 ↑	Series 88 (1x)	Series 90 (1x)
	2: 9.0 ←		2: 9.0 →		
	3: 8.8 →		3: 10.2 ↗		
	4: 9.1 →		4: 9.2 ←		
	5: 9.1 ↖		5: 8.7 ↖		
	6: 9.6 ↘		6: 9.6 ↑		
	7: 10.2 ↖		7: 10.8x ↓		
	8: 10.5x →		8: 9.2 ↓		
	9: 7.6 ↓		9: 9.5 ↑		
	10: 9.4 →		10: 9.5 ↗		
Series 88 (1x)		Series 90 (1x)		352 (5x)	
262 (4x)		352 (5x)			
Series 5 	1: 10.4x ↗	Series 6 	1: 9.4 →	Series 89 (3x)	Series 84 (1x)
	2: 8.4 ↑		2: 6.7 ↗		
	3: 10.3 ↑		3: 10.7x ↘		
	4: 8.6 →		4: 8.9 ↓		
	5: 10.7x ↖		5: 7.8 ↓		
	6: 8.7 ↖		6: 9.7 ↓		
	7: 7.6 ↗		7: 9.0 ↗		
	8: 10.4x ↗		8: 8.4 →		
	9: 9.0 ↓		9: 9.0 ↓		
	10: 9.3 ↓		10: 9.0 ↖		
Series 89 (3x)		Series 84 (1x)		525 (9x)	
441 (8x)		525 (9x)			

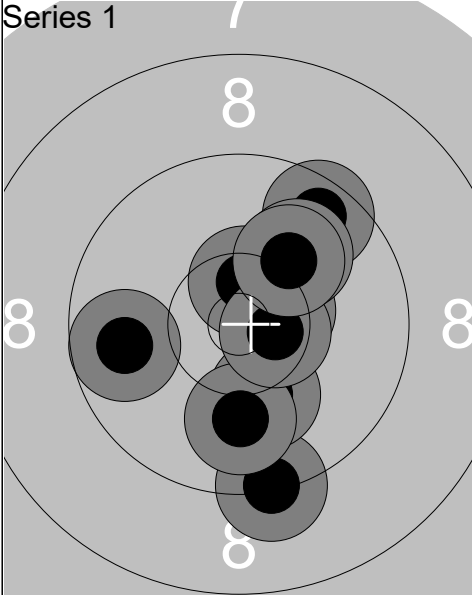
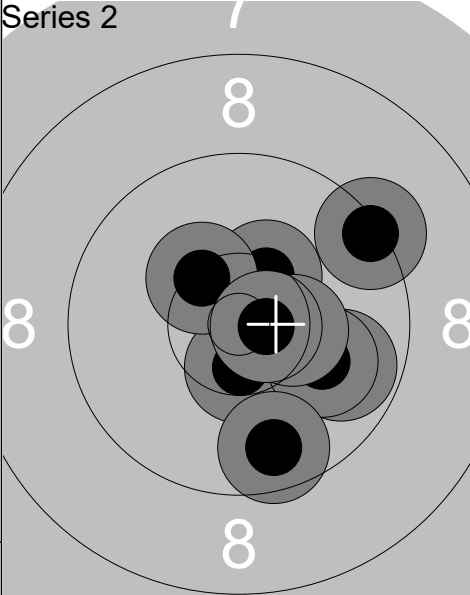
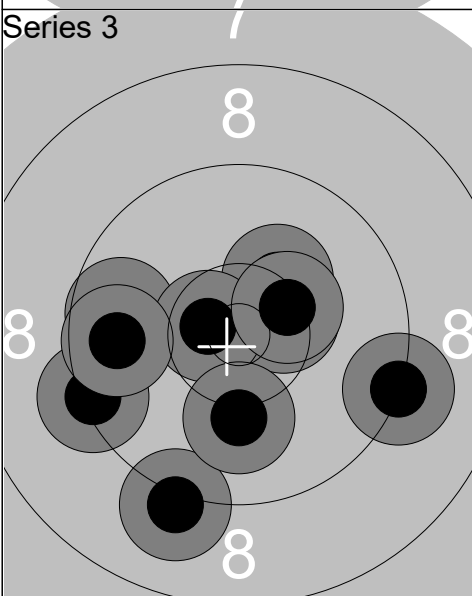
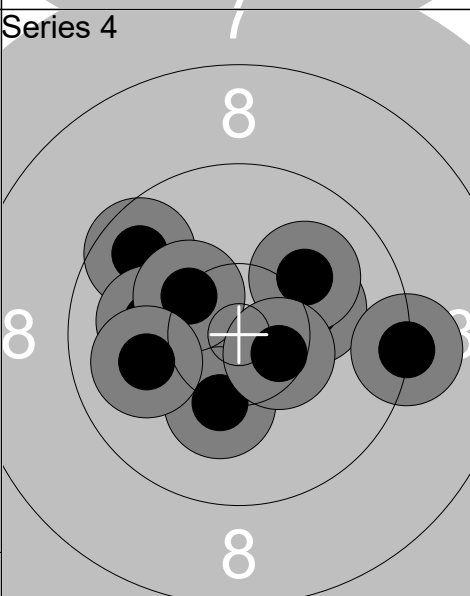
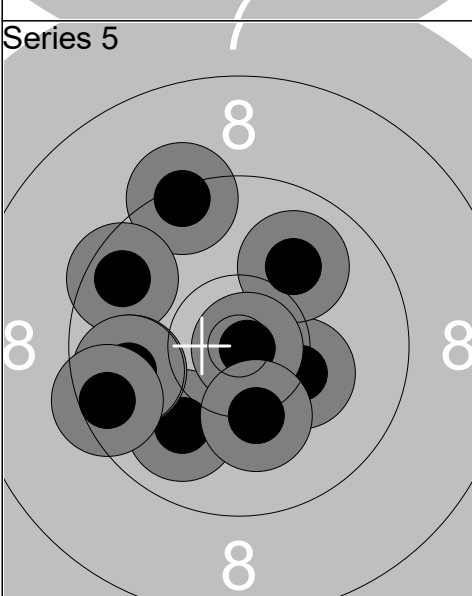
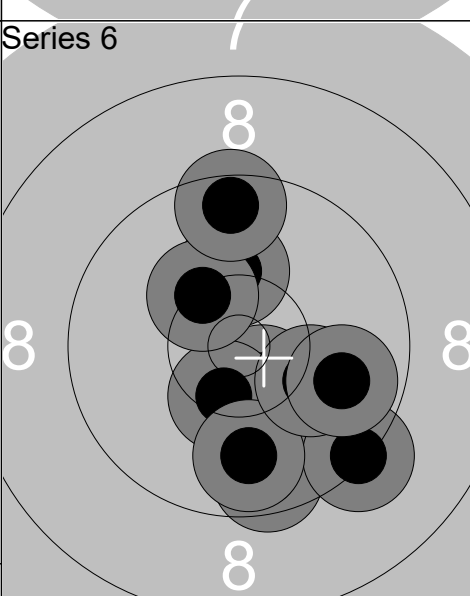
Relay	Lane	Sarah Tauermann		
1	18	GER	Wp	P
Qual Day 1		Denmark Open Air 2026		Denmark Open Air 2026
11.02.2026				
Series 1 	1: 9.6 ↗	Series 2 	1: 10.4x ↗	
	2: 10.5x →		2: 10.4x →	
	3: 9.3 ↓		3: 9.8 →	
	4: 9.8 ←		4: 10.5x ↓	
	5: 10.2 ↓		5: 10.4x ↗	
	6: 10.0 ↓		6: 9.3 ↗	
	7: 10.5x ↑		7: 10.0 →	
	8: 10.0 ↗		8: 10.4x →	
	9: 10.6x →		9: 9.7 ↓	
	10: 10.1 ↗		10: 10.7x →	
	Series 97 (3x)		Series 97 (6x)	
	97 (3x)		194 (9x)	
Series 3 	1: 9.7 ←	Series 4 	1: 10.4x ↓	
	2: 9.3 ←		2: 10.2 →	
	3: 10.3 ↗		3: 10.2 ↓	
	4: 10.5x →		4: 10.1 ↗	
	5: 10.6x ←		5: 9.7 ↗	
	6: 9.1 ↓		6: 9.3 →	
	7: 10.1 ↓		7: 10.1 ←	
	8: 9.7 ←		8: 10.3 ↗	
	9: 10.4x ↗		9: 10.5x →	
	10: 9.2 →		10: 10.0 ←	
	Series 95 (3x)		Series 98 (2x)	
	289 (12x)		387 (14x)	
Series 5 	1: 10.0 ↓	Series 6 	1: 10.5x ↓	
	2: 9.4 ↗		2: 9.6 ↓	
	3: 9.6 ↗		3: 10.4x ↓	
	4: 9.8 ←		4: 9.3 ↓	
	5: 10.3 →		5: 9.8 ↓	
	6: 9.8 ←		6: 10.2 →	
	7: 10.0 ↗		7: 10.2 ↑	
	8: 10.9x →		8: 9.9 →	
	9: 9.5 ←		9: 10.3 ↗	
	10: 10.2 ↓		10: 9.5 ↑	
	Series 95 (1x)		Series 95 (2x)	
	482 (15x)		577 (17x)	

Relay	Lane	Sofia Wern		Wp	P
1	19				
Qual Day 1		SWE			
11.02.2026		Denmark Open Air 2026		Denmark Open Air 2026	
Series 1		1: 9.2 ↓	Series 2		1: 8.6 ↘
		2: 6.5 ↑			2: 7.8 ↖
		3: 9.4 →			3: 9.6 ↗
		4: 9.5 ↑			4: 7.7 ↓
		5: 7.9 ↑			5: 8.0 ↓
		6: 8.5 ←			6: 10.5x ←
		7: 8.1 ←			7: 9.4 →
		8: 9.6 ↗			8: 8.5 ↗
		9: 10.2 ←			9: 6.9 ↓
		10: 10.1 ↗			10: 9.2 ↗
Series 85 (0x)		Series 81 (1x)		166 (1x)	
Series 3		1: 10.4x ↓	Series 4		1: 7.8 ↓
		2: 10.3 →			2: 8.5 ↘
		3: 8.3 ↑			3: 9.8 ↓
		4: 10.3 ↘			4: 6.5 ↘
		5: 8.4 ↑			5: 9.9 →
		6: 9.9 ↗			6: 6.5 ↑
		7: 9.1 ↖			7: 9.9 ↗
		8: 8.8 ↑			8: 7.2 ↑
		9: 8.5 ↗			9: 8.1 ↓
		10: 9.2 ↘			10: 10.8x ↘
Series 89 (1x)		Series 79 (1x)		334 (3x)	
255 (2x)		334 (3x)			
Series 5		1: 6.8 ←	Series 6		1: 9.6 ↘
		2: 7.7 ←			2: 9.8 ↘
		3: 9.1 ↑			3: 7.8 ↗
		4: 9.0 ↘			4: 9.4 ↗
		5: 5.8 →			5: 9.0 ←
		6: 9.6 →			6: 7.7 ↓
		7: 8.5 ↓			7: 8.2 ↘
		8: 9.3 ↓			8: 10.0 →
		9: 9.5 ↓			9: 7.5 ↗
		10: 9.4 ↘			10: 8.9 →
Series 80 (0x)		Series 83 (0x)		497 (3x)	
414 (3x)		497 (3x)			

Relay 1	Lane 20	Susanne Neisinger		
-------------------	-------------------	--------------------------	--	--

Qual Day 1	GER	Wp	P
------------	-----	----	---

11.02.2026	Denmark Open Air 2026	Denmark Open Air 2026
------------	-----------------------	-----------------------

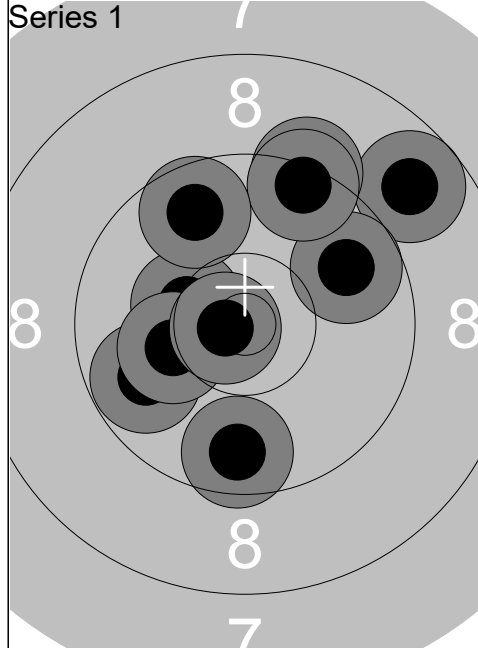

1:	10.3	←
2:	8.8	↗
3:	9.3	↗
4:	9.8	↗
5:	9.4	↗
6:	9.7	↖
7:	9.7	↓
8:	9.8	←
9:	10.2	←
10:	10.7x	←
Series	92 (1x)	
	92 (1x)	

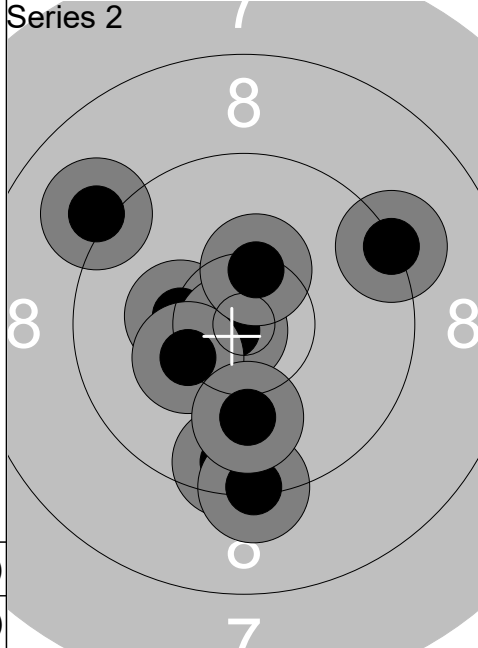

1:	10.3	←
2:	9.1	↖
3:	9.5	↓
4:	9.3	↓
5:	10.5x	↙
6:	10.8x	↙
7:	10.3	↙
8:	10.4x	↗
9:	10.0	↓
10:	9.3	↗
Series	96 (3x)	
	188 (4x)	

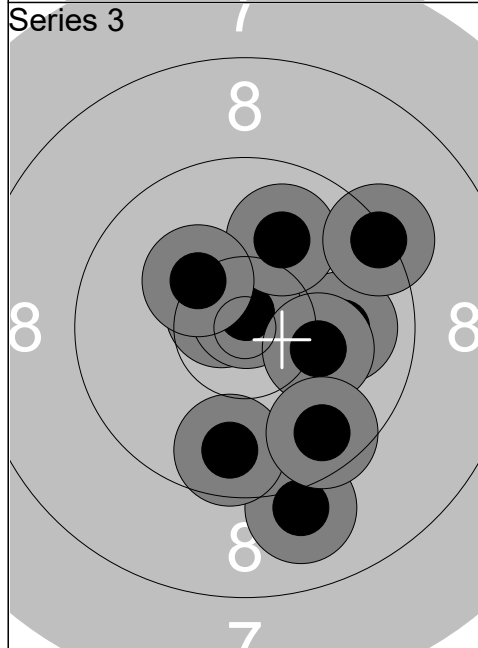

1:	10.0	→
2:	10.7x	↖
3:	10.8x	↗
4:	10.0	↗
5:	9.1	↓
6:	9.7	↓
7:	10.2	→
8:	10.3	↖
9:	9.3	↗
10:	9.6	↘
Series	96 (2x)	
	284 (6x)	

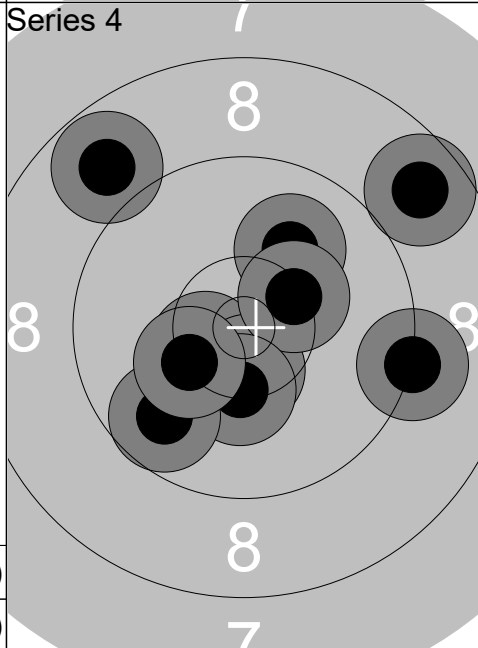

1:	10.0	↗
2:	10.5x	↙
3:	10.5x	↓
4:	10.4x	↗
5:	10.3	↓
6:	9.8	↙
7:	8.8	↖
8:	8.7	↗
9:	10.3	↙
10:	9.2	→
Series	94 (3x)	
	378 (9x)	

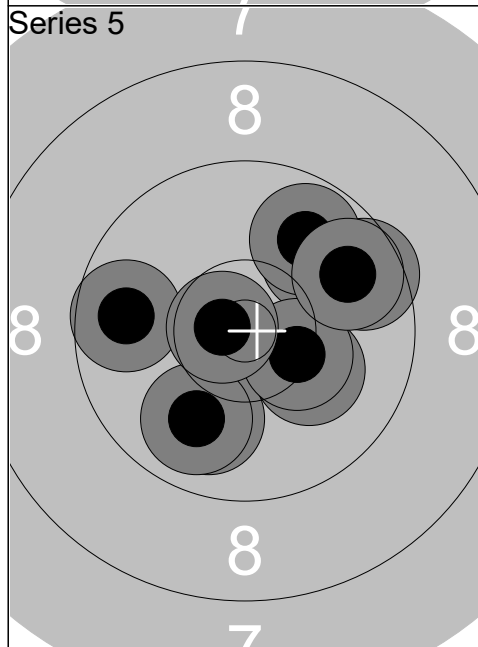

1:	10.0	↓
2:	9.9	↗
3:	10.2	↘
4:	9.7	←
5:	9.9	↓
6:	9.6	↗
7:	9.8	↗
8:	10.4x	↘
9:	9.8	↗
10:	10.7x	←
Series	94 (2x)	
	472 (11x)	

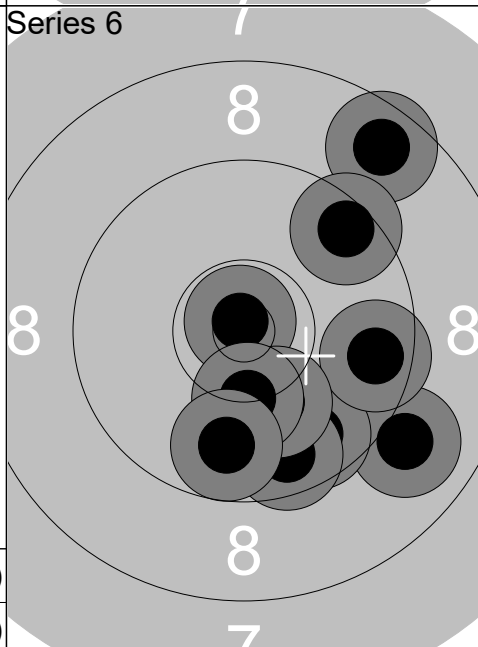

1:	9.0	↘
2:	9.7	↓
3:	9.6	↓
4:	9.6	→
5:	8.6	↗
6:	10.8x	↗
7:	10.2	↓
8:	10.3	↓
9:	9.8	↓
10:	9.5	↗
Series	92 (1x)	
	564 (12x)	