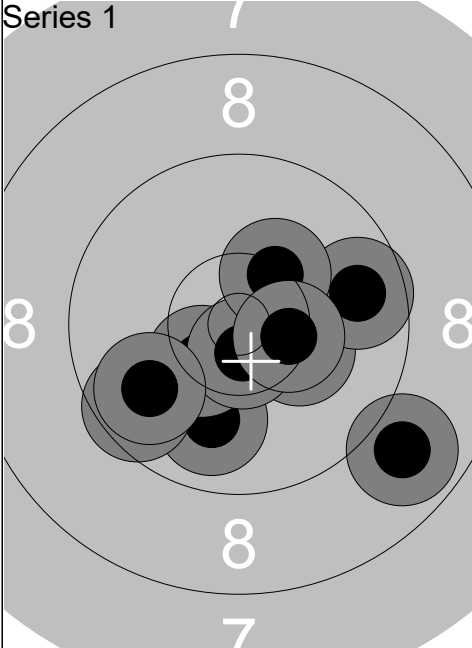
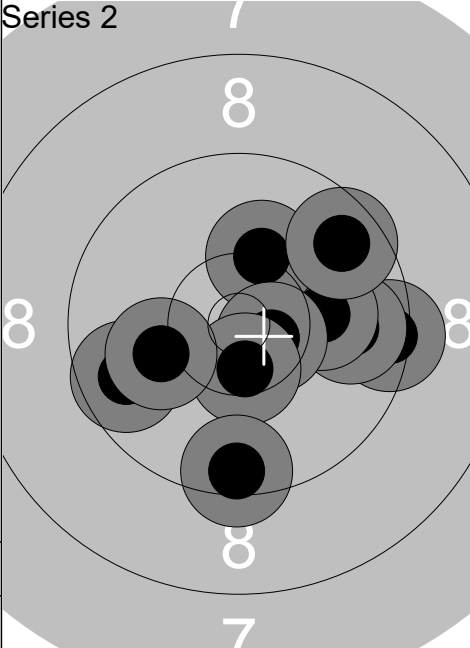
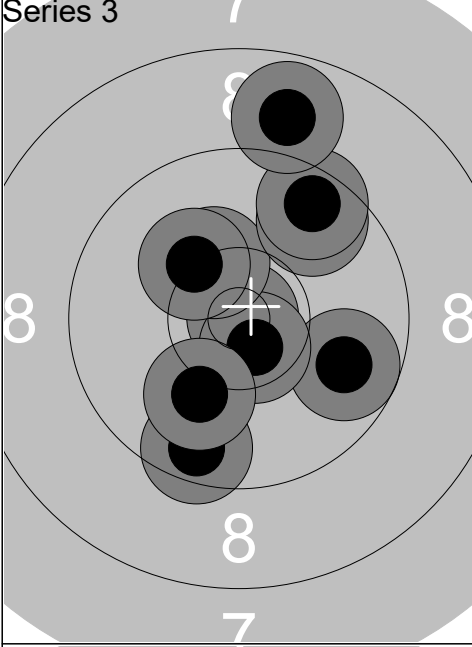
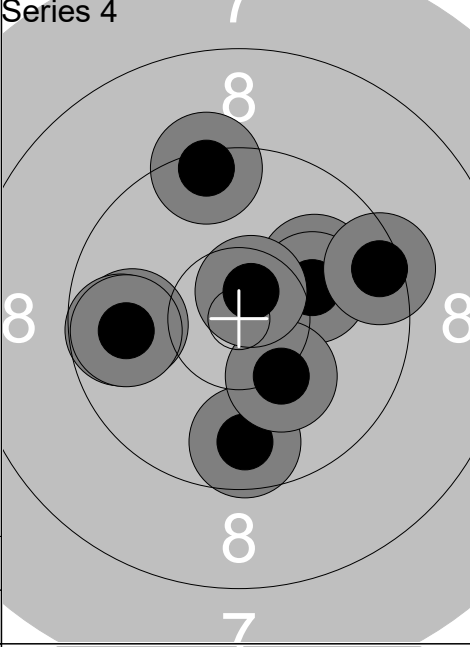
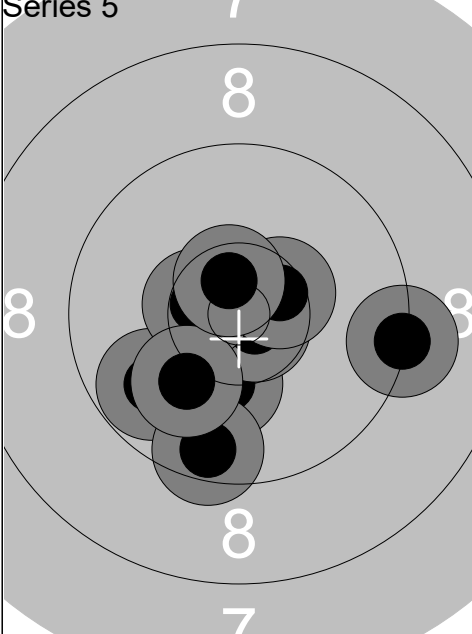
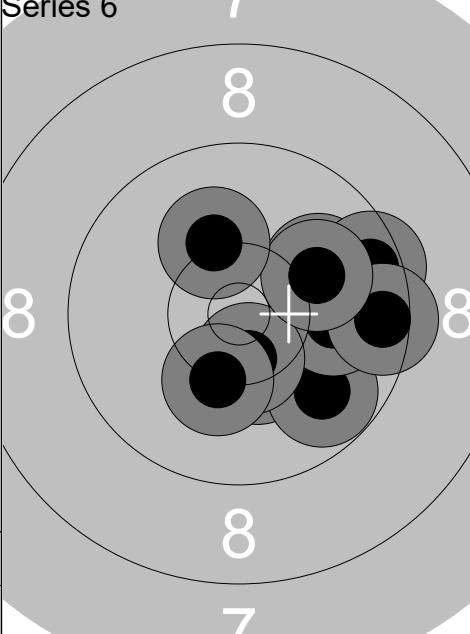
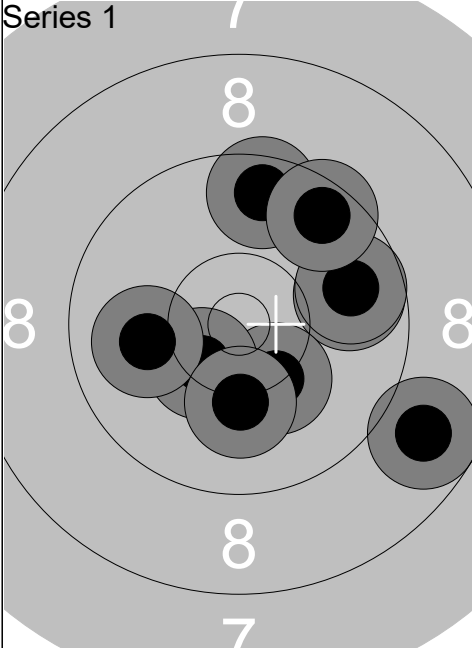
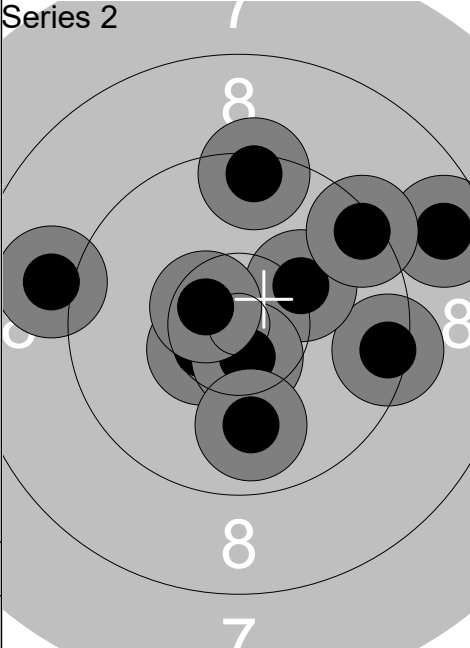
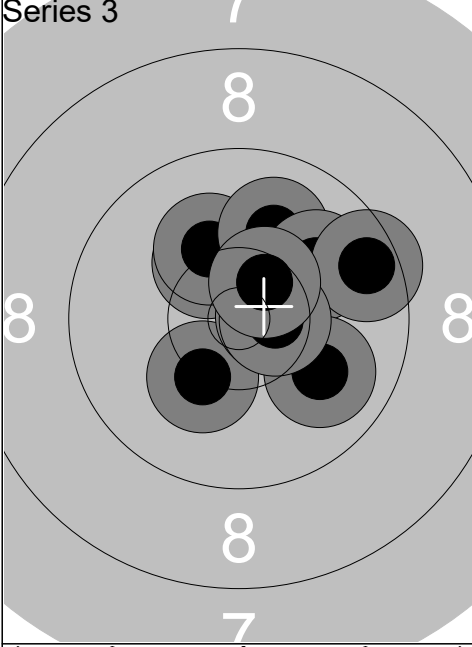
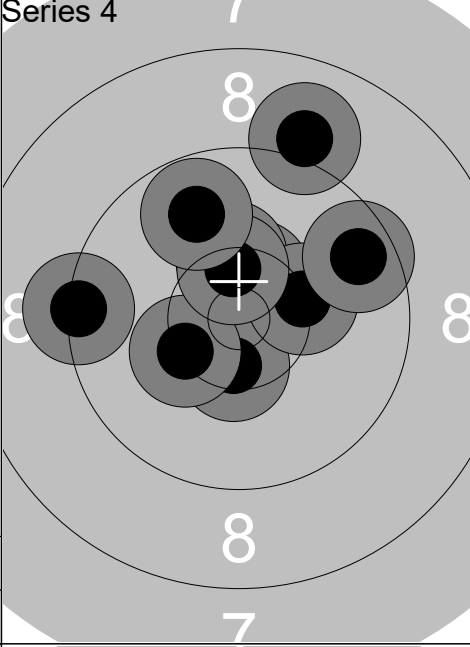
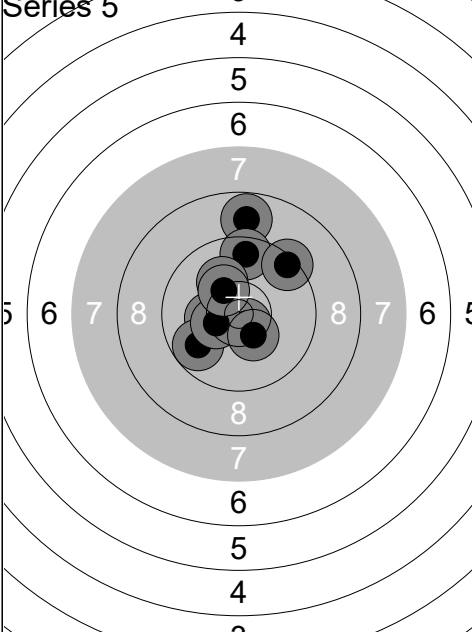
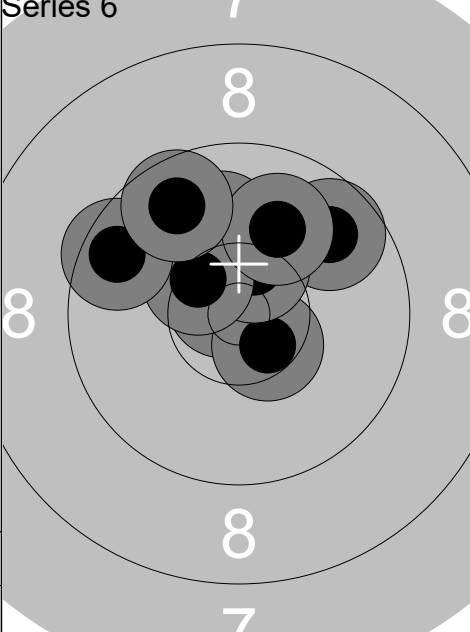

| Relay | Lane | Alex Fernan Peralta | | |
|------------|-----------------------|-----------------------|------------|--|
| Qual Day 3 | COL | Mp | P | |
| 11.02.2026 | Denmark Open Air 2026 | Denmark Open Air 2026 | | |
| | 1: 8.9 ↘ | | 1: 10.5x ↗ | |
| | 2: 10.2 ↓ | | 2: 10.7x ↙ | |
| | 3: 7.7 ↑ | | 3: 9.6 ↗ | |
| | 4: 9.8 → | | 4: 9.0 ↙ | |
| | 5: 9.4 ↗ | | 5: 9.8 ↑ | |
| | 6: 10.0 ↓ | | 6: 10.4x ↘ | |
| | 7: 10.6x ↘ | | 7: 9.7 ← | |
| | 8: 10.7x ↙ | | 8: 10.0 ↗ | |
| | 9: 10.5x ← | | 9: 9.9 ← | |
| | 10: 9.9 ↑ | | 10: 10.4 ↗ | |
| Series | 92 (3x) | Series | 95 (3x) | |
| | 92 (3x) | | 187 (6x) | |
| | 1: 10.3 ↓ | | 1: 9.3 ← | |
| | 2: 8.9 ↗ | | 2: 10.2 ↙ | |
| | 3: 9.3 ↑ | | 3: 10.7x ↘ | |
| | 4: 9.3 ↗ | | 4: 10.1 ↗ | |
| | 5: 9.9 ↑ | | 5: 8.8 ↗ | |
| | 6: 9.4 ↓ | | 6: 10.5x ↗ | |
| | 7: 10.3 ↗ | | 7: 10.0 ← | |
| | 8: 9.8 ↗ | | 8: 10.4x ↗ | |
| | 9: 8.9 → | | 9: 9.3 ↑ | |
| | 10: 10.3 ← | | 10: 9.5 ← | |
| Series | 91 (0x) | Series | 95 (3x) | |
| | 278 (6x) | | 373 (9x) | |
| | 1: 9.8 ↘ | | 1: 9.9 ↗ | |
| | 2: 9.9 ↓ | | 2: 8.6 ↑ | |
| | 3: 10.6x ↘ | | 3: 9.8 ↗ | |
| | 4: 8.9 ← | | 4: 10.0 ↑ | |
| | 5: 10.4x ↗ | | 5: 10.9x ↘ | |
| | 6: 8.9 ↑ | | 6: 9.3 ↑ | |
| | 7: 10.9x ↘ | | 7: 10.5x ↗ | |
| | 8: 10.7x ↑ | | 8: 10.1 → | |
| | 9: 10.4x ↑ | | 9: 10.1 → | |
| | 10: 10.2 ↗ | | 10: 9.6 ↗ | |
| Series | 94 (5x) | Series | 94 (2x) | |
| | 467 (14x) | | 561 (16x) | |

| Relay | Lane | Isac Ahlqvist | | |
|--|-----------------|--|-----------------|-----------------------|
| 5 | 4 | SWE | Mp | P |
| Qual Day 3 | | Denmark Open Air 2026 | | Denmark Open Air 2026 |
| 11.02.2026 | | | | |
| Series 1  | 1: 10.0 ↓ | Series 2  | 1: 9.4 → | |
| | 2: 10.3 → | | 2: 9.7 ← | |
| | 3: 9.6 ← | | 3: 9.8 → | |
| | 4: 10.4x ↙ | | 4: 10.1 → | |
| | 5: 10.7x ↓ | | 5: 10.2 ↑ | |
| | 6: 9.8 ← | | 6: 10.6x → | |
| | 7: 9.7 → | | 7: 10.5x ↓ | |
| | 8: 10.3 ↗ | | 8: 9.6 ↗ | |
| | 9: 8.9 ↘ | | 9: 10.1 ← | |
| | 10: 10.4x → | | 10: 9.5 ↓ | |
| | Series 95 (3x) | | Series 95 (2x) | |
| | 95 (3x) | | 190 (5x) | |
| Series 3  | 1: 10.9x → | Series 4  | 1: 9.9 ← | |
| | 2: 9.8 → | | 2: 9.7 ↓ | |
| | 3: 10.6x ↓ | | 3: 10.0 ↗ | |
| | 4: 9.6 ↓ | | 4: 10.2 → | |
| | 5: 10.3 ↗ | | 5: 9.8 ← | |
| | 6: 10.2 ↘ | | 6: 9.8 ← | |
| | 7: 9.7 ↗ | | 7: 9.5 → | |
| | 8: 9.6 ↗ | | 8: 10.2 ↘ | |
| | 9: 10.1 ↓ | | 9: 9.4 ↑ | |
| | 10: 8.9 ↑ | | 10: 10.7x ↗ | |
| | Series 94 (2x) | | Series 94 (1x) | |
| | 284 (7x) | | 378 (8x) | |
| Series 5  | 1: 9.8 ← | Series 6  | 1: 10.0 ↗ | |
| | 2: 10.7x ↘ | | 2: 10.4x ↓ | |
| | 3: 10.2 ↓ | | 3: 9.8 ↘ | |
| | 4: 10.7x ↘ | | 4: 10.0 → | |
| | 5: 9.5 ↓ | | 5: 10.5x ↓ | |
| | 6: 10.5x ← | | 6: 9.5 → | |
| | 7: 10.1 ↓ | | 7: 10.3 ↓ | |
| | 8: 10.5x → | | 8: 9.5 → | |
| | 9: 10.6x ↗ | | 9: 10.1 ↗ | |
| | 10: 9.3 → | | 10: 10.2 ↑ | |
| | Series 97 (5x) | | Series 97 (2x) | |
| | 475 (13x) | | 572 (15x) | |

| Relay | Lane | Leif Rasmussen | | | |
|---------------------|------------|-----------------------|------------|-----------------------|---|
| 5 | 5 | DEN | | Mp | P |
| 11.02.2026 | | Denmark Open Air 2026 | | Denmark Open Air 2026 | |
| Series 1 | 1: 9.9 ↙ | Series 2 | 1: 10.7x ↗ | | |
| | 2: 9.5 ↓ | | 2: 9.0 ↑ | | |
| | 3: 9.8 ↓ | | 3: 8.6 ↑ | | |
| | 4: 7.7 ↗ | | 4: 7.7 ← | | |
| | 5: 10.3 ↓ | | 5: 8.7 ↙ | | |
| | 6: 10.8x ↗ | | 6: 9.7 ↗ | | |
| | 7: 8.8 ← | | 7: 9.7 ↑ | | |
| | 8: 8.6 ↗ | | 8: 9.9 ← | | |
| | 9: 8.8 ↑ | | 9: 9.1 ↗ | | |
| | 10: 9.7 ↓ | | 10: 9.8 ↙ | | |
| Series 87 (1x) | | Series 87 (1x) | | | |
| 87 (1x) | | 174 (2x) | | | |
| Series 3 | 1: 9.8 ↗ | Series 4 | 1: 10.3 ↓ | | |
| | 2: 10.3 ↓ | | 2: 8.7 ↓ | | |
| | 3: 8.5 ← | | 3: 9.0 → | | |
| | 4: 10.2 ↗ | | 4: 9.9 ↗ | | |
| | 5: 8.8 ↓ | | 5: 8.7 ← | | |
| | 6: 10.3 → | | 6: 10.7x → | | |
| | 7: 8.9 ↗ | | 7: 10.4x ↗ | | |
| | 8: 8.0 ← | | 8: 8.1 ↗ | | |
| | 9: 9.2 ↑ | | 9: 8.4 ↓ | | |
| | 10: 9.3 ↘ | | 10: 9.6 ↙ | | |
| Series 89 (0x) | | Series 89 (2x) | | | |
| 263 (2x) | | 352 (4x) | | | |
| Series 5 | 1: 9.1 ← | Series 6 | 1: 10.3 ↓ | | |
| | 2: 8.8 ↗ | | 2: 8.7 ← | | |
| | 3: 8.4 → | | 3: 9.5 ↓ | | |
| | 4: 9.9 ← | | 4: 7.1 → | | |
| | 5: 10.6x ↙ | | 5: 9.4 ↗ | | |
| | 6: 9.3 ↓ | | 6: 10.4x ↙ | | |
| | 7: 9.0 ← | | 7: 8.7 ← | | |
| | 8: 9.2 ← | | 8: 8.4 ↗ | | |
| | 9: 9.4 ← | | 9: 8.8 ↓ | | |
| | 10: 8.9 → | | 10: 9.0 ↙ | | |
| Series 88 (1x) | | Series 86 (1x) | | | |
| 440 (5x) | | 526 (6x) | | | |

| Relay | Lane | Nicklas Kildehøj | | |
|------------|------------|-----------------------|-------------|-----------------------|
| 5 | 6 | DEN | Mp | P |
| Qual Day 3 | | Denmark Open Air 2026 | | Denmark Open Air 2026 |
| 11.02.2026 | | | | |
| | 1: 9.6 ↘ | | 1: 10.7x ↑ | |
| | 2: 8.8 ↗ | | 2: 9.8 ↓ | |
| | 3: 10.5x ↖ | | 3: 9.3 ↓ | |
| | 4: 10.8x → | | 4: 10.6x → | |
| | 5: 10.0 ↖ | | 5: 9.6 → | |
| | 6: 10.6x ← | | 6: 8.4 ↗ | |
| | 7: 10.3 ↓ | | 7: 10.3 → | |
| | 8: 8.8 ↓ | | 8: 10.3 ↙ | |
| | 9: 8.8 ↑ | | 9: 8.9 ↓ | |
| | 10: 10.0 → | | 10: 9.3 ↑ | |
| Series | 93 (3x) | Series | 92 (2x) | |
| | 93 (3x) | | 185 (5x) | |
| | 1: 9.2 ← | | 1: 9.5 ↓ | |
| | 2: 8.9 ↓ | | 2: 10.5x ↖ | |
| | 3: 8.8 ↙ | | 3: 9.5 ↓ | |
| | 4: 9.0 ← | | 4: 9.2 ← | |
| | 5: 9.3 → | | 5: 9.4 ↓ | |
| | 6: 9.1 ← | | 6: 9.8 ↙ | |
| | 7: 10.8x ↙ | | 7: 10.6x ↙ | |
| | 8: 9.7 → | | 8: 10.1 ↖ | |
| | 9: 9.0 ↑ | | 9: 10.7x ↑ | |
| | 10: 9.6 ↗ | | 10: 10.1 ↑ | |
| Series | 89 (1x) | Series | 95 (3x) | |
| | 274 (6x) | | 369 (9x) | |
| | 1: 8.2 ↗ | | 1: 10.5x → | |
| | 2: 8.2 ↑ | | 2: 10.6x ↑ | |
| | 3: 9.9 ↗ | | 3: 10.5x → | |
| | 4: 9.2 ↗ | | 4: 8.0 ↓ | |
| | 5: 9.5 ↓ | | 5: 9.8 → | |
| | 6: 10.4x ↗ | | 6: 10.6x ↖ | |
| | 7: 9.2 ← | | 7: 9.3 ↗ | |
| | 8: 9.6 ↓ | | 8: 8.8 → | |
| | 9: 8.9 → | | 9: 10.1 ← | |
| | 10: 7.4 ← | | 10: 10.4x → | |
| Series | 86 (1x) | Series | 94 (5x) | |
| | 455 (10x) | | 549 (15x) | |

| Relay | Lane | Paul Fröhlich | | |
|------------|--|-----------------------|--|-----------------------|
| 5 | 7 | GER | Mp | P |
| Qual Day 3 | | Denmark Open Air 2026 | | Denmark Open Air 2026 |
| 11.02.2026 | | Denmark Open Air 2026 | | Denmark Open Air 2026 |
| Series 1 |  | 1: 10.2 ↓ | Series 2 | 1: 10.5x ↘ |
| | | 2: 9.8 → |  | 2: 9.4 → |
| | | 3: 10.3 ↘ | | 3: 9.4 ↑ |
| | | 4: 9.8 → | | 4: 10.2 ↗ |
| | | 5: 10.4x ↘ | | 5: 10.6x ↓ |
| | | 6: 8.8 → | | 6: 10.6x ↖ |
| | | 7: 10.0 ← | | 7: 9.0 ← |
| | | 8: 9.6 ↑ | | 8: 8.7 → |
| | | 9: 9.6 ↗ | | 9: 9.4 ↗ |
| | | 10: 10.2 ↓ | | 10: 9.9 ↓ |
| | | Series 94 (1x) | | Series 93 (3x) |
| | | 94 (1x) | | 187 (4x) |
| Series 3 |  | 1: 10.3 ↖ | Series 4 | 1: 10.5x ↑ |
| | | 2: 10.3 ↘ |  | 2: 10.5x ↓ |
| | | 3: 10.2 ↖ | | 3: 10.3 ↑ |
| | | 4: 10.0 ↑ | | 4: 10.3 ← |
| | | 5: 10.0 ↗ | | 5: 10.3 → |
| | | 6: 10.6x → | | 6: 9.0 ↑ |
| | | 7: 9.5 → | | 7: 10.5x ↑ |
| | | 8: 10.0 ↘ | | 8: 9.8 ↑ |
| | | 9: 10.6x → | | 9: 9.3 ← |
| | | 10: 10.5x ↗ | | 10: 9.6 ↗ |
| | | Series 99 (3x) | | Series 96 (3x) |
| | | 286 (7x) | | 382 (10x) |
| Series 5 |  | 1: 8.8 ↑ | Series 6 | 1: 10.5x ↑ |
| | | 2: 10.3 ← |  | 2: 10.7x ↖ |
| | | 3: 9.8 ↘ | | 3: 9.7 ↗ |
| | | 4: 10.7x ↘ | | 4: 10.5x ↘ |
| | | 5: 9.6 ↑ | | 5: 10.4x ↑ |
| | | 6: 10.4x ↖ | | 6: 10.1 ↑ |
| | | 7: 10.2 ↖ | | 7: 10.4x ↖ |
| | | 8: 10.4x ↘ | | 8: 9.6 ↖ |
| | | 9: 9.4 ↗ | | 9: 10.0 ↑ |
| | | 10: 10.3 ↖ | | 10: 9.7 ↖ |
| | | Series 95 (3x) | | Series 97 (5x) |
| | | 477 (13x) | | 574 (18x) |

| Relay | Lane | Tjark Buchwald | | |
|------------|-----------------------|--|-------------------------------|---|
| 5 | 8 | GER | Mp | P |
| 11.02.2026 | Denmark Open Air 2026 | Denmark Open Air 2026 | | |
| Series 1 | | 1: 9.6 ↑ 2: 10.2 ↙ 3: 8.9 ↓ 4: 10.3 ← 5: 9.3 ← 6: 10.0 ↑ 7: 10.8x ↓ 8: 9.8 → 9: 10.2 ↗ 10: 9.0 ← | Series 94 (1x) 94 (1x) | |
| Series 2 | | 1: 10.5x ↖ 2: 8.6 ↙ 3: 10.0 ↓ 4: 9.7 → 5: 9.6 ↓ 6: 9.8 ↙ 7: 10.5x ↗ 8: 8.6 ↑ 9: 9.8 ↑ 10: 9.5 ↖ | Series 91 (2x) 185 (3x) | |
| Series 3 | | 1: 10.7x ↑ 2: 10.3 ↖ 3: 10.5x ↓ 4: 8.1 ↑ 5: 9.1 ← 6: 10.4x ← 7: 10.2 ↙ 8: 8.3 ↗ 9: 9.5 ↑ 10: 10.4 ↗ | Series 94 (3x) 279 (6x) | |
| Series 4 | | 1: 9.9 ← 2: 9.6 ↖ 3: 10.7x → 4: 9.8 ↑ 5: 8.9 ↓ 6: 9.8 ↗ 7: 10.6x ↖ 8: 10.3 ↑ 9: 10.1 → 10: 9.7 → | Series 93 (2x) 372 (8x) | |
| Series 5 | | 1: 8.7 ↑ 2: 10.6x ↖ 3: 9.8 ↗ 4: 9.9 ↗ 5: 8.6 ↑ 6: 10.0 → 7: 9.8 ↓ 8: 9.8 ↗ 9: 10.7x ↖ 10: 9.8 ↓ | Series 91 (2x) 463 (10x) | |
| Series 6 | | 1: 10.1 → 2: 8.9 ↑ 3: 10.0 → 4: 10.2 ↑ 5: 9.4 ↓ 6: 10.3 ↑ 7: 10.3 ↓ 8: 10.5x → 9: 8.6 ↓ 10: 10.4 ← | Series 95 (1x) 558 (11x) | |

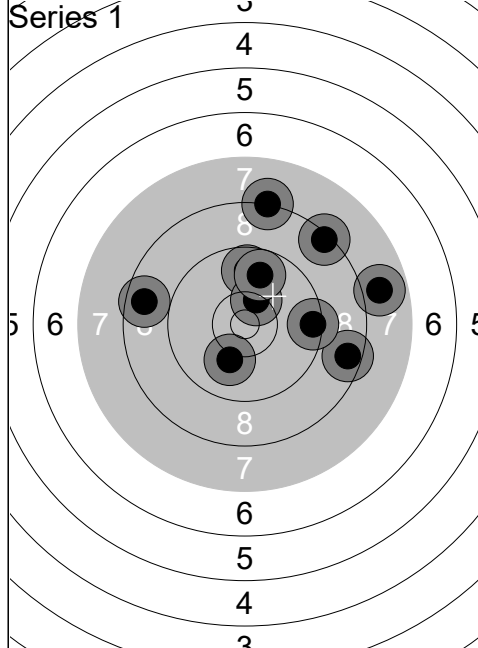

| | | |
|---------------|-----------------|---|
| 1: | 8.6 | ← |
| 2: | 9.7 | ↑ |
| 3: | 8.2 | ↑ |
| 4: | 8.5 | → |
| 5: | 10.4 | ↗ |
| 6: | 9.4 | → |
| 7: | 10.1 | ↓ |
| 8: | 8.4 | ↗ |
| 9: | 7.9 | → |
| 10: | 9.8 | ↑ |
| Series | 86 (0x) | |
| | 86 (0x) | |

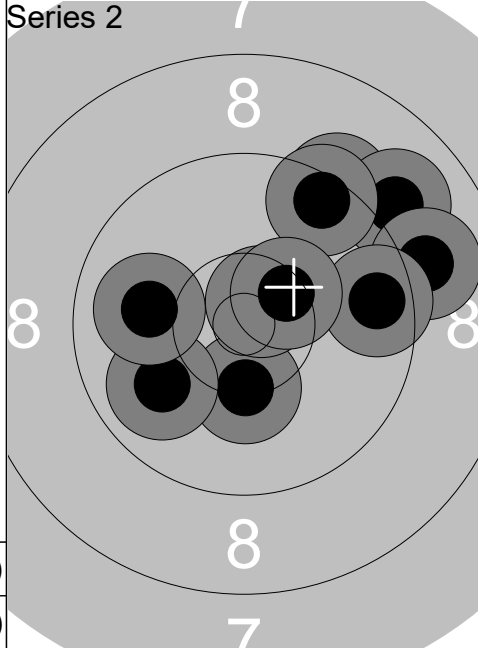

| | | |
|---------------|------------------|---|
| 1: | 10.3 | ↓ |
| 2: | 10.7x | ↗ |
| 3: | 9.9 | ↙ |
| 4: | 9.3 | ↗ |
| 5: | 9.0 | ↗ |
| 6: | 9.0 | → |
| 7: | 9.5 | ↗ |
| 8: | 10.0 | ← |
| 9: | 9.6 | → |
| 10: | 10.4x | ↗ |
| Series | 94 (2x) | |
| | 180 (2x) | |

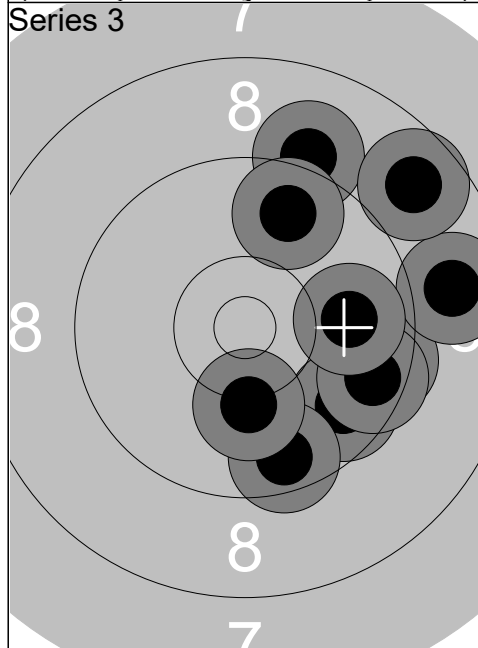

| | | |
|---------------|------------------|---|
| 1: | 9.7 | ↘ |
| 2: | 9.1 | ↑ |
| 3: | 9.5 | → |
| 4: | 9.6 | → |
| 5: | 9.7 | ↑ |
| 6: | 9.6 | ↓ |
| 7: | 8.8 | → |
| 8: | 9.9 | → |
| 9: | 8.7 | ↗ |
| 10: | 10.2 | ↓ |
| Series | 89 (0x) | |
| | 269 (2x) | |

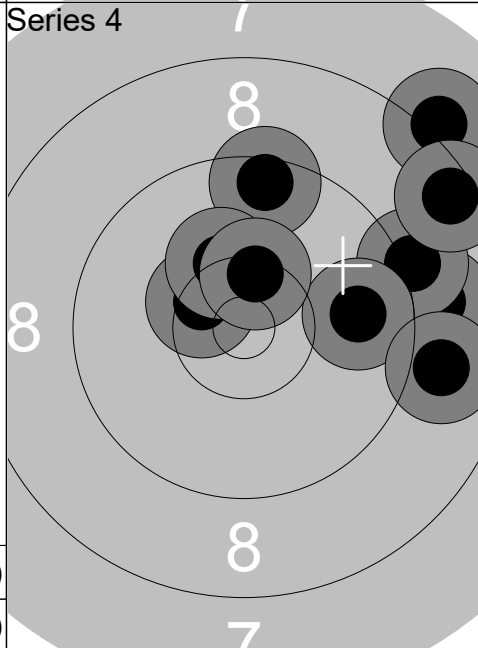

| | | |
|---------------|------------------|---|
| 1: | 9.0 | → |
| 2: | 10.5x | ↖ |
| 3: | 9.5 | ↑ |
| 4: | 9.1 | → |
| 5: | 10.3 | ↑ |
| 6: | 9.8 | → |
| 7: | 10.4x | ↑ |
| 8: | 8.9 | → |
| 9: | 8.1 | ↗ |
| 10: | 8.5 | ↗ |
| Series | 90 (2x) | |
| | 359 (4x) | |

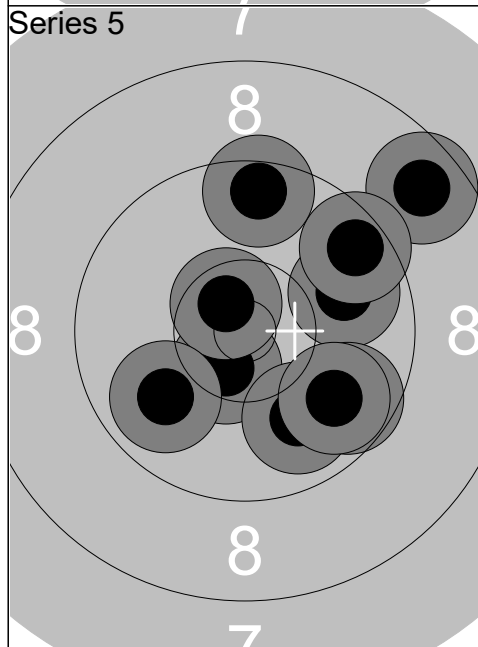

| | | |
|---------------|------------------|---|
| 1: | 10.5x | ↓ |
| 2: | 10.6x | ↖ |
| 3: | 9.9 | ↙ |
| 4: | 9.9 | → |
| 5: | 9.9 | ↓ |
| 6: | 8.7 | ↗ |
| 7: | 9.6 | ↗ |
| 8: | 9.7 | ↘ |
| 9: | 9.5 | ↑ |
| 10: | 9.8 | ↘ |
| Series | 91 (2x) | |
| | 450 (6x) | |

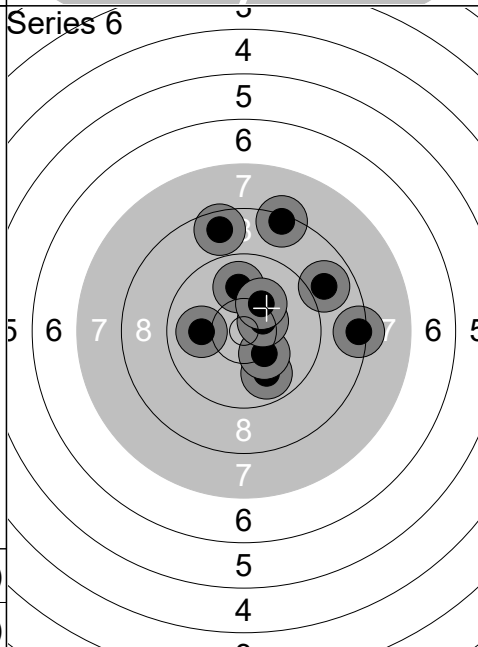

| | | |
|---------------|------------------|---|
| 1: | 9.9 | ↓ |
| 2: | 8.4 | ↑ |
| 3: | 10.3 | ↘ |
| 4: | 8.4 | → |
| 5: | 10.0 | ← |
| 6: | 10.5x | ↗ |
| 7: | 10.0 | ↑ |
| 8: | 8.9 | ↗ |
| 9: | 10.2 | ↗ |
| 10: | 8.6 | ↑ |
| Series | 91 (1x) | |
| | 541 (7x) | |

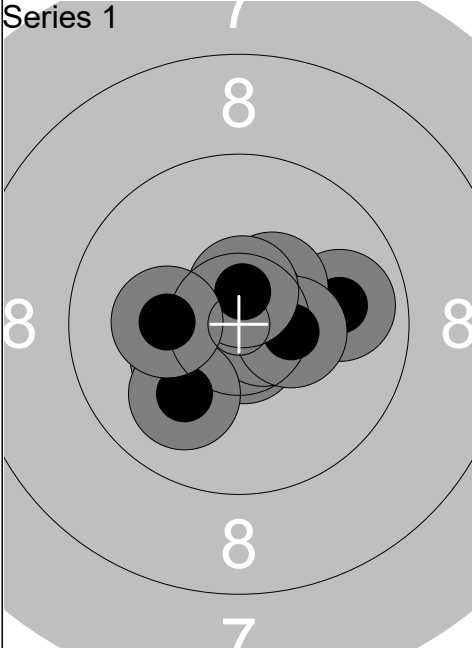
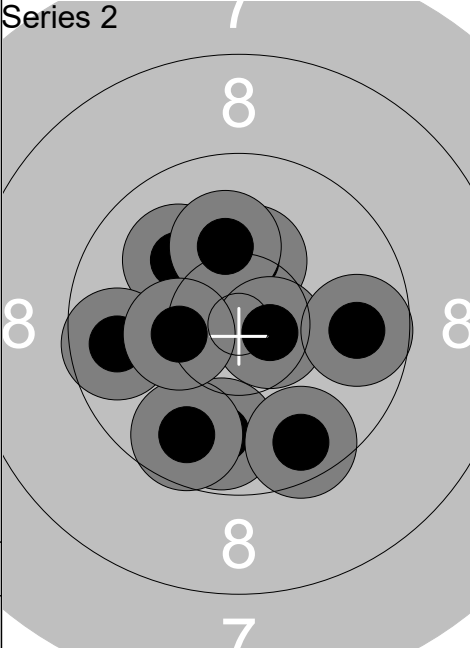
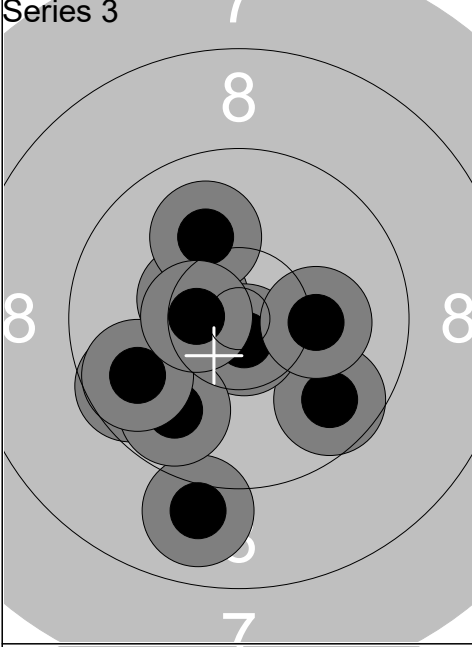
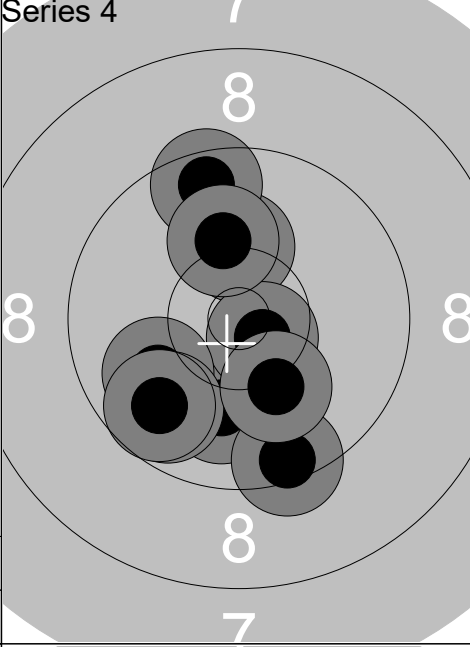
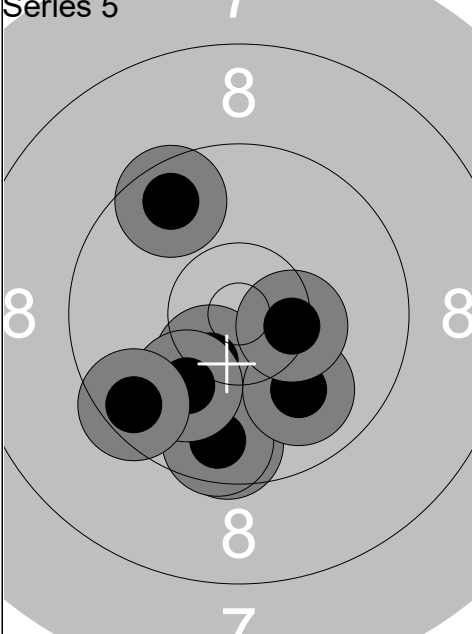
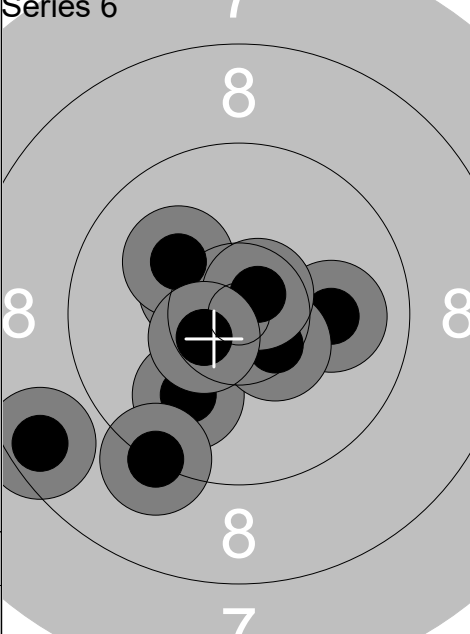
| Relay | Lane | Christian Reitz | | |
|--|-----------------|--|-----------------|-----------------------|
| 5 | 10 | GER | Mp | P |
| Qual Day 3 | | Denmark Open Air 2026 | | Denmark Open Air 2026 |
| 11.02.2026 | | | | |
| Series 1  | 1: 10.3 ↙ | Series 2  | 1: 9.8 ↓ | |
| | 2: 9.9 → | | 2: 9.6 ↓ | |
| | 3: 10.7x ↓ | | 3: 10.1 ↗ | |
| | 4: 10.5x ↗ | | 4: 10.3 ↑ | |
| | 5: 10.9x ↑ | | 5: 9.7 ← | |
| | 6: 10.7x → | | 6: 10.1 ↑ | |
| | 7: 10.1 ↓ | | 7: 10.6x → | |
| | 8: 10.4x → | | 8: 9.7 ↓ | |
| | 9: 10.6x ↑ | | 9: 9.8 → | |
| | 10: 10.2 ← | | 10: 10.3 ← | |
| | Series 99 (6x) | | Series 95 (1x) | |
| | 99 (6x) | | 194 (7x) | |
| Series 3  | 1: 10.5x ↙ | Series 4  | 1: 10.0 ↓ | |
| | 2: 9.0 ↓ | | 2: 10.2 ↑ | |
| | 3: 10.1 ↗ | | 3: 9.6 ↑ | |
| | 4: 9.7 ↘ | | 4: 9.4 ↓ | |
| | 5: 10.7x ↓ | | 5: 10.6x ↘ | |
| | 6: 9.7 ← | | 6: 10.2 ↑ | |
| | 7: 10.2 → | | 7: 10.0 ↙ | |
| | 8: 9.8 ↓ | | 8: 9.8 ↓ | |
| | 9: 9.8 ← | | 9: 9.8 ↙ | |
| | 10: 10.5x ↙ | | 10: 10.2 ↘ | |
| | Series 95 (3x) | | Series 96 (1x) | |
| | 289 (10x) | | 385 (11x) | |
| Series 5  | 1: 9.6 ↗ | Series 6  | 1: 10.7x ↗ | |
| | 2: 9.9 ↓ | | 2: 10.4x ↙ | |
| | 3: 10.3 ↓ | | 3: 10.0 ↓ | |
| | 4: 10.4x ↙ | | 4: 10.1 ↗ | |
| | 5: 9.6 ↓ | | 5: 10.0 → | |
| | 6: 9.7 ↓ | | 6: 10.5x ↘ | |
| | 7: 10.0 ↓ | | 7: 8.6 ← | |
| | 8: 10.4x → | | 8: 10.7x ↗ | |
| | 9: 10.1 ↓ | | 9: 10.5x ↙ | |
| | 10: 9.5 ← | | 10: 9.3 ↓ | |
| | Series 95 (2x) | | Series 97 (5x) | |
| | 480 (13x) | | 577 (18x) | |

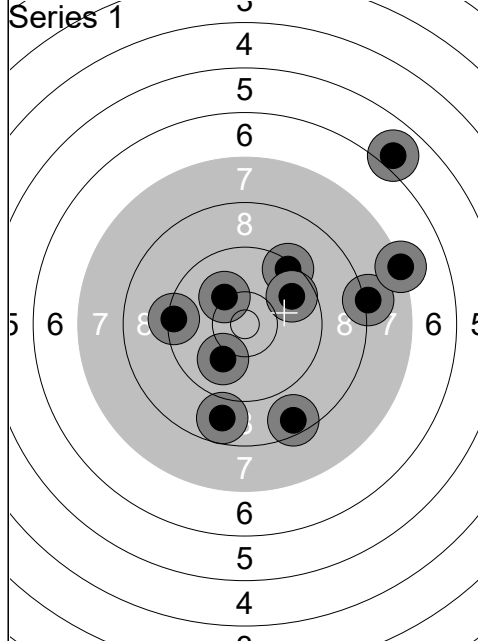

| |
|------------|
| 1: 8.1 → |
| 2: 9.4 ↗ |
| 3: 9.7 ↗ |
| 4: 10.0 ↓ |
| 5: 8.6 ↓ |
| 6: 5.9 ↗ |
| 7: 9.4 ← |
| 8: 8.8 ↓ |
| 9: 7.2 → |
| 10: 10.2 ↖ |

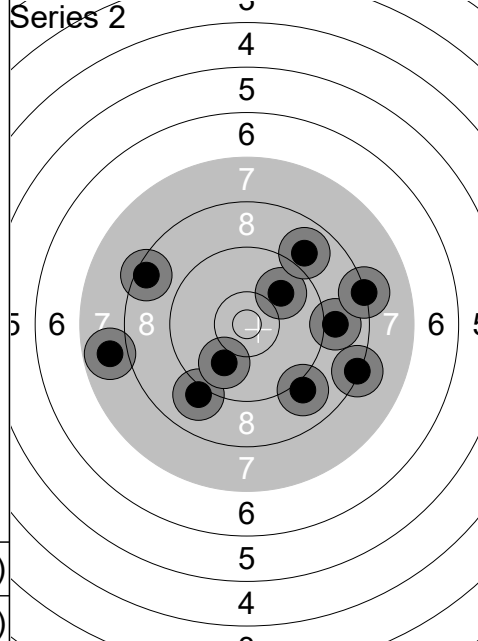

| |
|-----------|
| 1: 9.9 ↗ |
| 2: 9.0 → |
| 3: 7.8 ← |
| 4: 8.3 → |
| 5: 9.0 ↓ |
| 6: 8.9 ↗ |
| 7: 8.5 ← |
| 8: 9.1 ↓ |
| 9: 10.0 ↓ |
| 10: 8.2 → |

| |
|-----------------|
| Series 83 (0x) |
| 83 (0x) |

| |
|-----------------|
| Series 85 (0x) |
| 168 (0x) |

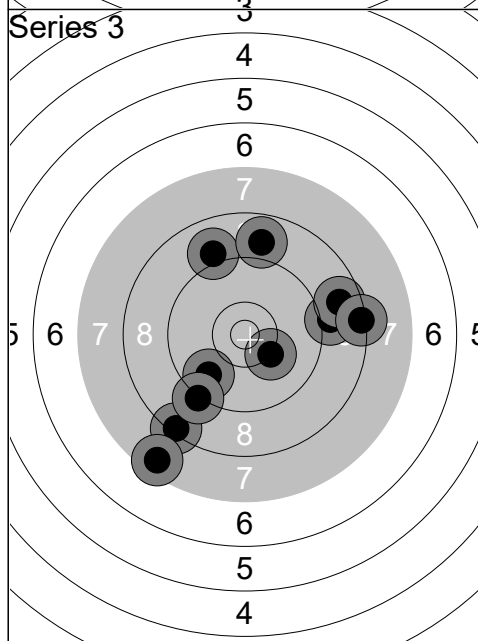

| |
|-----------|
| 1: 9.0 → |
| 2: 9.7 ↓ |
| 3: 8.4 ↓ |
| 4: 9.0 ↗ |
| 5: 10.2 ↓ |
| 6: 8.7 → |
| 7: 8.3 → |
| 8: 7.5 ↓ |
| 9: 9.2 ↓ |
| 10: 8.9 ↑ |

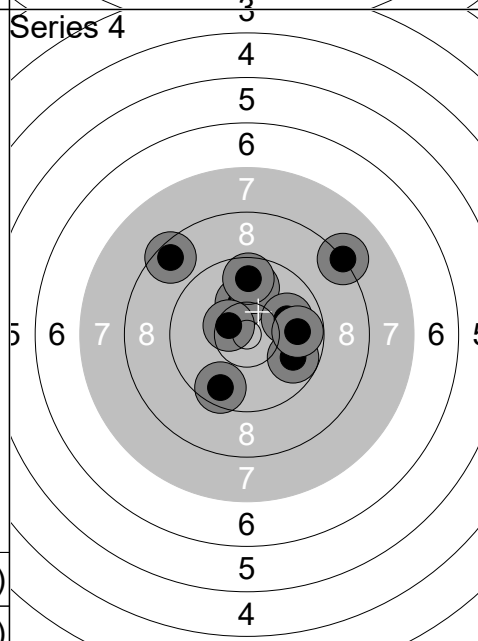

| |
|------------|
| 1: 10.2 ↑ |
| 2: 9.9 ↑ |
| 3: 9.6 ↓ |
| 4: 8.5 ↖ |
| 5: 9.8 → |
| 6: 8.2 ↗ |
| 7: 9.7 ↑ |
| 8: 10.5x ↖ |
| 9: 10.0 → |
| 10: 9.8 → |

| |
|-----------------|
| Series 85 (0x) |
| 253 (0x) |

| |
|-----------------|
| Series 91 (1x) |
| 344 (1x) |

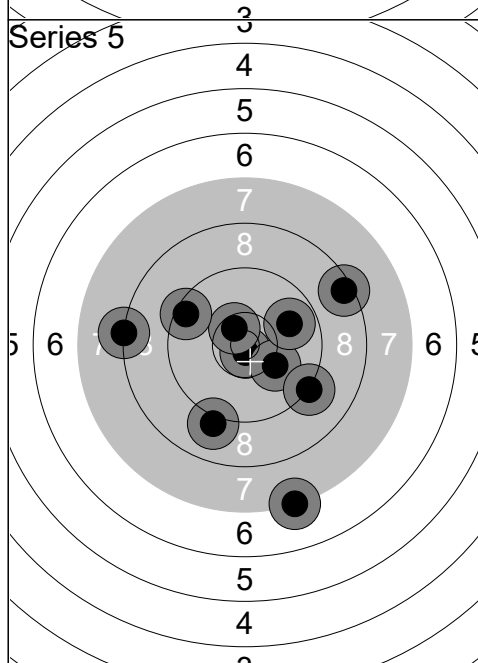

| |
|------------|
| 1: 8.4 → |
| 2: 10.8x ↓ |
| 3: 9.1 ↓ |
| 4: 10.1 ↓ |
| 5: 7.2 ↓ |
| 6: 10.5x ↗ |
| 7: 9.5 ← |
| 8: 9.8 → |
| 9: 9.2 ↓ |
| 10: 8.2 ← |

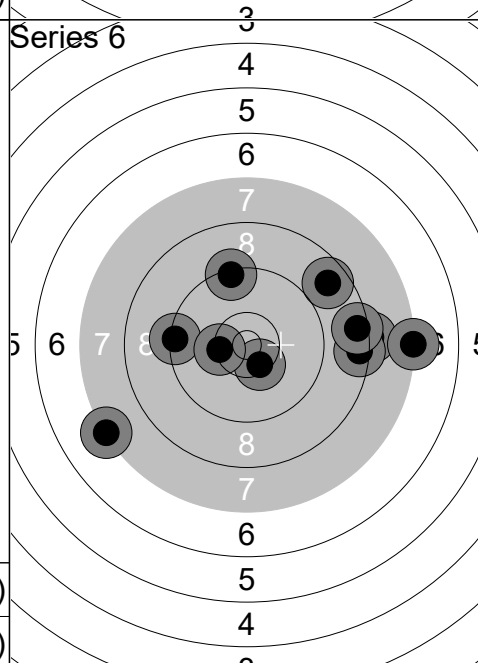

| |
|------------|
| 1: 8.2 → |
| 2: 10.4x ↓ |
| 3: 8.4 → |
| 4: 7.3 ↖ |
| 5: 9.3 ← |
| 6: 8.5 → |
| 7: 9.4 ↑ |
| 8: 10.3 ← |
| 9: 7.2 → |
| 10: 8.7 ↗ |

| |
|-----------------|
| Series 89 (2x) |
| 433 (3x) |

| |
|-----------------|
| Series 84 (1x) |
| 517 (4x) |

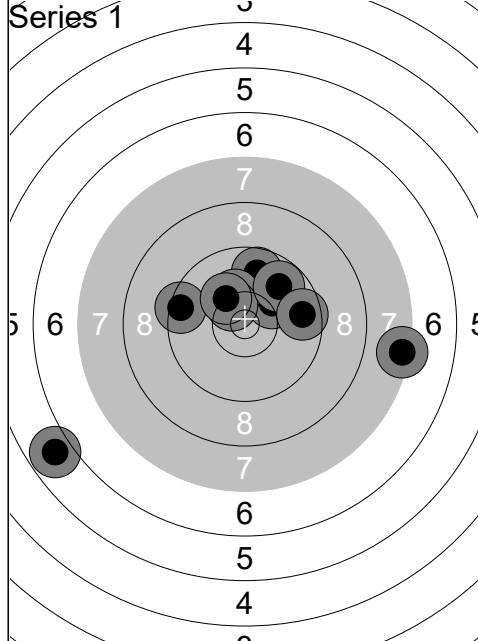

| |
|------------------------|
| 1: 7.4 → |
| 2: 10.2 ↗ |
| 3: 9.5 ← |
| 4: 9.8 ↑ |
| 5: 10.3 ↑ |
| 6: 10.4x ↖ |
| 7: 9.8 ↗ |
| 8: 9.7 → |
| 9: 10.2 ↖ |
| 10: 5.9 ← |
| Series 88 (1x) |
| 88 (1x) |

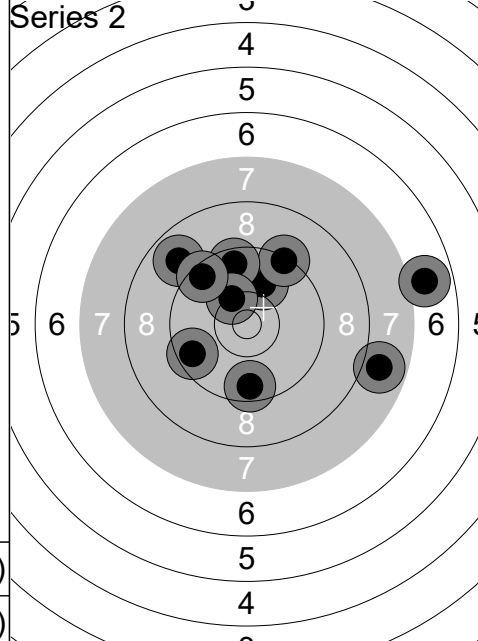

| |
|------------------------|
| 1: 10.0 ↗ |
| 2: 7.9 → |
| 3: 8.9 ↖ |
| 4: 9.3 ↗ |
| 5: 9.6 ↑ |
| 6: 9.6 ← |
| 7: 6.9 → |
| 8: 10.3 ↖ |
| 9: 9.5 ↖ |
| 10: 9.6 ↓ |
| Series 86 (0x) |
| 174 (1x) |

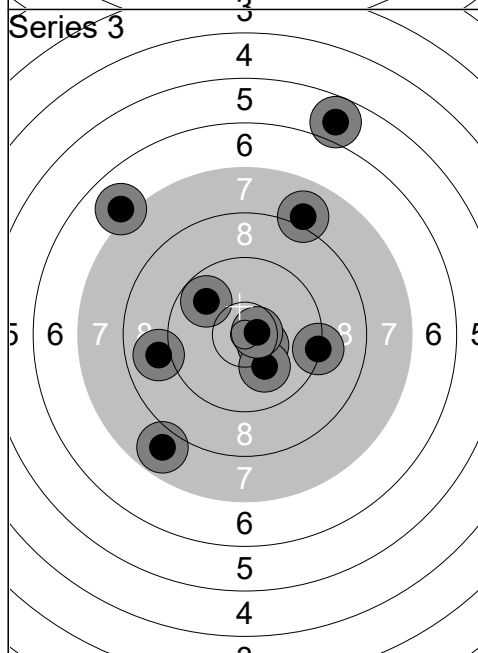

| |
|------------------------|
| 1: 9.8 ↖ |
| 2: 8.0 ↗ |
| 3: 9.3 → |
| 4: 5.8 ↑ |
| 5: 10.5x ↗ |
| 6: 7.8 ↘ |
| 7: 7.0 ↗ |
| 8: 9.0 ← |
| 9: 10.1 ↘ |
| 10: 10.7x → |
| Series 84 (2x) |
| 258 (3x) |

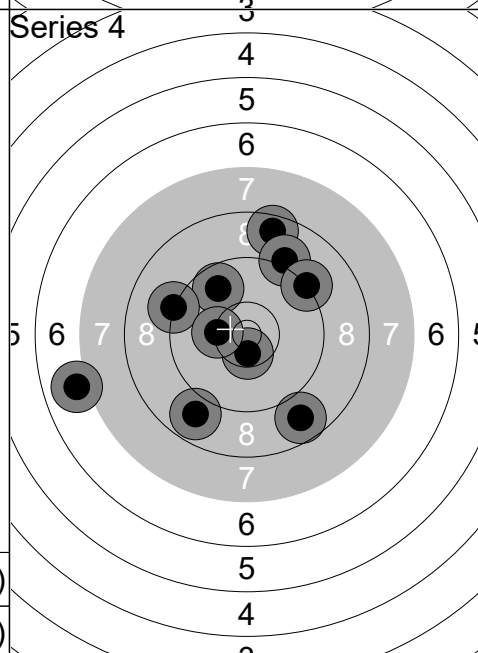

| |
|------------------------|
| 1: 8.6 ↑ |
| 2: 9.1 ↗ |
| 3: 9.7 ↖ |
| 4: 9.2 ↗ |
| 5: 9.2 ← |
| 6: 10.5x ↓ |
| 7: 7.0 ← |
| 8: 8.8 ↘ |
| 9: 10.3 ← |
| 10: 8.7 ↘ |
| Series 87 (1x) |
| 345 (4x) |

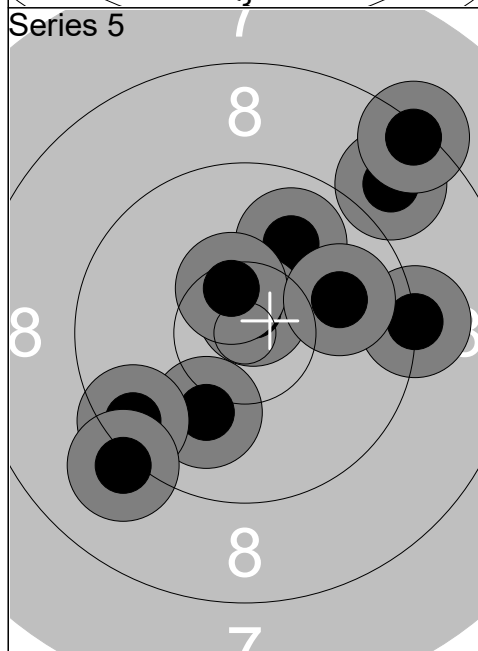

| |
|------------------------|
| 1: 10.1 ↓ |
| 2: 9.9 ↗ |
| 3: 9.5 ← |
| 4: 9.1 ↘ |
| 5: 8.8 ↗ |
| 6: 9.2 → |
| 7: 10.7x ↑ |
| 8: 10.5x ↑ |
| 9: 8.3 ↗ |
| 10: 9.9 → |
| Series 91 (2x) |
| 436 (6x) |

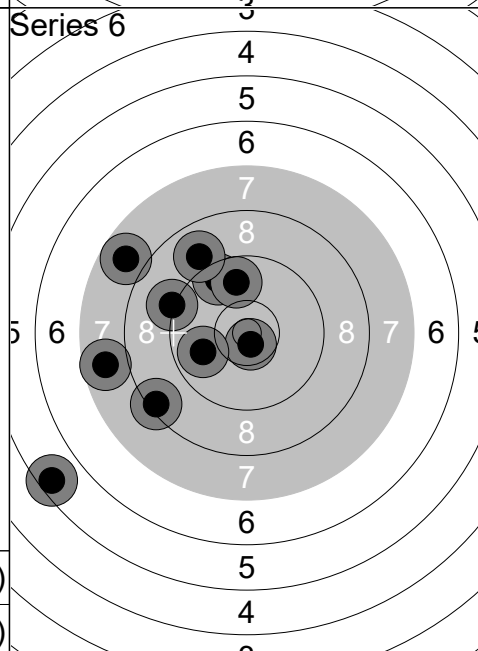

| |
|------------------------|
| 1: 9.6 ↖ |
| 2: 10.7x ↓ |
| 3: 9.8 ↑ |
| 4: 9.2 ← |
| 5: 7.8 ↖ |
| 6: 9.9 ← |
| 7: 8.4 ↘ |
| 8: 7.7 ← |
| 9: 8.9 ↖ |
| 10: 5.5 ← |
| Series 81 (1x) |
| 517 (7x) |

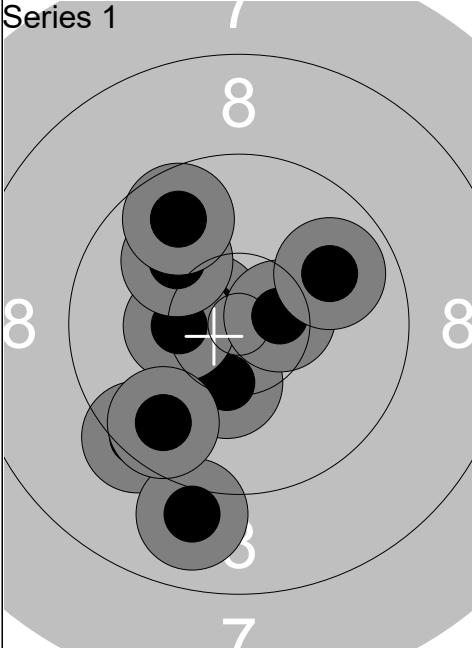
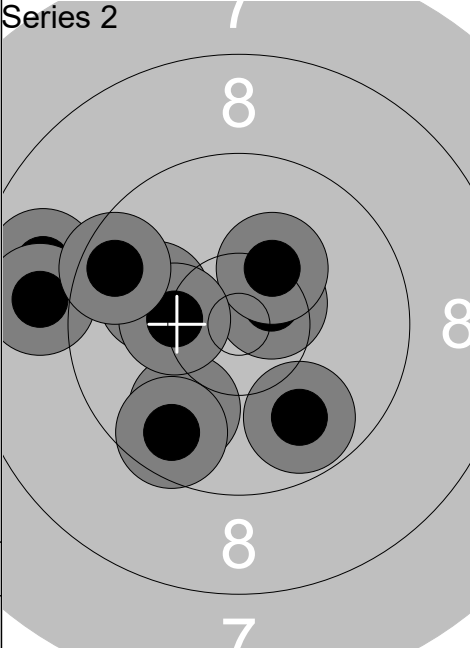
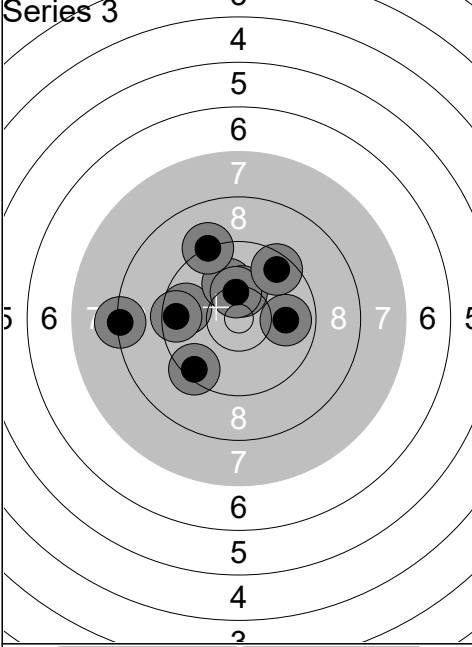
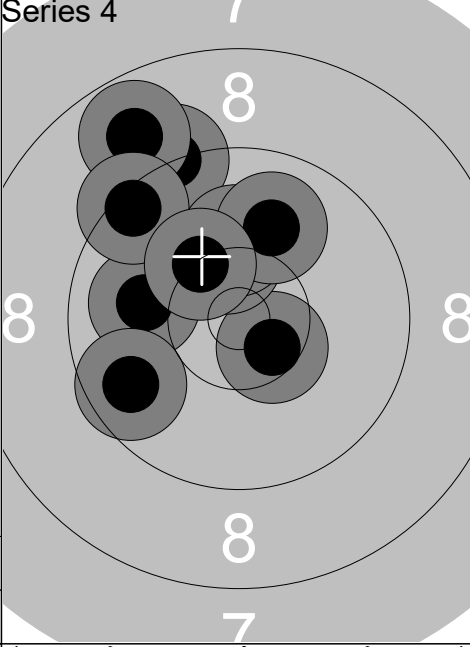
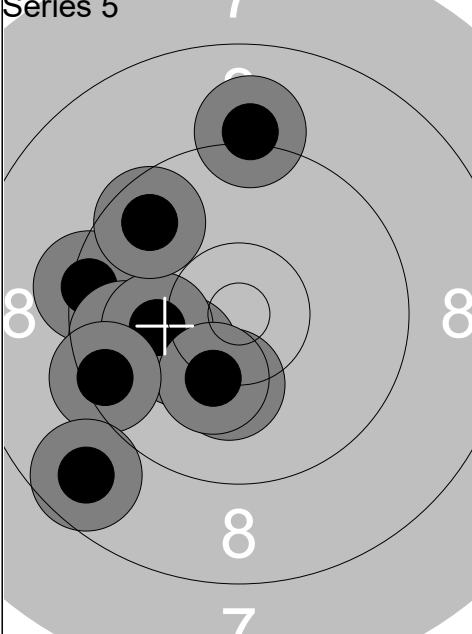
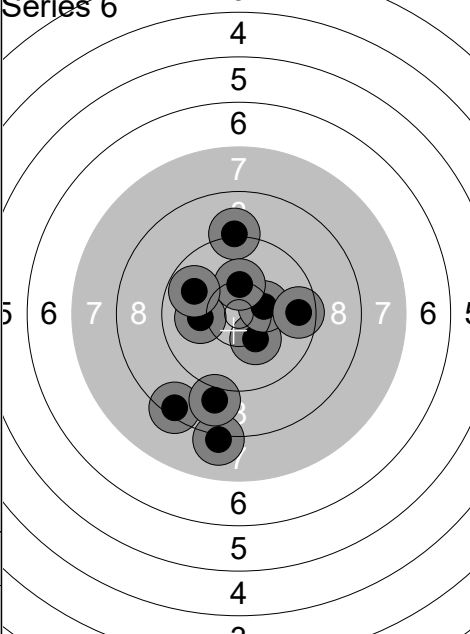
| Relay | Lane | Name | | | | | |
|------------|--|--|------------------------------|-----------------------|--|--|------------------------------|
| 5 | 13 | Marcus Errebo | | | | | |
| Qual Day 3 | | DEN | Mp | P | | | |
| 11.02.2026 | | Denmark Open Air 2026 | | Denmark Open Air 2026 | | | |
| Series 1 |  | 1: 10.6x ↙ 2: 10.3 ↓ 3: 9.4 ↘ 4: 9.0 ↓ 5: 10.3 ← 6: 9.7 ↘ 7: 10.5x → 8: 10.1 ↖ 9: 9.7 ↗ 10: 9.9 ↗ | Series 95 (2x) 95 (2x) | Series 2 |  | 1: 9.9 ↘ 2: 10.1 ← 3: 9.8 ↘ 4: 9.7 ↘ 5: 10.6x → 6: 10.3 ↗ 7: 10.3 ← 8: 8.9 ← 9: 8.9 ← 10: 9.6 ← | Series 92 (1x) 187 (3x) |
| Series 3 |  | 1: 8.3 ← 2: 9.4 ↘ 3: 9.8 ← 4: 10.1 ↗ 5: 9.5 ← 6: 10.3 ↑ 7: 9.2 ↗ 8: 10.4 ↑ 9: 9.9 → 10: 9.6 ↗ | Series 92 (0x) 279 (3x) | Series 4 |  | 1: 9.2 ↗ 2: 10.0 ← 3: 10.5x ↘ 4: 10.3 ↑ 5: 8.8 ↗ 6: 9.4 ↗ 7: 10.2 ↑ 8: 9.7 ↙ 9: 10.0 ↑ 10: 10.3 ↖ | Series 95 (1x) 374 (4x) |
| Series 5 |  | 1: 9.4 ← 2: 10.2 ↓ 3: 10.3 ↙ 4: 9.8 ← 5: 10.1 ← 6: 10.3 ↓ 7: 9.5 ← 8: 8.7 ↘ 9: 9.1 ↑ 10: 9.7 ↖ | Series 93 (0x) 467 (4x) | Series 6 |  | 1: 9.2 ↑ 2: 10.1 ← 3: 10.3 ↘ 4: 10.4x → 5: 8.1 ↓ 6: 10.3 ↑ 7: 8.4 ↘ 8: 9.6 → 9: 9.8 ↙ 10: 8.9 ↓ | Series 91 (1x) 558 (5x) |

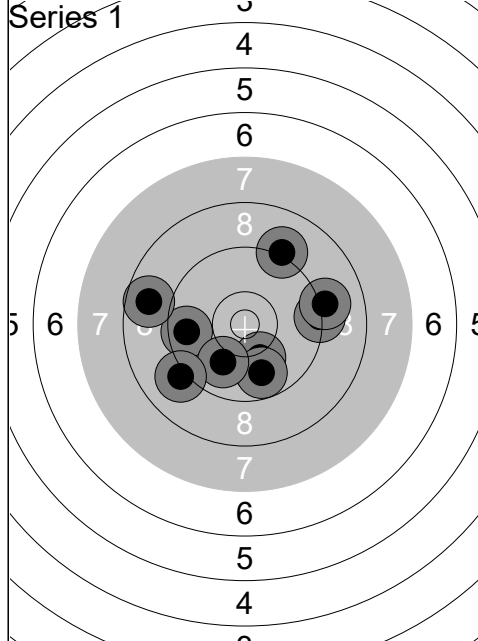

| | | |
|---------------|-----------------|---|
| 1: | 9.6 | ← |
| 2: | 10.0 | ↓ |
| 3: | 9.2 | ↗ |
| 4: | 9.3 | → |
| 5: | 10.1 | ↓ |
| 6: | 9.8 | ↓ |
| 7: | 8.8 | ← |
| 8: | 10.0 | ↓ |
| 9: | 9.1 | → |
| 10: | 9.1 | ← |
| Series | 92 (0x) | |
| | 92 (0x) | |

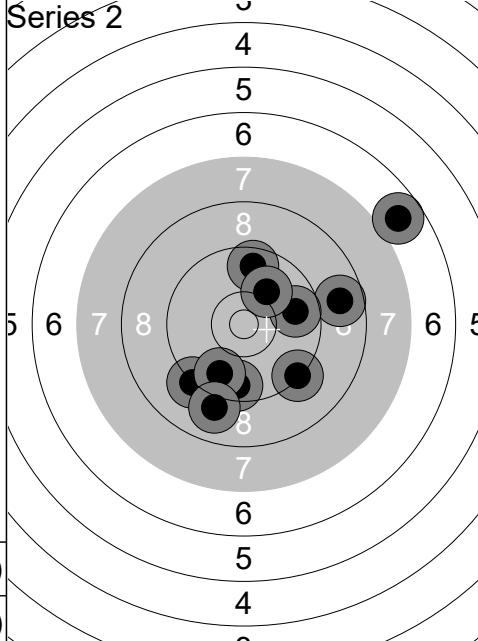

| | | |
|---------------|------------------|---|
| 1: | 9.3 | ↘ |
| 2: | 8.8 | → |
| 3: | 6.8 | ↗ |
| 4: | 9.6 | ↓ |
| 5: | 9.6 | ↑ |
| 6: | 9.2 | ↙ |
| 7: | 9.8 | → |
| 8: | 9.7 | ↓ |
| 9: | 9.0 | ↓ |
| 10: | 10.1 | ↗ |
| Series | 87 (0x) | |
| | 179 (0x) | |

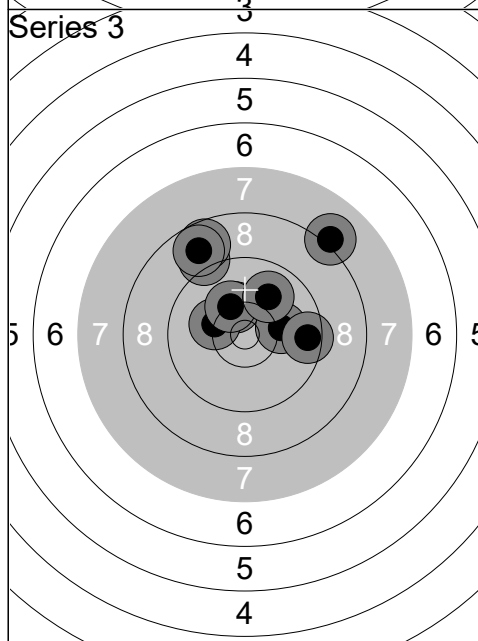

| | | |
|---------------|------------------|---|
| 1: | 10.3 | ↗ |
| 2: | 10.2 | ← |
| 3: | 10.1 | → |
| 4: | 9.0 | ↗ |
| 5: | 8.1 | ↗ |
| 6: | 10.3 | ↗ |
| 7: | 8.7 | ↗ |
| 8: | 10.0 | ↗ |
| 9: | 9.5 | → |
| 10: | 8.8 | ↗ |
| Series | 92 (0x) | |
| | 271 (0x) | |

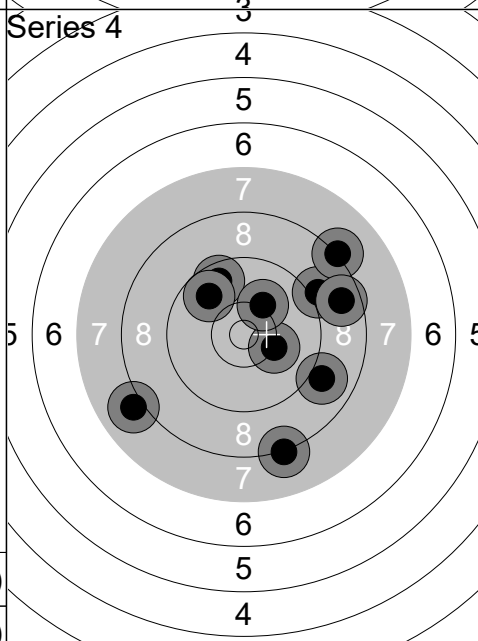

| | | |
|---------------|------------------|---|
| 1: | 8.0 | ← |
| 2: | 9.6 | ↗ |
| 3: | 9.1 | ↗ |
| 4: | 8.2 | ↓ |
| 5: | 9.0 | ↘ |
| 6: | 9.8 | ↗ |
| 7: | 8.2 | ↗ |
| 8: | 8.6 | → |
| 9: | 10.2 | ↘ |
| 10: | 10.2 | ↗ |
| Series | 88 (0x) | |
| | 359 (0x) | |

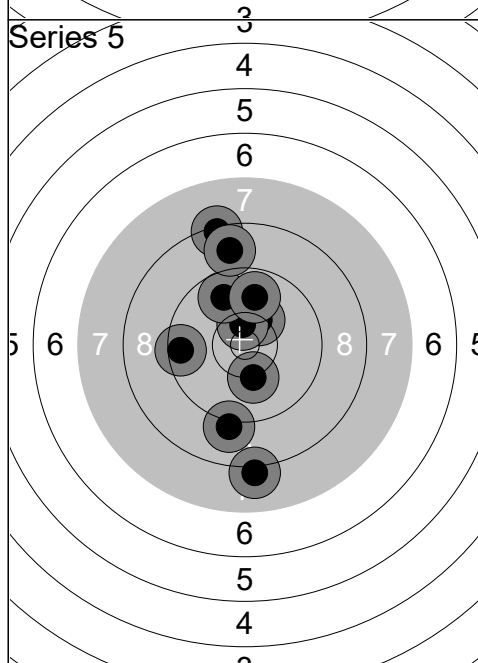

| | | |
|---------------|------------------|---|
| 1: | 10.3 | ↗ |
| 2: | 10.5x | ↑ |
| 3: | 9.1 | ↓ |
| 4: | 9.8 | ↗ |
| 5: | 8.3 | ↗ |
| 6: | 9.5 | ← |
| 7: | 10.2 | ↓ |
| 8: | 8.8 | ↗ |
| 9: | 9.9 | ↗ |
| 10: | 8.1 | ↓ |
| Series | 90 (1x) | |
| | 449 (1x) | |

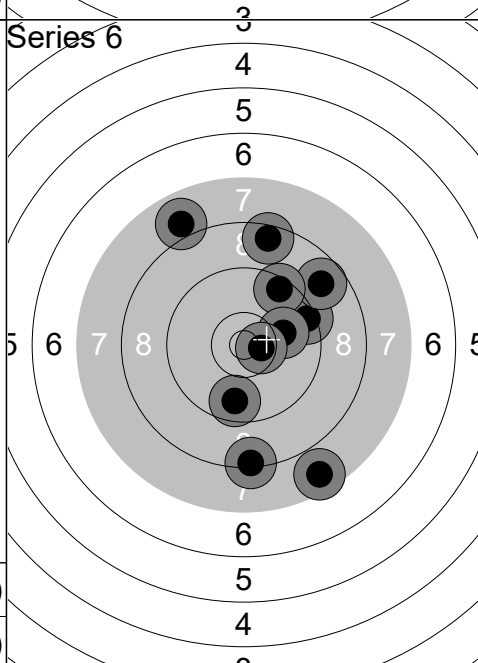

| | | |
|---------------|------------------|---|
| 1: | 8.5 | ↑ |
| 2: | 9.4 | → |
| 3: | 8.8 | ↗ |
| 4: | 9.5 | ↗ |
| 5: | 10.0 | → |
| 6: | 7.9 | ↗ |
| 7: | 9.7 | ↓ |
| 8: | 7.6 | ↓ |
| 9: | 8.3 | ↓ |
| 10: | 10.6x | → |
| Series | 85 (1x) | |
| | 534 (2x) | |

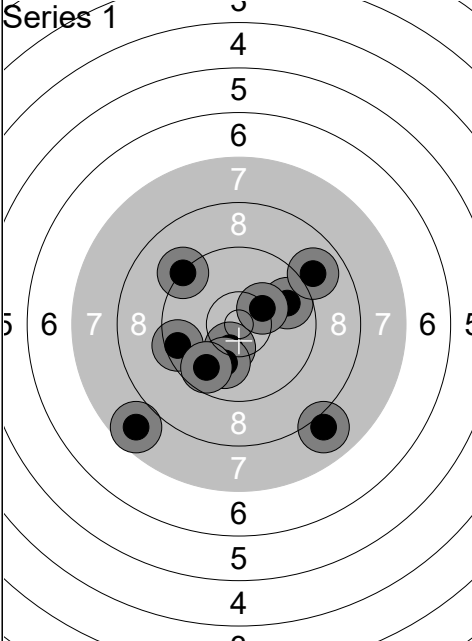
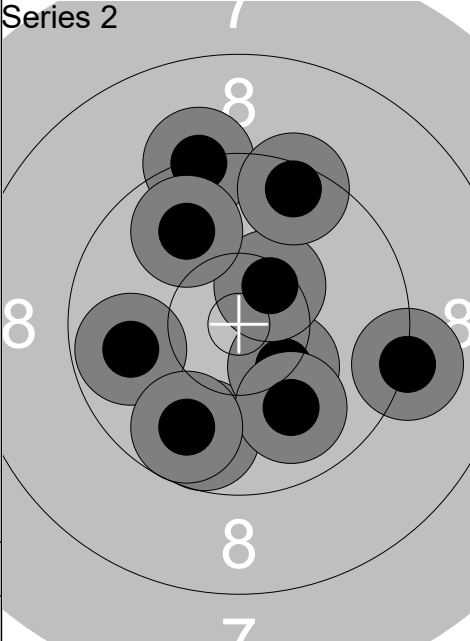
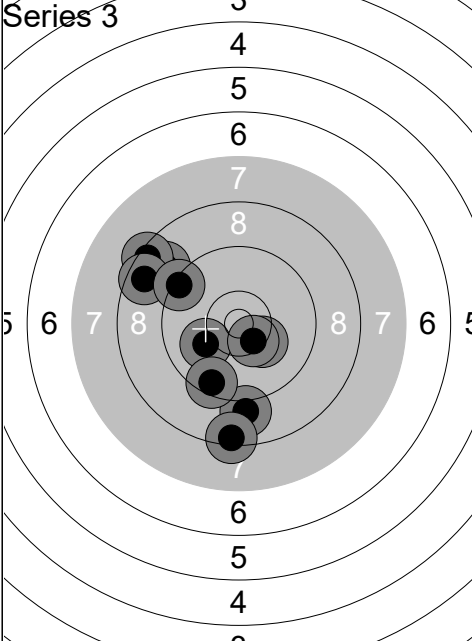
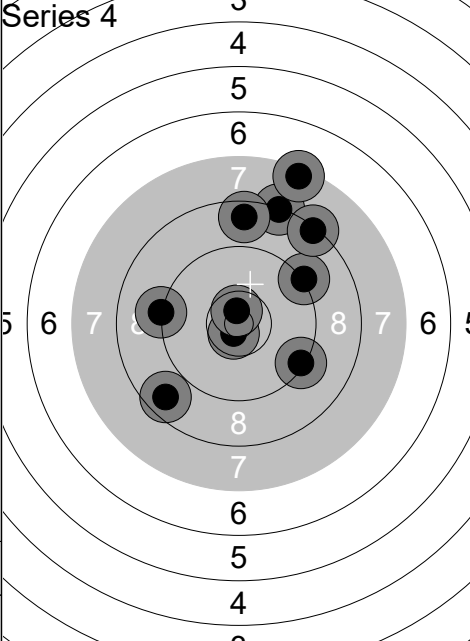
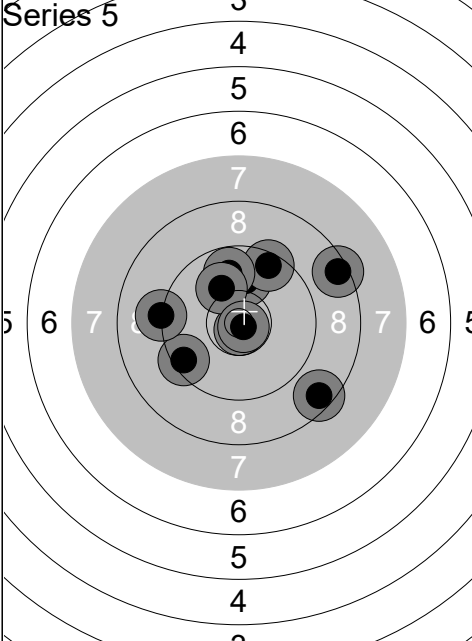
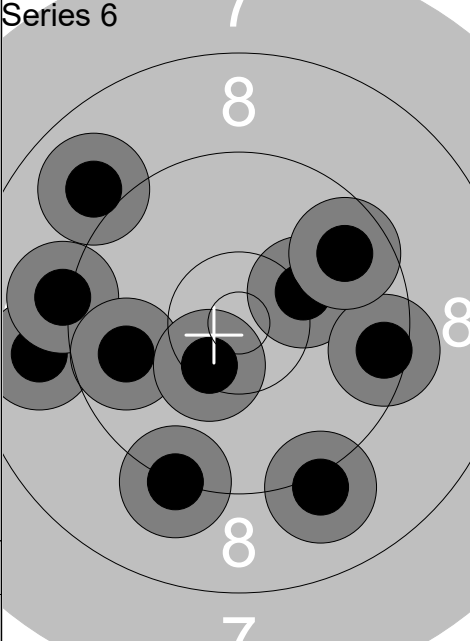
| Relay | Lane | Viggo Olden | | |
|--|-----------------------|--|-------------|---|
| 5 | 15 | NOR | Mp | P |
| 11.02.2026 | Denmark Open Air 2026 | Denmark Open Air 2026 | | |
|  | 1: 9.8 → |  | 1: 9.8 ↓ | |
| | 2: 9.5 ← | | 2: 9.3 ↑ | |
| | 3: 10.4x ↓ | | 3: 10.3 ↘ | |
| | 4: 8.0 ↘ | | 4: 9.8 ← | |
| | 5: 10.3 → | | 5: 10.4x ↗ | |
| | 6: 9.0 → | | 6: 9.9 ↗ | |
| | 7: 9.3 ↖ | | 7: 10.0 ↘ | |
| | 8: 10.0 ↓ | | 8: 9.5 ↑ | |
| | 9: 9.7 ↓ | | 9: 9.8 ↓ | |
| | 10: 7.7 ↘ | | 10: 9.2 → | |
| Series 90 (1x) | 90 (1x) | Series 93 (1x) | 93 (1x) | |
| | 272 (3x) | | 183 (2x) | |
|  | 1: 8.9 ↖ |  | 1: 9.2 ← | |
| | 2: 10.1 ← | | 2: 8.3 ↑ | |
| | 3: 9.0 ↓ | | 3: 10.7x ↓ | |
| | 4: 8.4 ↖ | | 4: 8.6 ↘ | |
| | 5: 10.3 ↘ | | 5: 9.2 → | |
| | 6: 8.4 ↓ | | 6: 9.3 ↘ | |
| | 7: 10.4x ↓ | | 7: 8.3 ↗ | |
| | 8: 9.5 ↓ | | 8: 8.6 ↑ | |
| | 9: 8.6 ← | | 9: 7.4 ↑ | |
| | 10: 9.4 ↖ | | 10: 10.7x ↑ | |
| Series 89 (1x) | 89 (1x) | Series 86 (2x) | 86 (2x) | |
| | 272 (3x) | | 358 (5x) | |
|  | 1: 9.5 ← |  | 1: 9.0 ↖ | |
| | 2: 10.8x ↓ | | 2: 8.9 ← | |
| | 3: 8.5 ↘ | | 3: 9.2 ← | |
| | 4: 9.2 ← | | 4: 10.2 → | |
| | 5: 10.0 ↑ | | 5: 9.5 → | |
| | 6: 9.5 ↗ | | 6: 9.2 ↓ | |
| | 7: 8.5 → | | 7: 9.7 → | |
| | 8: 9.8 ↑ | | 8: 9.8 ← | |
| | 9: 10.1 ↗ | | 9: 9.1 ↓ | |
| | 10: 10.8x ↘ | | 10: 10.4x ↓ | |
| Series 92 (2x) | 92 (2x) | Series 91 (1x) | 91 (1x) | |
| | 450 (7x) | | 541 (8x) | |

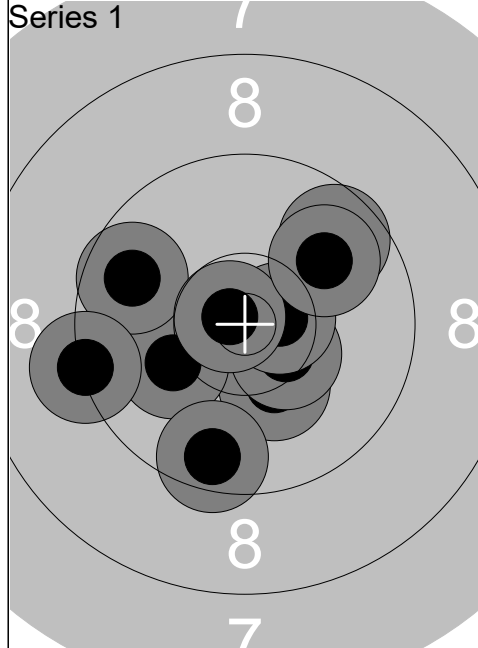

| | | |
|---------------|-----------------|---|
| 1: | 10.3 | ↘ |
| 2: | 10.1 | ↙ |
| 3: | 9.6 | ↓ |
| 4: | 10.4x | ↘ |
| 5: | 9.7 | ↙ |
| 6: | 10.6x | → |
| 7: | 10.8x | ↙ |
| 8: | 9.3 | ↙ |
| 9: | 9.7 | ↗ |
| 10: | 9.9 | ↗ |
| Series | 95 (3x) | |
| | 95 (3x) | |

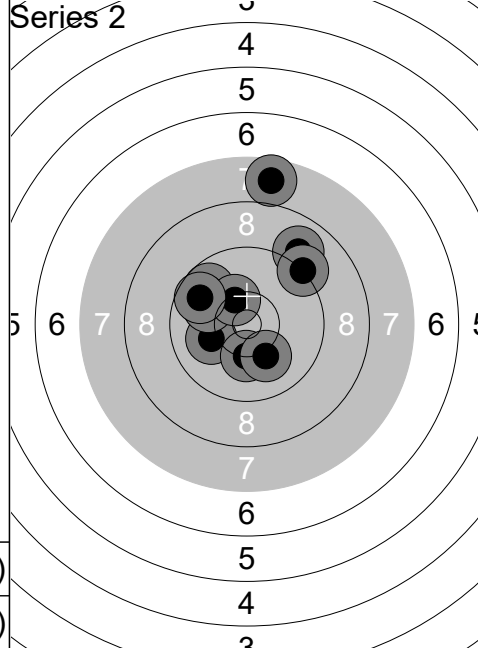

| | | |
|---------------|------------------|---|
| 1: | 9.8 | ↖ |
| 2: | 10.1 | ↙ |
| 3: | 7.7 | ↑ |
| 4: | 10.2 | ↓ |
| 5: | 10.0 | ↙ |
| 6: | 10.4 | ↖ |
| 7: | 9.0 | ↗ |
| 8: | 9.2 | ↗ |
| 9: | 9.7 | ↙ |
| 10: | 10.1 | ↘ |
| Series | 93 (0x) | |
| | 188 (3x) | |

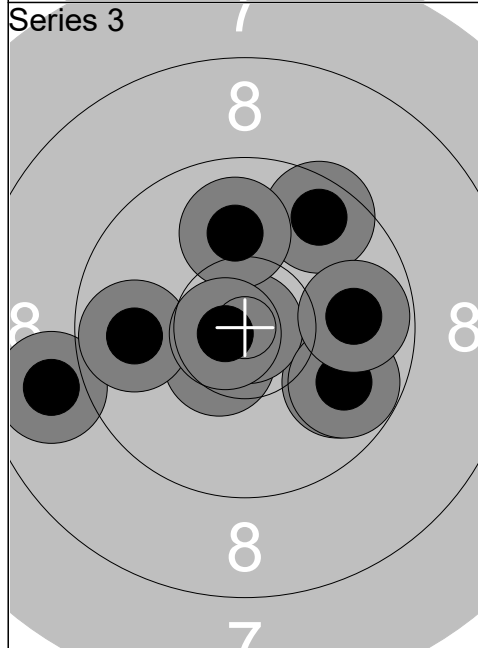

| | | |
|---------------|------------------|---|
| 1: | 9.9 | ↘ |
| 2: | 10.5x | ↘ |
| 3: | 10.9x | → |
| 4: | 9.8 | ↘ |
| 5: | 9.6 | ↗ |
| 6: | 8.9 | ↙ |
| 7: | 9.8 | → |
| 8: | 9.8 | ↙ |
| 9: | 10.0 | ↑ |
| 10: | 10.7x | ↙ |
| Series | 93 (3x) | |
| | 281 (6x) | |

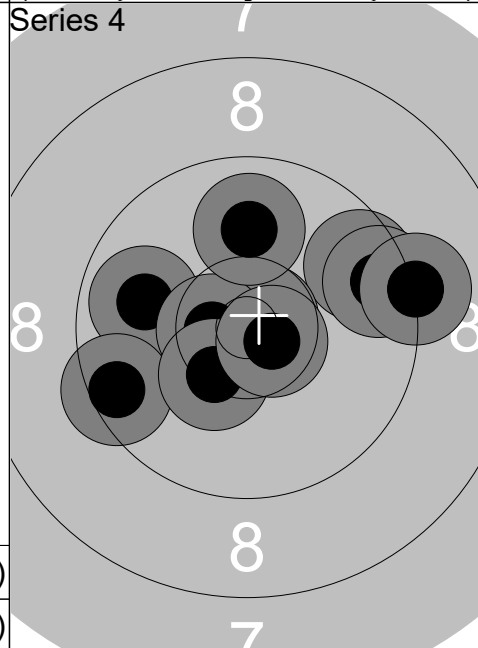

| | | |
|---------------|------------------|---|
| 1: | 9.7 | ↗ |
| 2: | 9.9 | ↙ |
| 3: | 10.8x | ↗ |
| 4: | 9.5 | ↙ |
| 5: | 10.6x | ↙ |
| 6: | 10.0 | ↑ |
| 7: | 10.4x | ↘ |
| 8: | 10.7x | ↘ |
| 9: | 9.5 | ↗ |
| 10: | 9.2 | → |
| Series | 95 (4x) | |
| | 376 (10x) | |

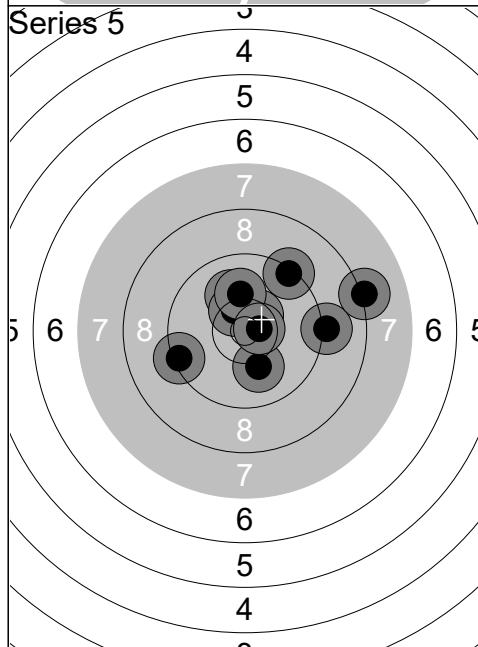

| | | |
|---------------|------------------|---|
| 1: | 10.1 | ↖ |
| 2: | 10.5x | ↗ |
| 3: | 10.1 | ↓ |
| 4: | 9.1 | → |
| 5: | 8.2 | → |
| 6: | 9.3 | ↗ |
| 7: | 10.4x | ↖ |
| 8: | 10.1 | ↑ |
| 9: | 9.4 | ↙ |
| 10: | 10.6x | → |
| Series | 95 (3x) | |
| | 471 (13x) | |

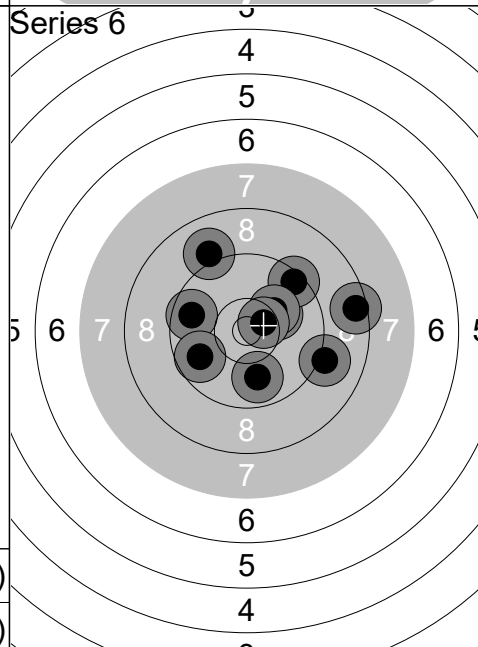

| | | |
|---------------|------------------|---|
| 1: | 10.2 | ↗ |
| 2: | 9.4 | ↗ |
| 3: | 9.0 | ↖ |
| 4: | 9.7 | ↙ |
| 5: | 8.5 | → |
| 6: | 10.2 | ↗ |
| 7: | 9.1 | → |
| 8: | 9.9 | ↓ |
| 9: | 9.8 | ↙ |
| 10: | 10.5x | ↗ |
| Series | 92 (1x) | |
| | 563 (14x) | |

| Relay | Lane | Felipe Wu | | |
|------------|------|-----------------------|----------|-----------------------|
| 5 | 17 | BRA | Mp | P |
| Qual Day 3 | | Denmark Open Air 2026 | | Denmark Open Air 2026 |
| 11.02.2026 | | | | |
| Series 1 | | 1: 10.1 ↙ | Series 2 | 1: 10.7x → |
| | | 2: 10.2 ↓ | | 2: 10.5x ↑ |
| | | 3: 10.2 ↗ | | 3: 9.6 → |
| | | 4: 9.6 ↓ | | 4: 10.0 ↖ |
| | | 5: 10.3 ↓ | | 5: 10.5x → |
| | | 6: 10.1 ↑ | | 6: 10.5x ↗ |
| | | 7: 9.0 ↑ | | 7: 9.7 ← |
| | | 8: 9.9 ↙ | | 8: 10.3 ← |
| | | 9: 9.5 ↗ | | 9: 10.4x ↓ |
| | | 10: 10.8x ↘ | | 10: 10.3 ↓ |
| | | Series 96 (1x) | | Series 98 (5x) |
| | | 96 (1x) | | 194 (6x) |
| Series 3 | | 1: 10.0 → | Series 4 | 1: 10.0 ↖ |
| | | 2: 9.9 ↑ | | 2: 10.3 → |
| | | 3: 10.1 ↑ | | 3: 9.8 ↙ |
| | | 4: 10.5x ↓ | | 4: 10.3 ↓ |
| | | 5: 10.3 ↖ | | 5: 9.7 ↓ |
| | | 6: 10.2 ↑ | | 6: 9.9 ↑ |
| | | 7: 9.7 ↗ | | 7: 10.5x ← |
| | | 8: 9.9 ↓ | | 8: 9.8 ↗ |
| | | 9: 10.5x → | | 9: 9.5 ↑ |
| | | 10: 9.2 ← | | 10: 10.4x ↙ |
| | | Series 96 (2x) | | Series 95 (2x) |
| | | 290 (8x) | | 385 (10x) |
| Series 5 | | 1: 9.4 ↑ | Series 6 | 1: 10.1 → |
| | | 2: 10.2 ← | | 2: 10.3 ↗ |
| | | 3: 10.7x → | | 3: 10.4x ↘ |
| | | 4: 10.6x ↓ | | 4: 10.7x ↗ |
| | | 5: 10.2 ↓ | | 5: 10.1 ↖ |
| | | 6: 9.6 ↘ | | 6: 10.4x ↑ |
| | | 7: 10.7x ↓ | | 7: 10.0 ← |
| | | 8: 9.9 ↓ | | 8: 10.1 ↙ |
| | | 9: 9.2 ↑ | | 9: 9.0 ↑ |
| | | 10: 10.6x ↘ | | 10: 9.7 ↖ |
| | | Series 96 (4x) | | Series 98 (3x) |
| | | 481 (14x) | | 579 (17x) |

| Relay | Lane | Jeronimo Jimenez | | |
|---------------------|------------------------|---------------------|------------------------|---|
| 5 | 18 | COL | Mp | P |
| 11.02.2026 | Denmark Open Air 2026 | | Denmark Open Air 2026 | |
| Series 1 | 1: 9.1 ↗ | Series 2 | 1: 8.5 ↓ | |
| | 2: 8.7 ↙ | | 2: 10.1 ← | |
| | 3: 6.7 ↓ | | 3: 9.5 ↓ | |
| | 4: 10.0 → | | 4: 9.2 ↙ | |
| | 5: 6.5 ↓ | | 5: 5.6 ↓ | |
| | 6: 9.4 ← | | 6: 7.3 ↓ | |
| | 7: 9.8 ↓ | | 7: 6.9 ↙ | |
| | 8: 9.7 ↘ | | 8: 9.5 ↘ | |
| | 9: 9.0 ↓ | | 9: 9.4 ↓ | |
| | 10: 10.8x ↑ | | 10: 9.0 ↙ | |
| | Series 85 (1x) | | Series 81 (0x) | |
| | 85 (1x) | | 166 (1x) | |
| Series 3 | 1: 7.3 ↓ | Series 4 | 1: 9.7 → | |
| | 2: 9.5 ↘ | | 2: 8.4 ↑ | |
| | 3: 9.0 ↑ | | 3: 6.2 ↓ | |
| | 4: 8.0 ↗ | | 4: 10.0 ↓ | |
| | 5: 10.6x ↙ | | 5: 9.4 ↓ | |
| | 6: 9.6 ↓ | | 6: 10.4x ↙ | |
| | 7: 10.1 ↙ | | 7: 9.5 → | |
| | 8: 9.2 ↓ | | 8: 9.8 ↓ | |
| | 9: 8.9 ↙ | | 9: 8.1 ← | |
| | 10: 7.6 ↘ | | 10: 10.6x ↗ | |
| | Series 86 (1x) | | Series 88 (2x) | |
| | 252 (2x) | | 340 (4x) | |
| Series 5 | 1: 9.5 ↓ | Series 6 | 1: 10.2 ↗ | |
| | 2: 8.6 → | | 2: 8.6 ↑ | |
| | 3: 9.3 ↘ | | 3: 10.8x ↘ | |
| | 4: 9.8 → | | 4: 9.2 ↓ | |
| | 5: 9.5 → | | 5: 10.5x ↙ | |
| | 6: 9.5 ← | | 6: 9.0 ↗ | |
| | 7: 8.4 ↓ | | 7: 9.9 ↘ | |
| | 8: 9.4 → | | 8: 7.5 ↗ | |
| | 9: 9.0 ↓ | | 9: 9.5 ↓ | |
| | 10: 9.0 ↘ | | 10: 9.8 ↘ | |
| | Series 88 (0x) | | Series 90 (2x) | |
| | 428 (4x) | | 518 (6x) | |

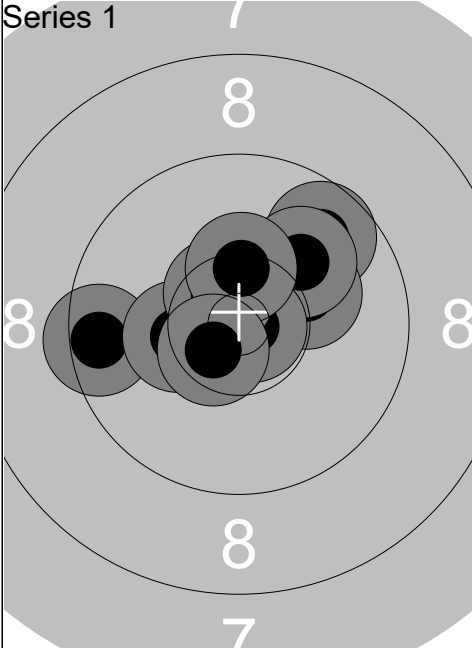
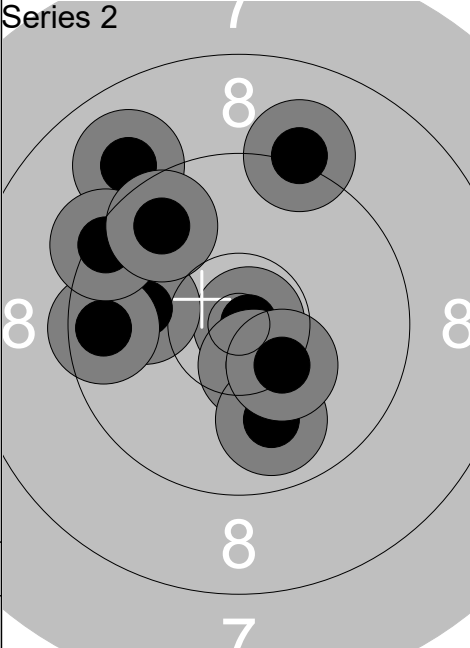
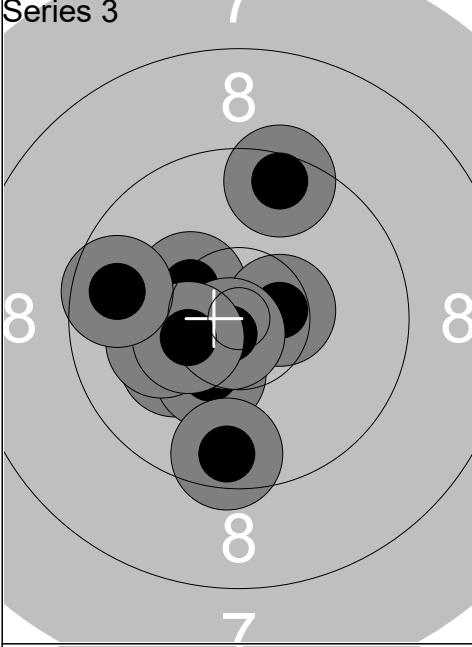
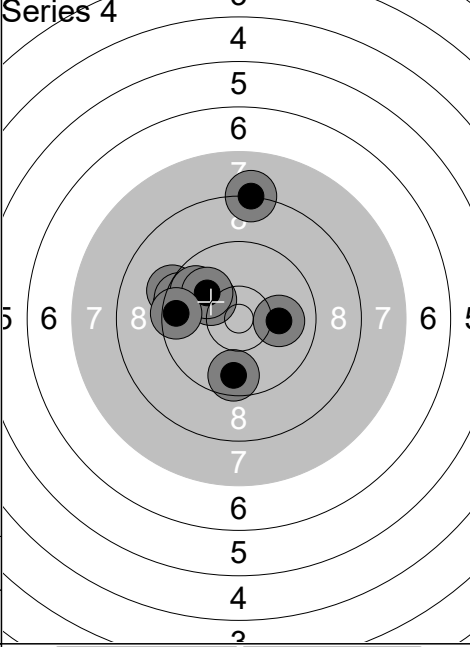
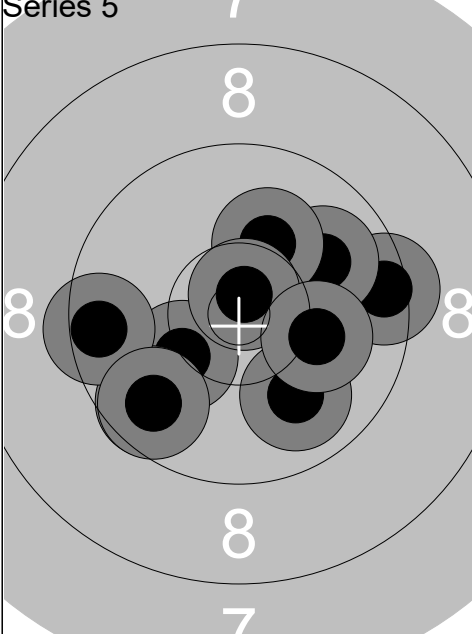
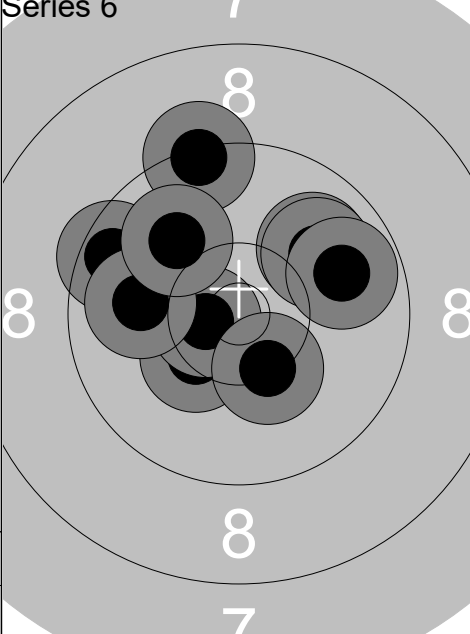
| Relay | Lane | Andreas Köppl | | |
|------------|--|-----------------------|--|-----------------------|
| 5 | 19 | GER | Mp | P |
| Qual Day 3 | | Denmark Open Air 2026 | | Denmark Open Air 2026 |
| 11.02.2026 | | | | |
| Series 1 |  | 1: 9.8 ↗ | Series 2 | 1: 10.8x → |
| | | 2: 9.5 ← |  | 2: 10.0 ← |
| | | 3: 10.2 → | | 3: 9.6 ← |
| | | 4: 10.8x ↑ | | 4: 10.5x ↓ |
| | | 5: 10.1 ↗ | | 5: 9.0 ↗ |
| | | 6: 10.3 ← | | 6: 9.1 ↗ |
| | | 7: 10.8x → | | 7: 9.9 ↓ |
| | | 8: 10.6x ↘ | | 8: 9.4 ↗ |
| | | 9: 10.4x ↑ | | 9: 10.4 ↓ |
| | | 10: 10.6x ↙ | | 10: 9.7 ↗ |
| | | Series 98 (5x) | | Series 94 (2x) |
| | | 98 (5x) | | 192 (7x) |
| Series 3 |  | 1: 10.2 ← | Series 4 | 1: 10.2 ↖ |
| | | 2: 10.4x ↖ |  | 2: 9.7 ↓ |
| | | 3: 10.5x → | | 3: 10.1 → |
| | | 4: 10.3 ↓ | | 4: 9.3 ↖ |
| | | 5: 10.8x ↙ | | 5: 9.6 ← |
| | | 6: 9.6 ↓ | | 6: 9.6 ← |
| | | 7: 10.1 ← | | 7: 8.2 ↑ |
| | | 8: 10.4x ← | | 8: 9.8 ↖ |
| | | 9: 9.7 ← | | 9: 10.0 ↗ |
| | | 10: 9.5 ↑ | | 10: 9.5 ← |
| | | Series 97 (4x) | | Series 92 (0x) |
| | | 289 (11x) | | 381 (11x) |
| Series 5 |  | 1: 10.2 ↖ | Series 6 | 1: 9.6 ↖ |
| | | 2: 9.7 ↖ |  | 2: 10.3 ↙ |
| | | 3: 10.0 ↓ | | 3: 10.0 ↗ |
| | | 4: 9.5 → | | 4: 10.6x ← |
| | | 5: 10.0 ↗ | | 5: 10.0 ↗ |
| | | 6: 10.2 ↑ | | 6: 10.3 ↓ |
| | | 7: 9.5 ← | | 7: 9.3 ↑ |
| | | 8: 9.7 ↙ | | 8: 10.0 ← |
| | | 9: 10.7x ↑ | | 9: 10.0 ↗ |
| | | 10: 10.1 → | | 10: 9.8 → |
| | | Series 96 (1x) | | Series 97 (1x) |
| | | 477 (12x) | | 574 (13x) |

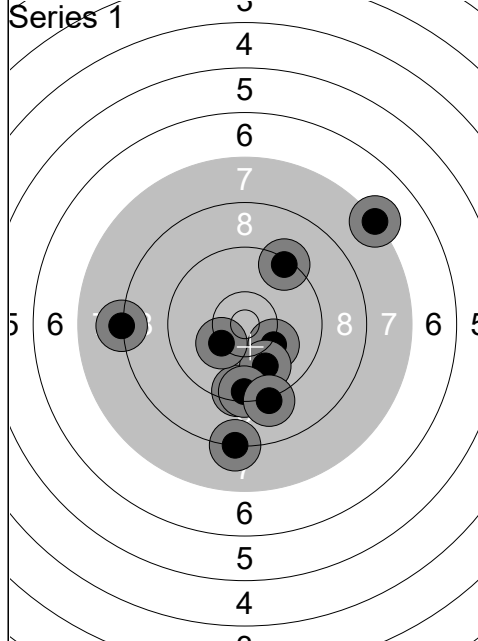

| |
|------------------------|
| 1: 9.5 ↓ |
| 2: 10.2 ↘ |
| 3: 9.3 ↗ |
| 4: 8.2 ← |
| 5: 9.9 ↓ |
| 6: 8.2 ↓ |
| 7: 9.5 ↓ |
| 8: 7.2 ↗ |
| 9: 10.3 ↙ |
| 10: 9.2 ↓ |
| Series 88 (0x) |
| 88 (0x) |

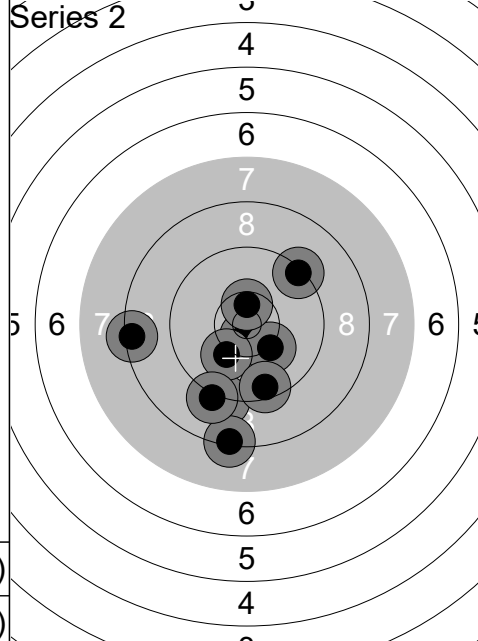

| |
|------------------------|
| 1: 10.7x ↓ |
| 2: 9.2 ↓ |
| 3: 8.4 ← |
| 4: 10.2 ↘ |
| 5: 10.5x ↑ |
| 6: 8.3 ↓ |
| 7: 10.1 ↘ |
| 8: 9.5 ↓ |
| 9: 9.3 ↗ |
| 10: 9.1 ↓ |
| Series 92 (2x) |
| 180 (2x) |

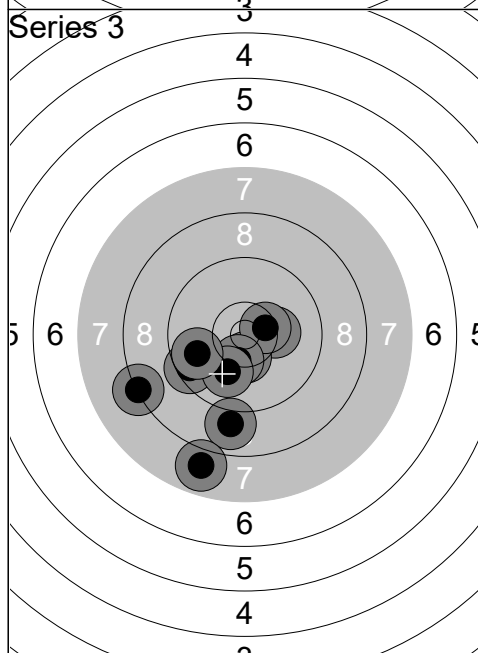

| |
|------------------------|
| 1: 10.3 → |
| 2: 10.5x ↓ |
| 3: 8.3 ← |
| 4: 10.5x → |
| 5: 8.9 ↓ |
| 6: 7.9 ↓ |
| 7: 10.4x ↓ |
| 8: 9.5 ← |
| 9: 10.0 ↓ |
| 10: 9.8 ← |
| Series 91 (3x) |
| 271 (5x) |

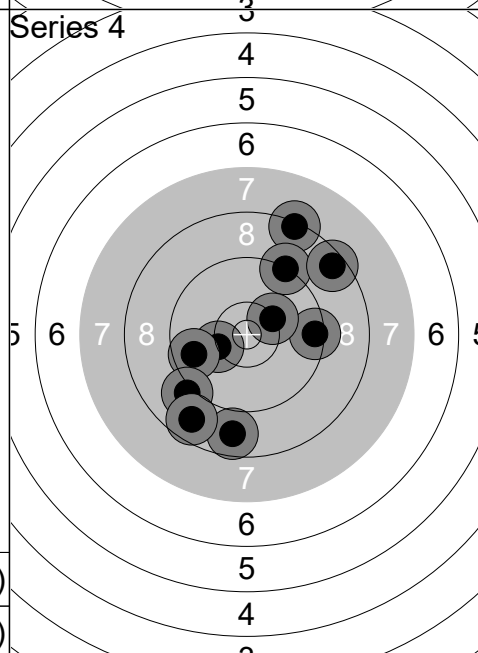

| |
|------------------------|
| 1: 8.3 ↗ |
| 2: 9.3 ↗ |
| 3: 8.5 ↗ |
| 4: 10.3 ← |
| 5: 9.7 ← |
| 6: 9.1 ↙ |
| 7: 9.4 → |
| 8: 8.7 ↓ |
| 9: 10.3 ↗ |
| 10: 8.7 ↙ |
| Series 88 (0x) |
| 359 (5x) |

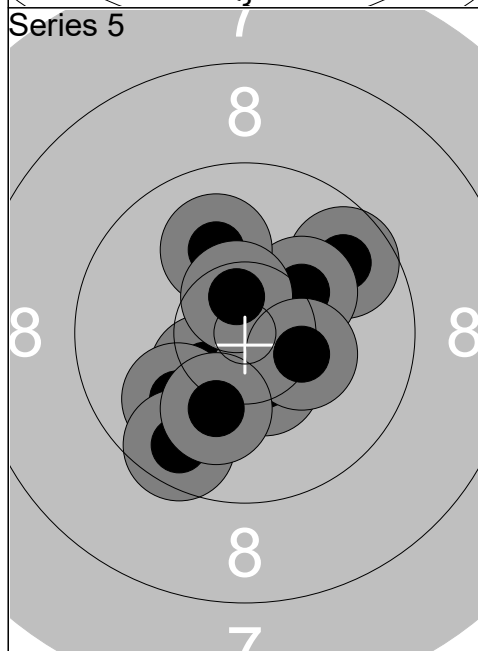

| |
|------------------------|
| 1: 10.4x ↙ |
| 2: 9.7 ↗ |
| 3: 10.2 ↗ |
| 4: 10.1 ↑ |
| 5: 10.0 ↙ |
| 6: 9.6 ↓ |
| 7: 10.4x ↓ |
| 8: 10.6x ↑ |
| 9: 10.3 → |
| 10: 10.1 ↓ |
| Series 98 (3x) |
| 457 (8x) |

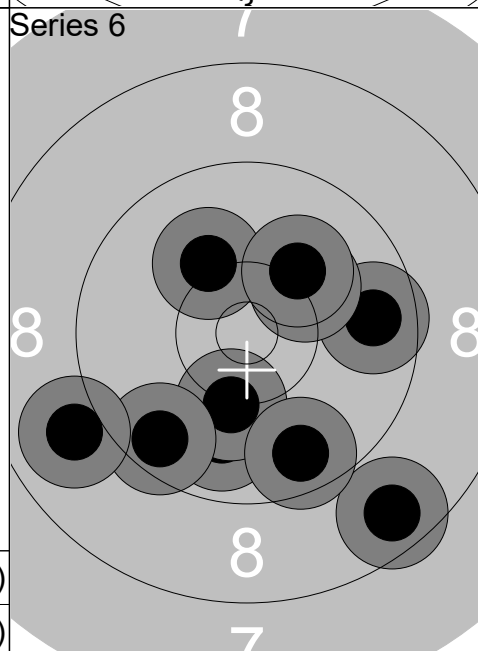

| |
|------------------------|
| 1: 9.9 ↓ |
| 2: 10.1 ↖ |
| 3: 10.2 ↓ |
| 4: 9.7 → |
| 5: 10.2 ↗ |
| 6: 8.6 ↘ |
| 7: 9.6 ↙ |
| 8: 8.9 ← |
| 9: 10.1 ↗ |
| 10: 9.6 ↓ |
| Series 92 (0x) |
| 549 (8x) |

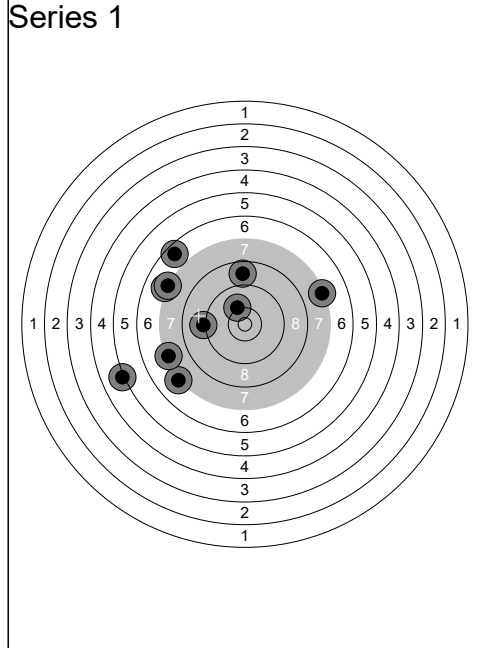

| | | |
|---------------|----------------|---|
| 1: | 5.2 | ← |
| 2: | 7.2 | ↙ |
| 3: | 7.3 | → |
| 4: | 7.1 | ↙ |
| 5: | 6.6 | ↘ |
| 6: | 9.1 | ← |
| 7: | 7.4 | ← |
| 8: | 7.2 | ↙ |
| 9: | 10.2 | ↗ |
| 10: | 8.7 | ↗ |
| Series | 73 (0x) | |
| | 73 (0x) | |

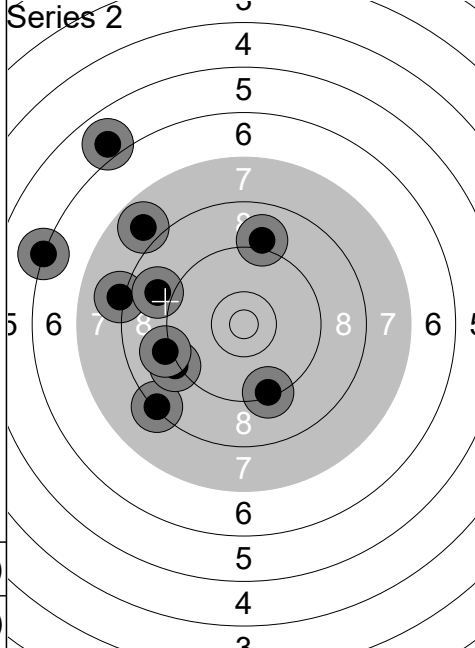

| | | |
|---------------|-----------------|---|
| 1: | 9.3 | ↘ |
| 2: | 8.3 | ↙ |
| 3: | 6.2 | ↙ |
| 4: | 9.2 | ↙ |
| 5: | 8.1 | ← |
| 6: | 9.1 | ↗ |
| 7: | 8.9 | ↙ |
| 8: | 5.9 | ↗ |
| 9: | 9.1 | ← |
| 10: | 7.8 | ↙ |
| Series | 78 (0x) | |
| | 151 (0x) | |

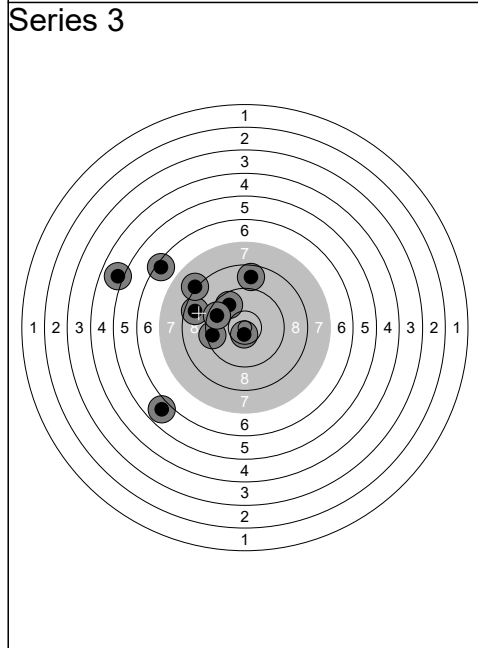

| | | |
|---------------|-----------------|---|
| 1: | 6.5 | ↙ |
| 2: | 10.6x | ↘ |
| 3: | 9.5 | ← |
| 4: | 9.7 | ↗ |
| 5: | 5.9 | ↙ |
| 6: | 8.6 | ← |
| 7: | 8.7 | ↗ |
| 8: | 5.0 | ← |
| 9: | 8.1 | ↙ |
| 10: | 9.6 | ↙ |
| Series | 77 (1x) | |
| | 228 (1x) | |

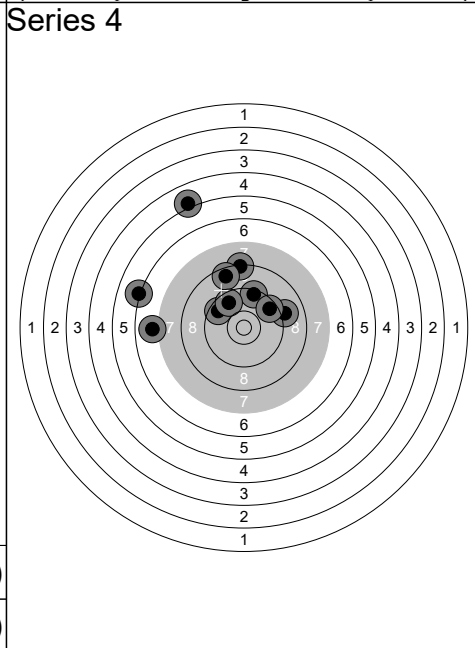

| | | |
|---------------|-----------------|---|
| 1: | 5.0 | ↗ |
| 2: | 7.0 | ← |
| 3: | 8.3 | ↗ |
| 4: | 8.6 | ↗ |
| 5: | 9.1 | → |
| 6: | 9.5 | ↗ |
| 7: | 9.6 | ↙ |
| 8: | 6.2 | ← |
| 9: | 9.6 | ↗ |
| 10: | 9.7 | ↙ |
| Series | 79 (0x) | |
| | 307 (1x) | |

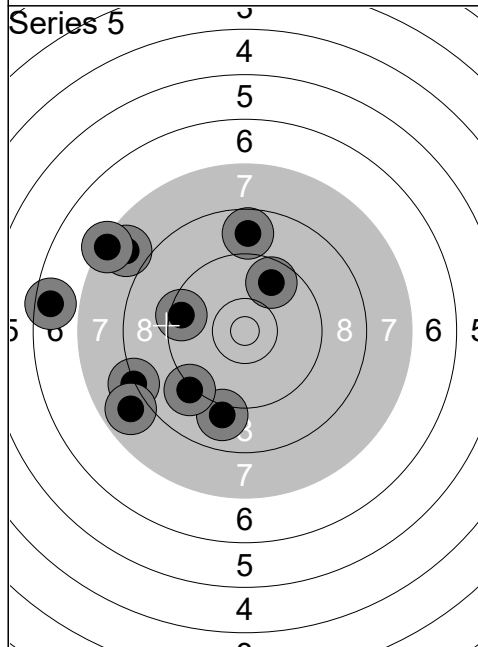

| | | |
|---------------|-----------------|---|
| 1: | 8.8 | ↗ |
| 2: | 7.8 | ↙ |
| 3: | 6.6 | ← |
| 4: | 9.0 | ↘ |
| 5: | 9.5 | ← |
| 6: | 7.4 | ↙ |
| 7: | 8.2 | ← |
| 8: | 7.9 | ↙ |
| 9: | 9.7 | ↗ |
| 10: | 9.1 | ↙ |
| Series | 79 (0x) | |
| | 386 (1x) | |

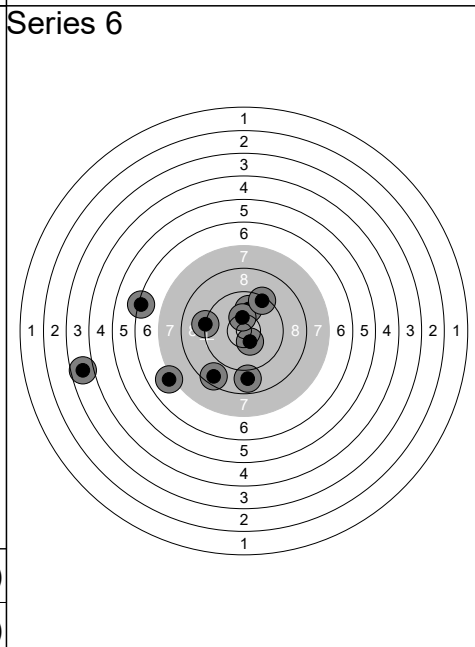

| | | |
|---------------|-----------------|---|
| 1: | 10.0 | ↗ |
| 2: | 9.3 | ← |
| 3: | 10.4x | ↘ |
| 4: | 6.3 | ← |
| 5: | 8.9 | ↘ |
| 6: | 10.4x | ↗ |
| 7: | 3.7 | ← |
| 8: | 9.4 | ↗ |
| 9: | 8.6 | ↙ |
| 10: | 7.1 | ← |
| Series | 80 (2x) | |
| | 466 (3x) | |

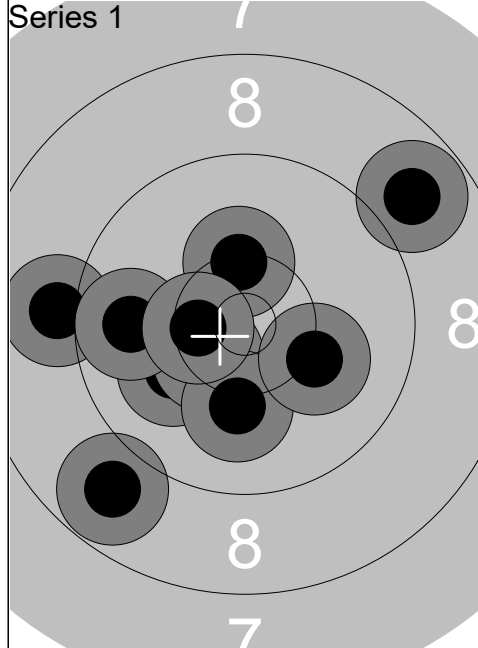

| | | |
|---------------|-----------------|---|
| 1: | 8.8 | ↘ |
| 2: | 10.1 | ↙ |
| 3: | 10.5x | ↙ |
| 4: | 9.1 | ← |
| 5: | 9.8 | ← |
| 6: | 10.3 | ↑ |
| 7: | 8.8 | ↗ |
| 8: | 10.1 | ↓ |
| 9: | 10.5x | ↙ |
| 10: | 10.2 | ↘ |
| Series | 94 (2x) | |
| | 94 (2x) | |

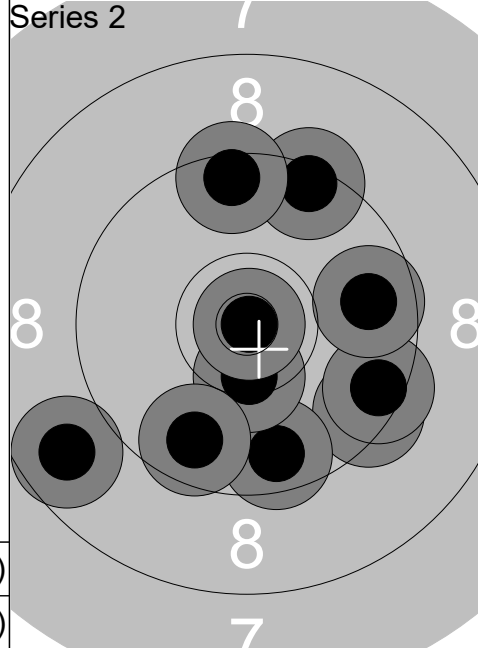

| | | |
|---------------|------------------|---|
| 1: | 9.4 | ↘ |
| 2: | 9.5 | ↘ |
| 3: | 9.6 | ↓ |
| 4: | 10.4x | ↓ |
| 5: | 9.4 | ↗ |
| 6: | 9.7 | → |
| 7: | 9.5 | ↑ |
| 8: | 8.7 | ↙ |
| 9: | 10.9x | → |
| 10: | 9.7 | ↓ |
| Series | 91 (2x) | |
| | 185 (4x) | |

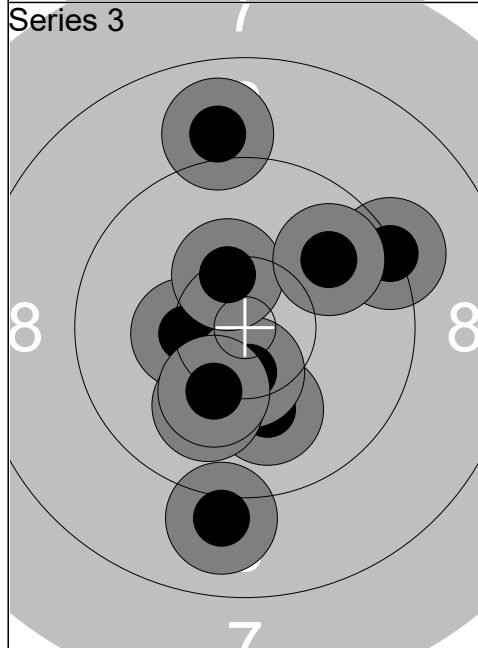

| | | |
|---------------|------------------|---|
| 1: | 10.4x | ← |
| 2: | 10.1 | ↓ |
| 3: | 10.5x | ↓ |
| 4: | 10.1 | ↓ |
| 5: | 9.0 | ↑ |
| 6: | 10.4x | ↑ |
| 7: | 9.3 | ↗ |
| 8: | 9.0 | ↓ |
| 9: | 10.2 | ↓ |
| 10: | 9.9 | ↗ |
| Series | 96 (3x) | |
| | 281 (7x) | |

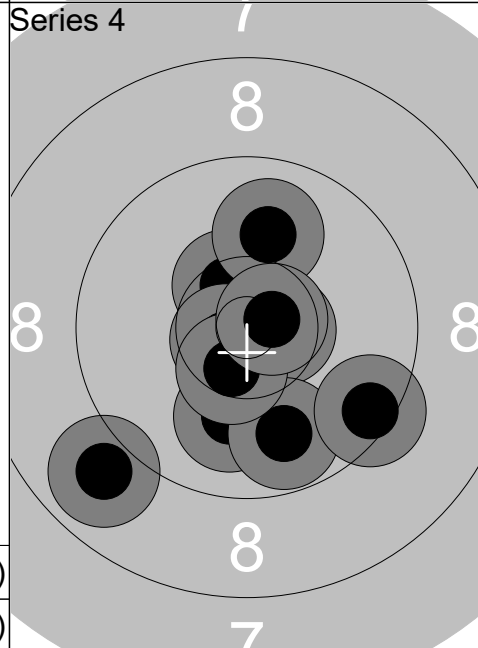

| | | |
|---------------|------------------|---|
| 1: | 10.0 | ↓ |
| 2: | 8.9 | ↙ |
| 3: | 10.6x | → |
| 4: | 9.8 | ↓ |
| 5: | 10.5x | ↗ |
| 6: | 10.7x | ↙ |
| 7: | 10.5x | ↓ |
| 8: | 9.5 | ↘ |
| 9: | 10.0 | ↑ |
| 10: | 10.7x | → |
| Series | 96 (5x) | |
| | 377 (12x) | |

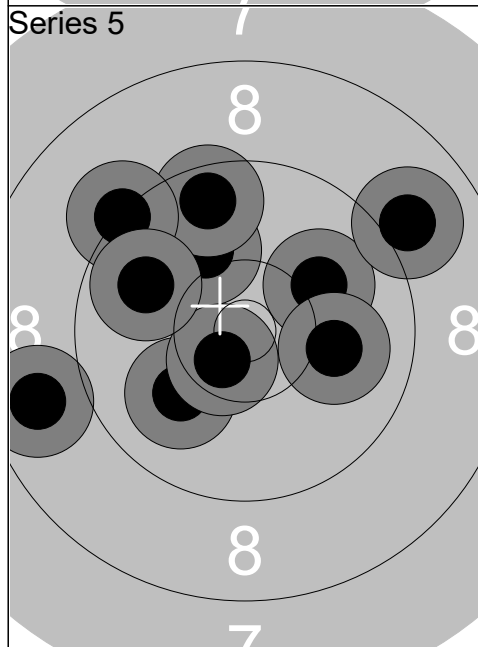

| | | |
|---------------|------------------|---|
| 1: | 10.1 | ↗ |
| 2: | 10.1 | ↗ |
| 3: | 9.6 | ↑ |
| 4: | 9.0 | ↗ |
| 5: | 10.0 | ↙ |
| 6: | 9.3 | ↙ |
| 7: | 8.7 | ← |
| 8: | 10.6x | ↙ |
| 9: | 10.0 | → |
| 10: | 9.8 | ← |
| Series | 94 (1x) | |
| | 471 (13x) | |

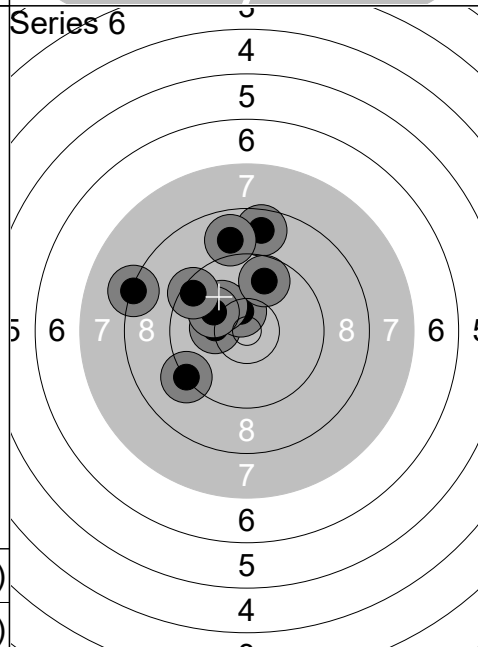

| | | |
|---------------|------------------|---|
| 1: | 10.2 | ← |
| 2: | 10.5x | ↑ |
| 3: | 8.7 | ↑ |
| 4: | 8.3 | ← |
| 5: | 8.9 | ↑ |
| 6: | 10.2 | ↙ |
| 7: | 10.1 | ↙ |
| 8: | 9.8 | ↑ |
| 9: | 9.5 | ↙ |
| 10: | 9.3 | ↙ |
| Series | 91 (1x) | |
| | 562 (14x) | |

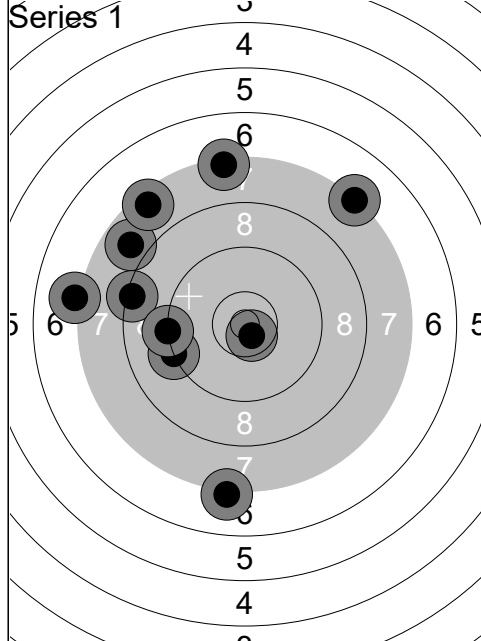

| |
|------------------------|
| 1: 7.9 ↖ |
| 2: 10.7x ↘ |
| 3: 7.5 ↗ |
| 4: 8.4 ← |
| 5: 7.3 ↗ |
| 6: 7.4 ↑ |
| 7: 9.2 ← |
| 8: 9.2 ← |
| 9: 7.1 ← |
| 10: 7.1 ↓ |
| Series 78 (1x) |
| 78 (1x) |

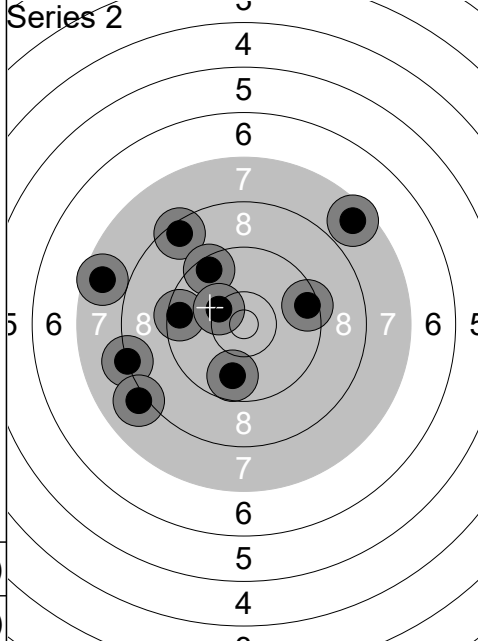

| |
|------------------------|
| 1: 9.5 ← |
| 2: 7.6 ↗ |
| 3: 7.6 ← |
| 4: 8.5 ↗ |
| 5: 8.2 ← |
| 6: 8.1 ↖ |
| 7: 9.8 ↓ |
| 8: 9.5 ↗ |
| 9: 10.3 ↖ |
| 10: 9.5 → |
| Series 84 (0x) |
| 162 (1x) |

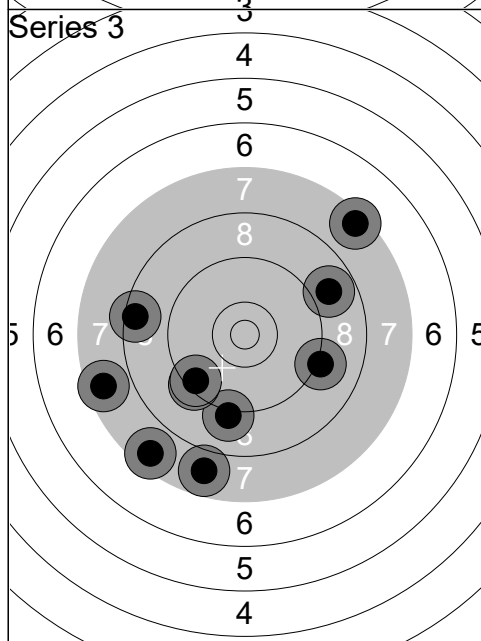

| |
|------------------------|
| 1: 7.6 ↖ |
| 2: 9.1 ↓ |
| 3: 7.5 ↗ |
| 4: 8.9 ↗ |
| 5: 9.4 ↖ |
| 6: 9.1 → |
| 7: 9.5 ↖ |
| 8: 7.6 ← |
| 9: 7.8 ↓ |
| 10: 8.5 ← |
| Series 80 (0x) |
| 242 (1x) |

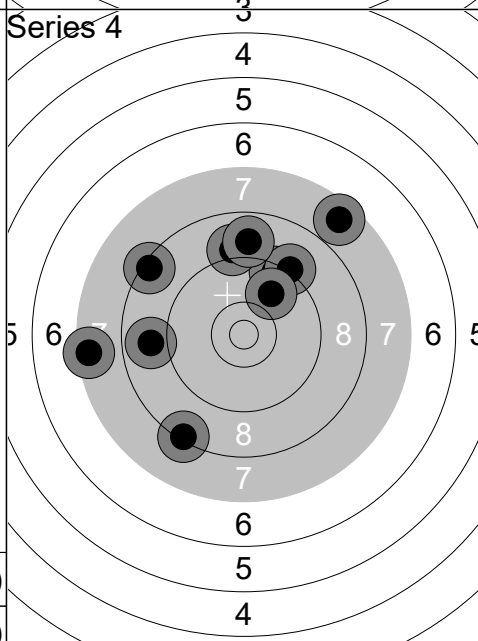

| |
|------------------------|
| 1: 7.6 ↗ |
| 2: 9.4 ↗ |
| 3: 8.4 ↖ |
| 4: 7.5 ← |
| 5: 8.9 ← |
| 6: 9.2 ↗ |
| 7: 9.1 ↑ |
| 8: 8.9 ↑ |
| 9: 9.8 ↗ |
| 10: 8.3 ↓ |
| Series 82 (0x) |
| 324 (1x) |

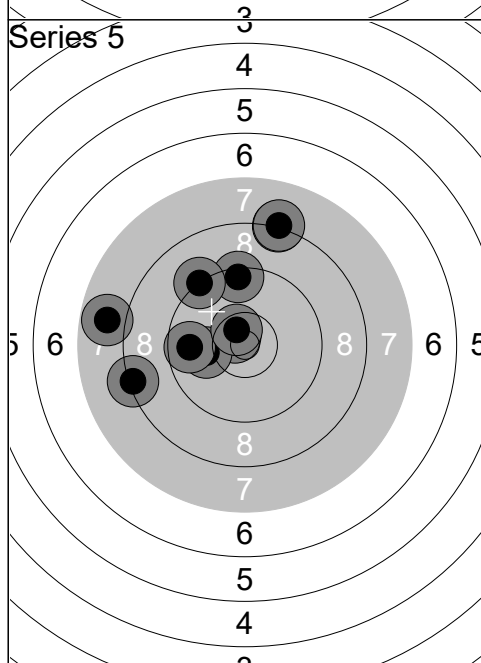

| |
|------------------------|
| 1: 9.4 ↑ |
| 2: 8.2 ↑ |
| 3: 8.3 ← |
| 4: 10.7x ↖ |
| 5: 10.1 ← |
| 6: 7.8 ← |
| 7: 8.2 ↑ |
| 8: 9.7 ← |
| 9: 9.2 ↗ |
| 10: 10.6x ↖ |
| Series 88 (2x) |
| 412 (3x) |

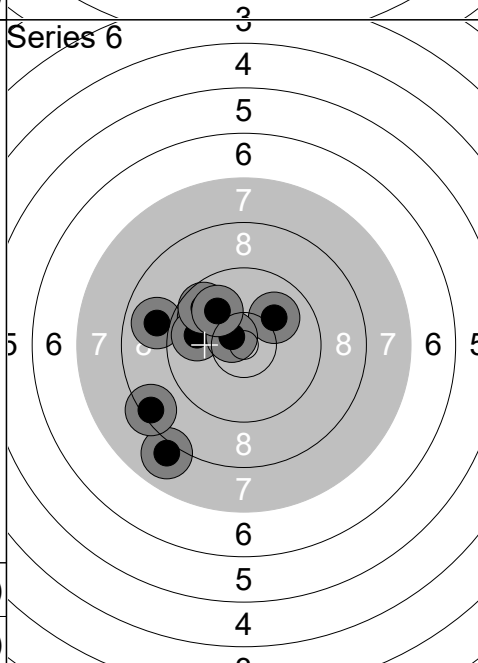

| |
|------------------------|
| 1: 10.1 ↖ |
| 2: 9.0 ← |
| 3: 10.0 ↗ |
| 4: 9.9 ↖ |
| 5: 8.0 ↓ |
| 6: 9.9 ← |
| 7: 8.4 ↖ |
| 8: 9.7 ↗ |
| 9: 10.6x ↖ |
| 10: 10.0 ↖ |
| Series 92 (1x) |
| 504 (4x) |

| Relay | Lane | Pontus Rinaldo | |
|------------|-----------------|-----------------------|-----------------------|
| 5 | 27 | | |
| Qual Day 3 | | SWE | Mp P |
| 11.02.2026 | | Denmark Open Air 2026 | Denmark Open Air 2026 |
| | 1: 8.4 ↗ | | 1: 9.0 ↖ |
| | 2: 9.1 ↖ | | 2: 9.6 ↘ |
| | 3: 10.3 → | | 3: 10.0 ↘ |
| | 4: 10.1 ↗ | | 4: 10.1 ↗ |
| | 5: 8.6 ↘ | | 5: 9.1 ↖ |
| | 6: 10.1 ↗ | | 6: 9.6 ↘ |
| | 7: 8.4 ↗ | | 7: 10.1 ↘ |
| | 8: 10.1 ↗ | | 8: 10.3 ↖ |
| | 9: 10.0 ↖ | | 9: 9.8 ↗ |
| | 10: 8.7 ↘ | | 10: 10.4x ↘ |
| | Series 91 (0x) | | Series 95 (1x) |
| 91 (0x) | 186 (1x) | | |
| | 1: 9.2 ↘ | | 1: 10.6x ↘ |
| | 2: 7.4 ↘ | | 2: 8.9 ↗ |
| | 3: 10.1 ↖ | | 3: 10.2 ↖ |
| | 4: 9.0 ↘ | | 4: 9.9 ↘ |
| | 5: 9.5 ↘ | | 5: 10.4x ↗ |
| | 6: 9.7 ↘ | | 6: 9.8 ↖ |
| | 7: 9.2 ↖ | | 7: 7.1 ↖ |
| | 8: 9.4 ↖ | | 8: 9.6 ↘ |
| | 9: 9.9 → | | 9: 10.2 ↘ |
| | 10: 10.4x ↗ | | 10: 9.1 ↖ |
| | Series 90 (1x) | | Series 91 (2x) |
| 276 (2x) | 367 (4x) | | |
| | 1: 9.8 → | | 1: 9.2 ↖ |
| | 2: 9.8 → | | 2: 9.9 → |
| | 3: 10.2 ↘ | | 3: 8.8 ↖ |
| | 4: 10.6x ↘ | | 4: 9.9 ↗ |
| | 5: 9.7 ↘ | | 5: 9.9 ↗ |
| | 6: 9.7 ↖ | | 6: 9.5 ↘ |
| | 7: 8.2 ↖ | | 7: 10.7x → |
| | 8: 8.2 ↖ | | 8: 10.2 ↖ |
| | 9: 8.9 ↘ | | 9: 9.4 ↘ |
| | 10: 10.5x ↖ | | 10: 9.0 ↗ |
| | Series 90 (2x) | | Series 91 (1x) |
| 457 (6x) | 548 (7x) | | |

| Relay | Lane | Stuart Burns | | |
|------------|-----------------------|-----------------------|----------|-----------------|
| 5 | 28 | CAN | Mp | P |
| 11.02.2026 | Denmark Open Air 2026 | Denmark Open Air 2026 | | |
| Series 1 | | 1: 10.0 ↗ | Series 2 | 1: 10.2 ↑ |
| | | 2: 9.6 ➡ | | 2: 9.2 ↑ |
| | | 3: 6.2 ↗ | | 3: 8.1 ↘ |
| | | 4: 9.6 ↗ | | 4: 9.1 ↘ |
| | | 5: 10.2 ↖ | | 5: 10.5x ↓ |
| | | 6: 8.9 ← | | 6: 10.0 ↓ |
| | | 7: 10.7x ↘ | | 7: 10.1 ➡ |
| | | 8: 9.7 ↓ | | 8: 7.7 ↙ |
| | | 9: 9.8 ➡ | | 9: 9.4 ↑ |
| | | 10: 7.3 ↓ | | 10: 8.1 ↘ |
| | | Series 87 (1x) | | Series 90 (1x) |
| | | 87 (1x) | | 177 (2x) |
| Series 3 | | 1: 8.3 ↗ | Series 4 | 1: 9.2 ↑ |
| | | 2: 10.2 ↑ | | 2: 8.5 ↗ |
| | | 3: 9.9 ↗ | | 3: 9.4 ↘ |
| | | 4: 8.8 ↑ | | 4: 9.9 ↗ |
| | | 5: 9.9 ↘ | | 5: 10.0 ➡ |
| | | 6: 8.9 ↗ | | 6: 8.6 ↗ |
| | | 7: 9.7 ↗ | | 7: 10.3 ↓ |
| | | 8: 8.1 ↗ | | 8: 9.9 ↖ |
| | | 9: 10.4x ➡ | | 9: 8.4 ↙ |
| | | 10: 10.7x ↖ | | 10: 10.3 ↙ |
| | | Series 89 (2x) | | Series 90 (0x) |
| | | 266 (4x) | | 356 (4x) |
| Series 5 | | 1: 10.8x ↑ | Series 6 | 1: 10.4x ↑ |
| | | 2: 10.1 ↘ | | 2: 10.0 ↓ |
| | | 3: 9.8 ↖ | | 3: 9.2 ↓ |
| | | 4: 10.2 ↗ | | 4: 10.4x ↑ |
| | | 5: 10.4x ↖ | | 5: 8.9 ↖ |
| | | 6: 9.3 ← | | 6: 9.1 ↘ |
| | | 7: 7.8 ↓ | | 7: 10.4 ↓ |
| | | 8: 7.4 ↑ | | 8: 10.5x ↖ |
| | | 9: 10.2 ↖ | | 9: 9.4 ← |
| | | 10: 9.1 ➡ | | 10: 9.9 ← |
| | | Series 91 (2x) | | Series 94 (3x) |
| | | 447 (6x) | | 541 (9x) |

| Relay | Lane | Glenn Hicks | | | | | |
|---------------------|------|-----------------------|---|-----------------------|-----|-----------|---|
| 5 | 30 | CAN | | Mp | P | | |
| 11.02.2026 | | Denmark Open Air 2026 | | Denmark Open Air 2026 | | | |
| Series 1 | 1: | 9.1 | ↑ | Series 2 | 1: | 9.5 | ↘ |
| | 2: | 8.2 | ↗ | | 2: | 9.6 | → |
| | 3: | 8.2 | ↑ | | 3: | 9.5 | ↗ |
| | 4: | 8.6 | ↙ | | 4: | 8.1 | ↗ |
| | 5: | 10.3 | ↗ | | 5: | 10.0 | ↓ |
| | 6: | 8.9 | ← | | 6: | 10.6x | ↓ |
| | 7: | 8.6 | ← | | 7: | 8.4 | ← |
| | 8: | 8.6 | ↓ | | 8: | 8.8 | ↑ |
| | 9: | 8.5 | ↙ | | 9: | 9.7 | ↘ |
| | 10: | 9.6 | ↓ | | 10: | 10.4x | ↗ |
| Series | | 84 (0x) | | Series | | 90 (2x) | |
| | | 84 (0x) | | | | 174 (2x) | |
| Series 3 | 1: | 10.0 | ↘ | Series 4 | 1: | 9.4 | ↑ |
| | 2: | 10.4x | → | | 2: | 8.8 | ↗ |
| | 3: | 9.3 | ↙ | | 3: | 8.8 | ← |
| | 4: | 8.6 | ↓ | | 4: | 9.3 | ↗ |
| | 5: | 7.6 | ↑ | | 5: | 8.7 | ↗ |
| | 6: | 9.8 | ↓ | | 6: | 9.7 | → |
| | 7: | 9.4 | ← | | 7: | 8.7 | ↑ |
| | 8: | 8.8 | ↘ | | 8: | 7.2 | ↖ |
| | 9: | 9.2 | ↑ | | 9: | 9.9 | ↓ |
| | 10: | 10.4x | ↖ | | 10: | 8.7 | ← |
| Series | | 89 (2x) | | Series | | 83 (0x) | |
| | | 263 (4x) | | | | 346 (4x) | |
| Series 5 | 1: | 8.9 | ↑ | Series 6 | 1: | 9.5 | ← |
| | 2: | 8.5 | ↗ | | 2: | 9.7 | ↓ |
| | 3: | 9.0 | ← | | 3: | 8.9 | ↗ |
| | 4: | 9.7 | ← | | 4: | 9.2 | ↓ |
| | 5: | 8.9 | ↓ | | 5: | 8.5 | ↙ |
| | 6: | 9.0 | ← | | 6: | 7.1 | ↑ |
| | 7: | 9.3 | → | | 7: | 9.2 | → |
| | 8: | 9.4 | ↓ | | 8: | 10.1 | ↓ |
| | 9: | 9.3 | ↙ | | 9: | 9.0 | ↙ |
| | 10: | 8.5 | ↑ | | 10: | 8.7 | ↗ |
| Series | | 86 (0x) | | Series | | 86 (0x) | |
| | | 432 (4x) | | | | 518 (4x) | |

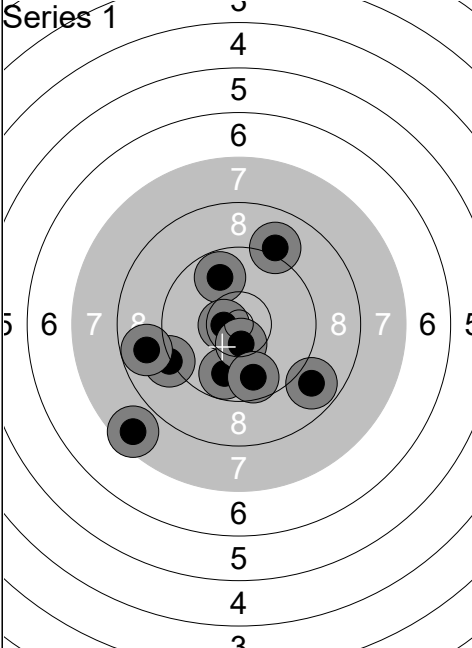
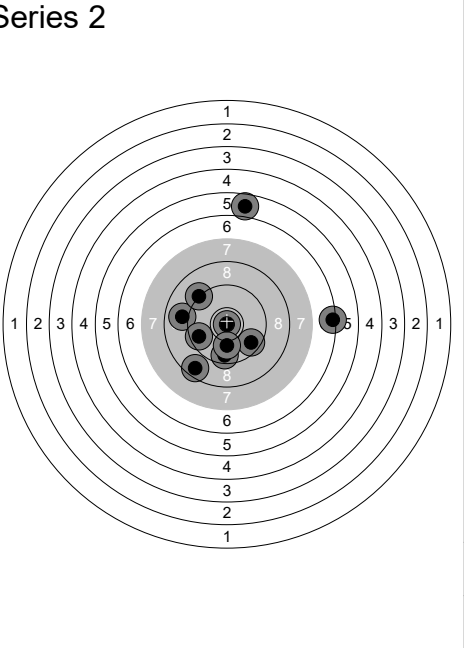
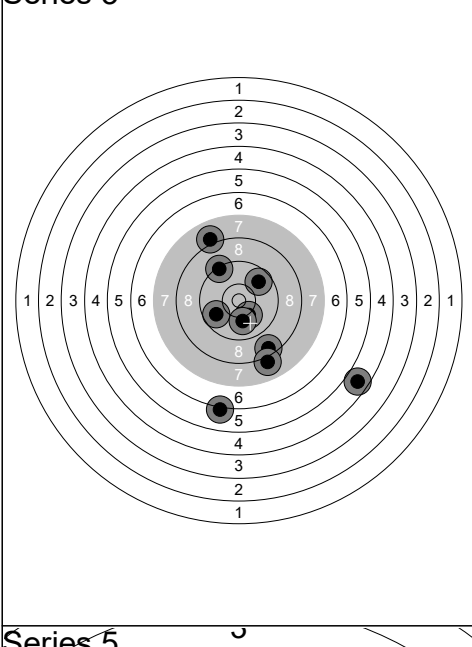
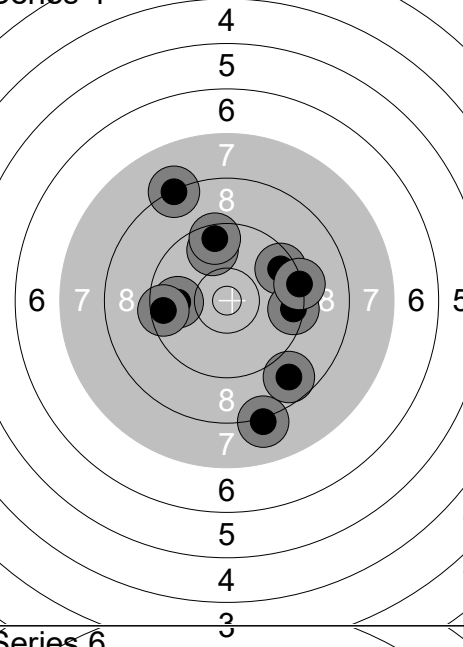
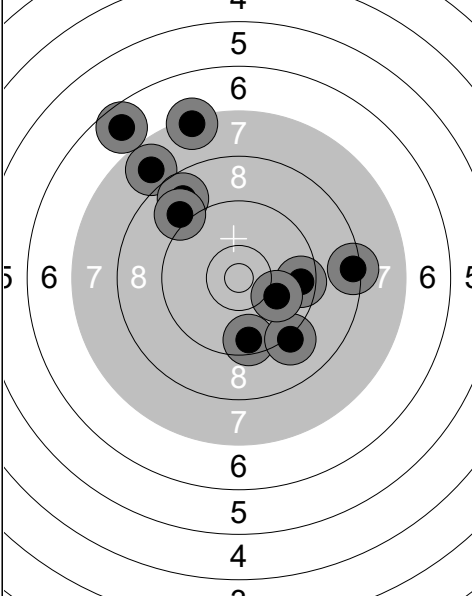
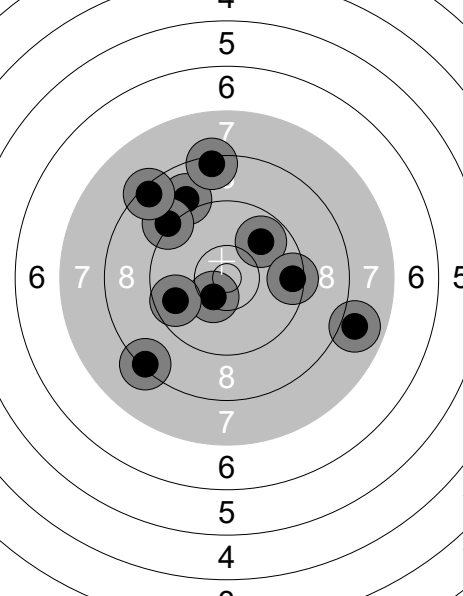
| Relay | Lane | Kasper Elbo | | |
|---|------------------------|---|------------------------|---|
| 5 | 31 | DEN | Mp | P |
| 11.02.2026 | Denmark Open Air 2026 | Denmark Open Air 2026 | | |
| Series 1  | 1: 9.8 ↓ | Series 2  | 1: 8.6 ↙ | |
| | 2: 9.2 ↙ | | 2: 6.3 → | |
| | 3: 8.8 ← | | 3: 10.9x ↙ | |
| | 4: 9.8 ↑ | | 4: 9.6 ↓ | |
| | 5: 8.9 ↘ | | 5: 9.0 ← | |
| | 6: 10.6x ← | | 6: 5.7 ↑ | |
| | 7: 9.1 ↑ | | 7: 9.6 ↘ | |
| | 8: 10.5x ↓ | | 8: 9.6 ← | |
| | 9: 7.6 ↙ | | 9: 10.0 ↓ | |
| | 10: 9.7 ↓ | | 10: 9.2 ↙ | |
| | Series 88 (2x) | | Series 84 (1x) | |
| | 88 (2x) | | 172 (3x) | |
| Series 3  | 1: 9.8 ↗ | Series 4  | 1: 9.8 ↑ | |
| | 2: 9.8 ↙ | | 2: 8.1 ↓ | |
| | 3: 8.5 ↓ | | 3: 9.6 ↗ | |
| | 4: 9.3 ↗ | | 4: 8.8 ↓ | |
| | 5: 6.2 ↓ | | 5: 9.9 ← | |
| | 6: 10.2 ↓ | | 6: 9.5 ← | |
| | 7: 4.7 ↘ | | 7: 8.3 ↑ | |
| | 8: 8.0 ↗ | | 8: 9.5 → | |
| | 9: 10.1 ↓ | | 9: 9.6 ↑ | |
| | 10: 8.0 ↓ | | 10: 9.3 → | |
| | Series 81 (0x) | | Series 87 (0x) | |
| | 253 (3x) | | 340 (3x) | |
| Series 5  | 1: 9.6 → | Series 6  | 1: 9.0 ↖ | |
| | 2: 7.8 ↗ | | 2: 10.4x ↙ | |
| | 3: 9.5 ↓ | | 3: 9.2 ↗ | |
| | 4: 6.7 ↗ | | 4: 7.9 → | |
| | 5: 9.2 ↘ | | 5: 9.7 ← | |
| | 6: 8.8 ↗ | | 6: 8.4 ↑ | |
| | 7: 8.4 → | | 7: 9.8 ↗ | |
| | 8: 7.4 ↗ | | 8: 8.3 ↙ | |
| | 9: 9.0 ↗ | | 9: 8.4 ↖ | |
| | 10: 10.0 → | | 10: 9.5 → | |
| | Series 82 (0x) | | Series 86 (1x) | |
| | 422 (3x) | | 508 (4x) | |

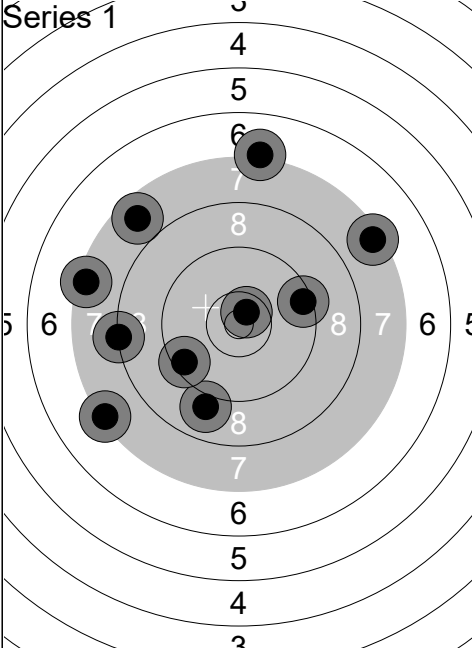
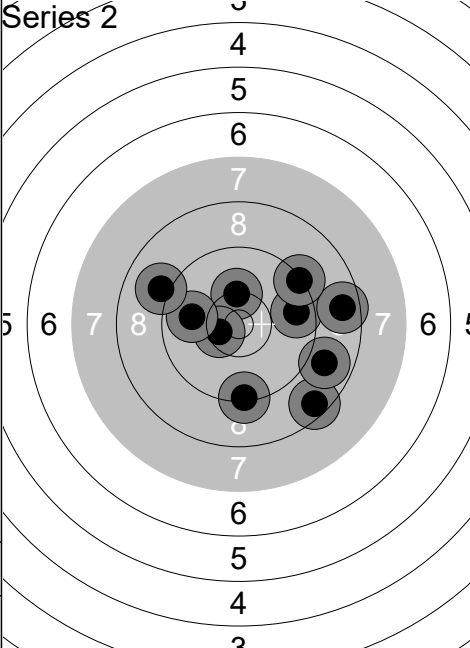
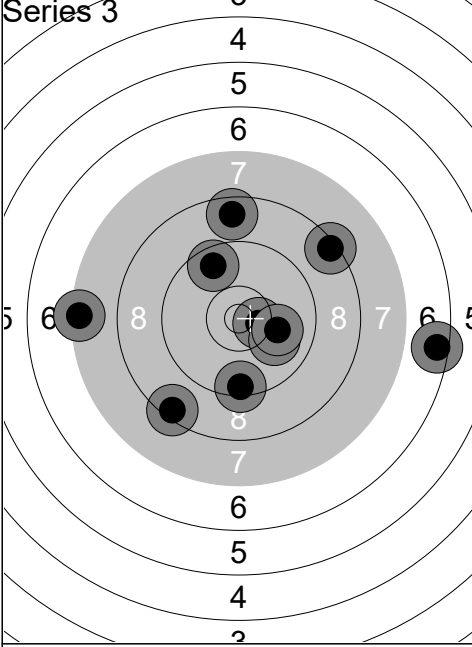
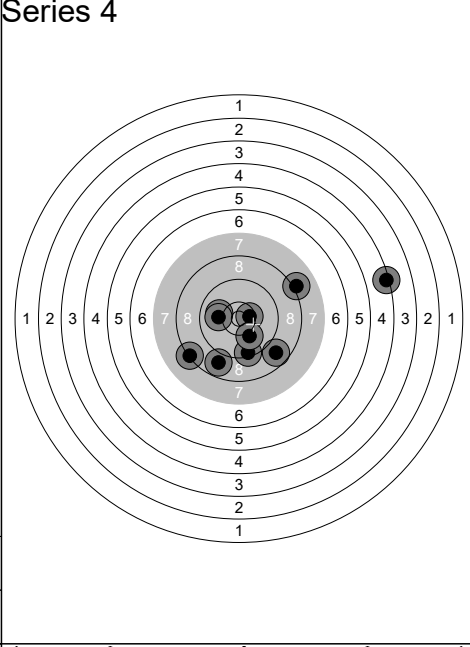
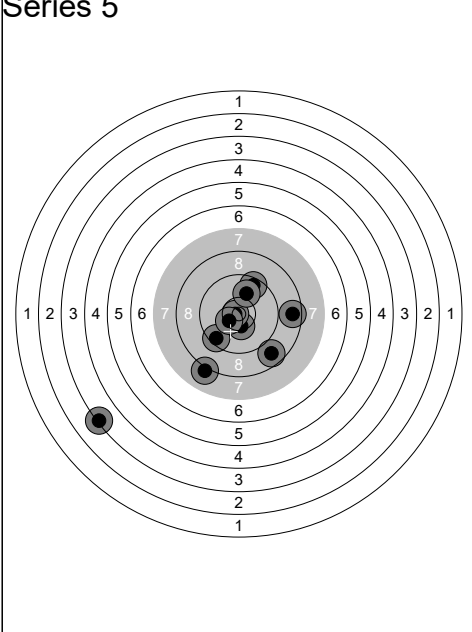
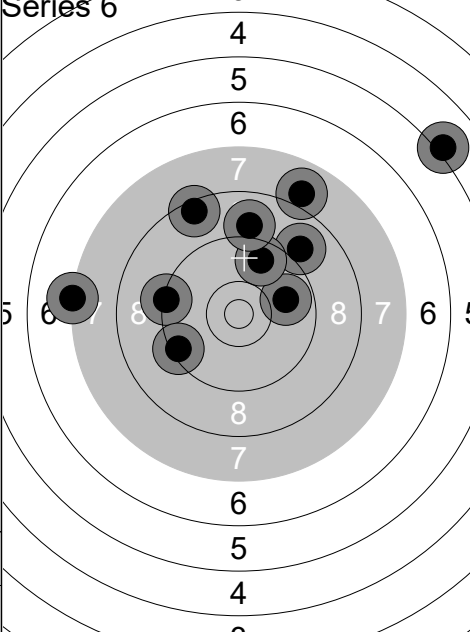
| Relay | Lane | Morten Kristiansen | | | |
|------------|--|-----------------------|----------|--|-----------------|
| 5 | 32 | DEN | Mp | P | |
| Qual Day 3 | | Denmark Open Air 2026 | | Denmark Open Air 2026 | |
| 11.02.2026 | | | | | |
| Series 1 |  | 1: 8.3 ← | Series 2 |  | 1: 10.3 ↑ |
| | | 2: 9.0 ↓ | | | 2: 9.3 ↓ |
| | | 3: 7.3 ← | | | 3: 9.6 → |
| | | 4: 10.6x ↗ | | | 4: 8.6 → |
| | | 5: 7.7 ↖ | | | 5: 8.5 ↘ |
| | | 6: 7.1 ↑ | | | 6: 9.3 ↗ |
| | | 7: 9.5 ← | | | 7: 10.5x ← |
| | | 8: 9.4 → | | | 8: 9.9 ← |
| | | 9: 7.4 ↗ | | | 9: 8.9 ↘ |
| | | 10: 7.4 ← | | | 10: 9.0 ← |
| | | Series 80 (1x) | | | Series 89 (1x) |
| | | 80 (1x) | | | 169 (2x) |
| Series 3 |  | 1: 7.4 ← | Series 4 |  | 1: 4.3 → |
| | | 2: 8.4 ↗ | | | 2: 8.8 ↘ |
| | | 3: 8.4 ↘ | | | 3: 8.3 ← |
| | | 4: 9.6 ↖ | | | 4: 10.1 ← |
| | | 5: 10.5x → | | | 5: 9.4 ↓ |
| | | 6: 10.0 ↘ | | | 6: 8.1 ↗ |
| | | 7: 6.5 → | | | 7: 10.1 ← |
| | | 8: 9.4 ↓ | | | 8: 10.5x → |
| | | 9: 8.6 ↑ | | | 9: 8.9 ↓ |
| | | 10: 10.1 → | | | 10: 10.1 ↘ |
| | | Series 85 (1x) | | | Series 85 (1x) |
| | | 254 (3x) | | | 339 (4x) |
| Series 5 |  | 1: 8.6 → | Series 6 |  | 1: 9.0 ↗ |
| | | 2: 9.5 ↗ | | | 2: 7.9 ↗ |
| | | 3: 10.4x ↓ | | | 3: 5.1 ↗ |
| | | 4: 3.3 ← | | | 4: 9.3 ← |
| | | 5: 8.1 ↘ | | | 5: 9.9 → |
| | | 6: 9.5 ↘ | | | 6: 9.4 ← |
| | | 7: 8.7 ↘ | | | 7: 8.5 ↑ |
| | | 8: 10.8x ← | | | 8: 7.2 ← |
| | | 9: 10.0 ↑ | | | 9: 9.7 ↑ |
| | | 10: 10.4x ← | | | 10: 9.0 ↑ |
| | | Series 85 (3x) | | | Series 81 (0x) |
| | | 424 (7x) | | | 505 (7x) |

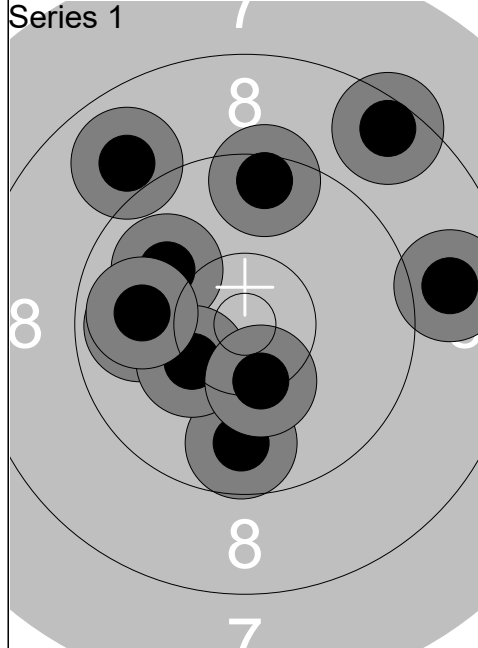

| | | |
|---------------|-----------------|---|
| 1: | 9.8 | ↓ |
| 2: | 9.9 | ← |
| 3: | 8.5 | ↗ |
| 4: | 9.5 | ↑ |
| 5: | 10.0 | ↖ |
| 6: | 10.3 | ↙ |
| 7: | 8.9 | ↗ |
| 8: | 9.9 | ← |
| 9: | 10.4 | ↓ |
| 10: | 8.9 | → |
| Series | 90 (0x) | |
| | 90 (0x) | |

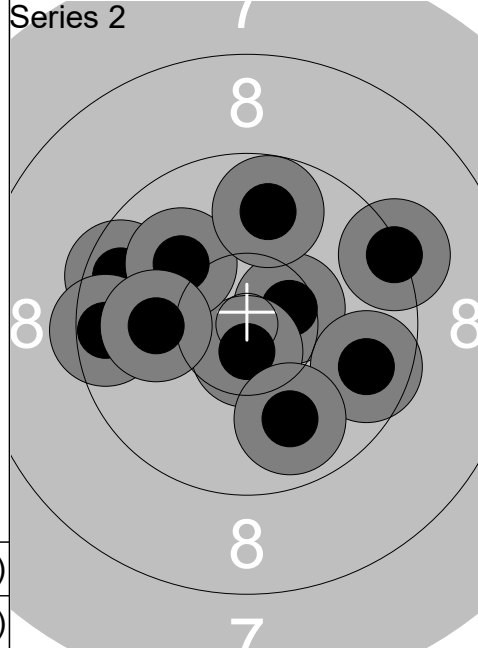

| | | |
|---------------|------------------|---|
| 1: | 9.6 | ↖ |
| 2: | 10.5x | → |
| 3: | 10.7x | ↓ |
| 4: | 10.0 | ↖ |
| 5: | 9.5 | ← |
| 6: | 9.8 | ↑ |
| 7: | 9.7 | → |
| 8: | 10.0 | ← |
| 9: | 9.3 | → |
| 10: | 9.9 | ↓ |
| Series | 94 (2x) | |
| | 184 (2x) | |

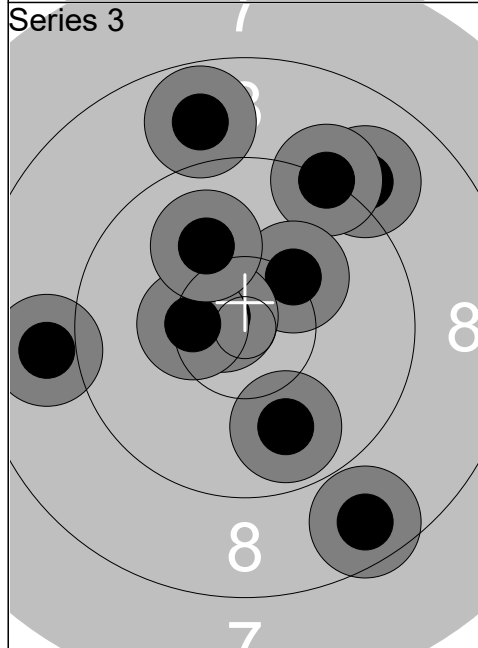

| | | |
|---------------|------------------|---|
| 1: | 9.0 | ↗ |
| 2: | 9.2 | ↗ |
| 3: | 10.2 | ↗ |
| 4: | 8.6 | ↓ |
| 5: | 9.9 | ↓ |
| 6: | 10.7x | ↖ |
| 7: | 8.8 | ↑ |
| 8: | 10.4x | ← |
| 9: | 8.9 | ← |
| 10: | 10.0 | ↖ |
| Series | 91 (2x) | |
| | 275 (4x) | |

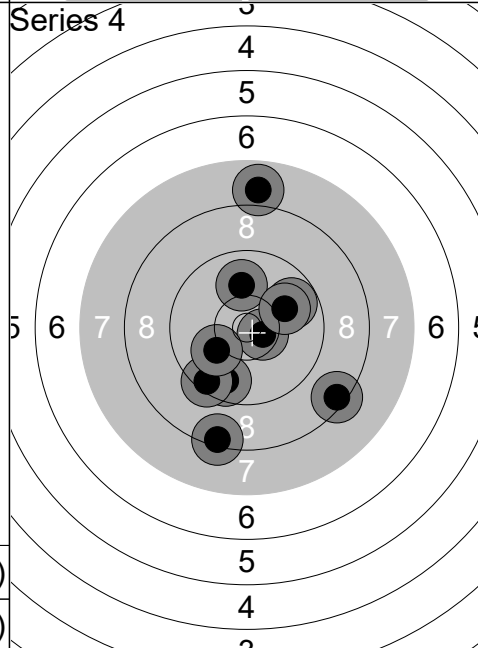

| | | |
|---------------|------------------|---|
| 1: | 9.8 | ↗ |
| 2: | 9.7 | ↓ |
| 3: | 8.4 | ↓ |
| 4: | 9.5 | ↙ |
| 5: | 7.9 | ↑ |
| 6: | 10.0 | ↑ |
| 7: | 8.4 | ↘ |
| 8: | 10.6x | → |
| 9: | 10.0 | ↗ |
| 10: | 10.1 | ↙ |
| Series | 90 (1x) | |
| | 365 (5x) | |

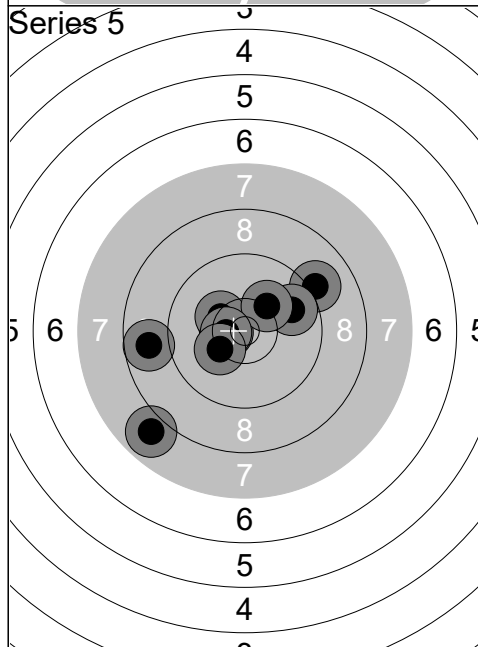

| | | |
|---------------|------------------|---|
| 1: | 7.9 | ↙ |
| 2: | 10.6x | ← |
| 3: | 9.1 | ↗ |
| 4: | 10.5x | ← |
| 5: | 8.8 | ← |
| 6: | 10.3 | ↙ |
| 7: | 9.8 | ↗ |
| 8: | 10.2 | ↗ |
| 9: | 10.5x | ← |
| 10: | 10.3 | ↙ |
| Series | 93 (3x) | |
| | 458 (8x) | |

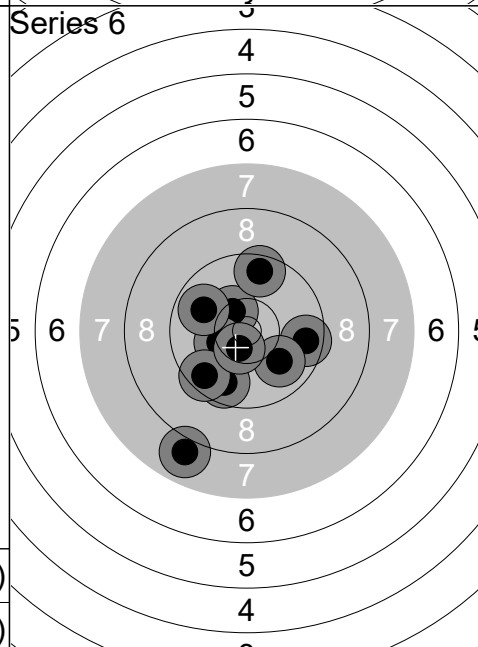

| | | |
|---------------|-------------------|---|
| 1: | 9.6 | → |
| 2: | 10.4x | ↖ |
| 3: | 10.3 | ← |
| 4: | 10.0 | ↘ |
| 5: | 9.7 | ↓ |
| 6: | 9.6 | ↑ |
| 7: | 9.6 | ↙ |
| 8: | 7.9 | ↓ |
| 9: | 9.9 | ↖ |
| 10: | 10.5x | ↓ |
| Series | 92 (2x) | |
| | 550 (10x) | |

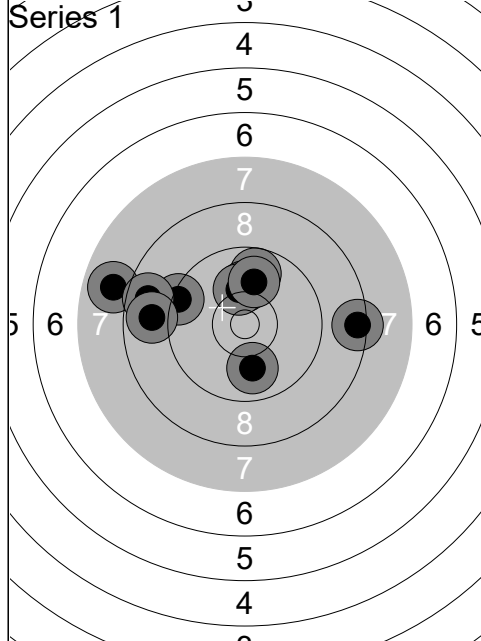

| | | |
|---------------|-----------------|---|
| 1: | 9.4 | ← |
| 2: | 7.9 | ← |
| 3: | 8.7 | ← |
| 4: | 9.8 | ↑ |
| 5: | 10.1 | ↑ |
| 6: | 10.0 | ↓ |
| 7: | 10.2 | ↑ |
| 8: | 8.9 | ← |
| 9: | 8.4 | → |
| 10: | 10.0 | ↑ |
| Series | 89 (0x) | |
| | 89 (0x) | |

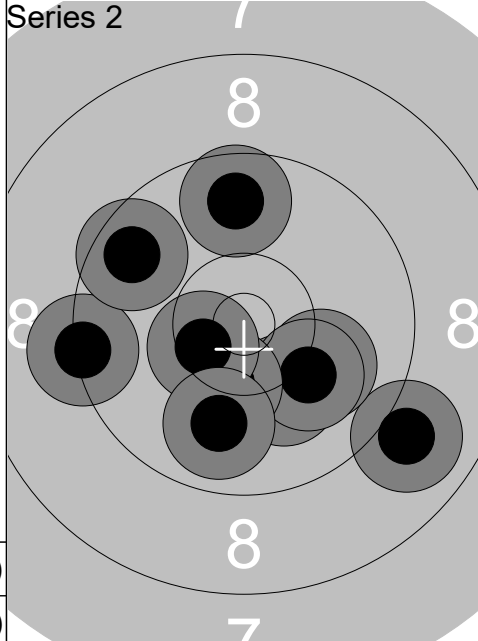

| | | |
|---------------|------------------|---|
| 1: | 9.0 | ↘ |
| 2: | 10.1 | ↗ |
| 3: | 10.2 | ↘ |
| 4: | 9.3 | ← |
| 5: | 10.1 | ↘ |
| 6: | 10.3 | ↓ |
| 7: | 10.5x | ↙ |
| 8: | 9.9 | ↓ |
| 9: | 9.7 | ↑ |
| 10: | 9.6 | ↖ |
| Series | 95 (1x) | |
| | 184 (1x) | |

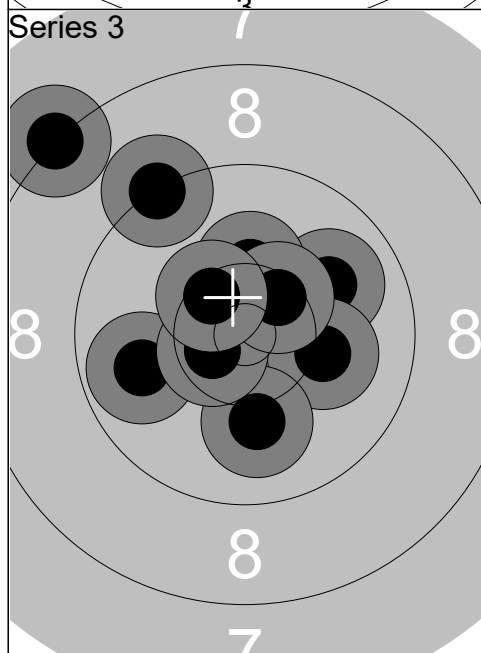

| | | |
|---------------|------------------|---|
| 1: | 9.9 | ← |
| 2: | 10.0 | ↗ |
| 3: | 10.1 | → |
| 4: | 10.1 | ↓ |
| 5: | 9.2 | ↗ |
| 6: | 10.3 | ↑ |
| 7: | 10.6x | ↙ |
| 8: | 10.4x | ↗ |
| 9: | 10.4x | ↖ |
| 10: | 8.2 | ↖ |
| Series | 96 (3x) | |
| | 280 (4x) | |

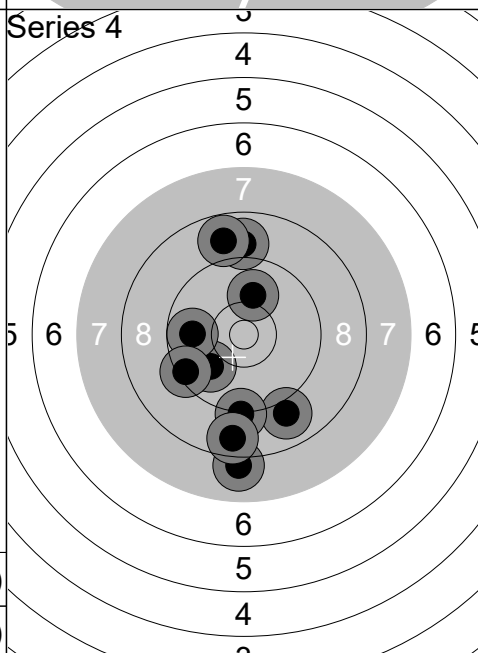

| | | |
|---------------|------------------|---|
| 1: | 8.9 | ↑ |
| 2: | 10.1 | ↑ |
| 3: | 8.8 | ↑ |
| 4: | 9.9 | ↖ |
| 5: | 9.8 | ← |
| 6: | 9.0 | ↓ |
| 7: | 9.2 | ↓ |
| 8: | 8.0 | ↓ |
| 9: | 9.4 | ↖ |
| 10: | 8.6 | ↓ |
| Series | 87 (0x) | |
| | 367 (4x) | |

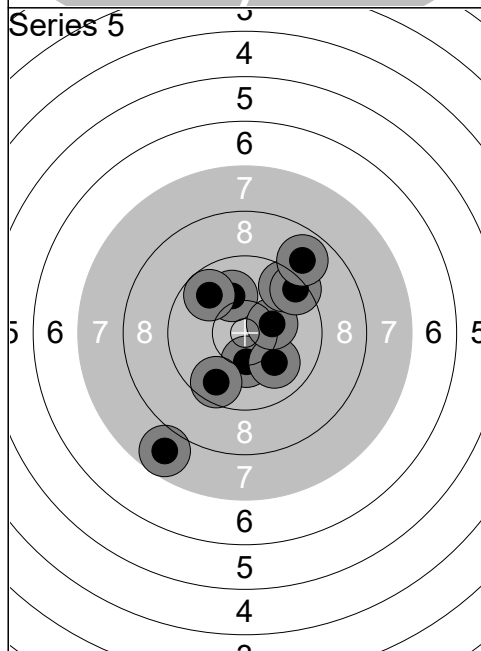

| | | |
|---------------|------------------|---|
| 1: | 10.3 | ↓ |
| 2: | 10.1 | ↑ |
| 3: | 10.0 | ↘ |
| 4: | 10.3 | → |
| 5: | 7.8 | ↘ |
| 6: | 9.6 | ↗ |
| 7: | 9.5 | ↗ |
| 8: | 9.7 | ↘ |
| 9: | 9.8 | ↖ |
| 10: | 8.9 | ↗ |
| Series | 91 (0x) | |
| | 458 (4x) | |

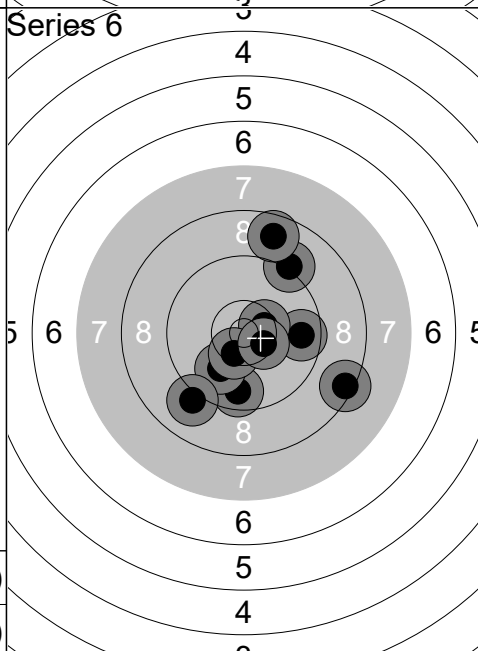

| | | |
|---------------|------------------|---|
| 1: | 9.2 | ↗ |
| 2: | 9.7 | ↓ |
| 3: | 10.0 | ↘ |
| 4: | 8.4 | ↘ |
| 5: | 9.7 | → |
| 6: | 10.5x | → |
| 7: | 10.4x | ↘ |
| 8: | 8.7 | ↑ |
| 9: | 9.1 | ↘ |
| 10: | 10.5x | ↘ |
| Series | 92 (3x) | |
| | 550 (7x) | |