

1:	9.3	↙
2:	8.7	←
3:	7.9	↗
4:	10.7x	↓
5:	7.7	↓
6:	6.4	↗
7:	8.9	↗
8:	10.0	←
9:	9.2	↗
10:	9.8	↗

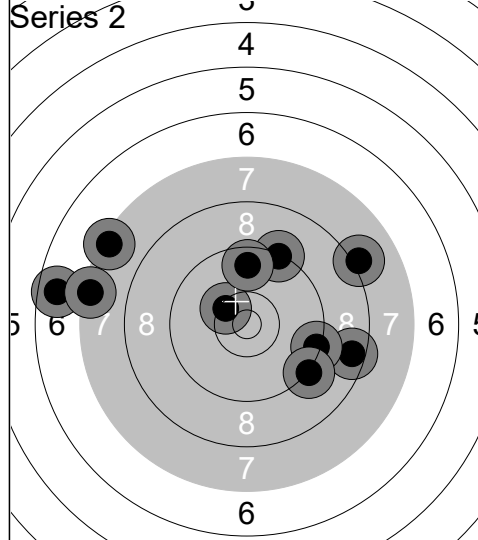

1:	9.3	↗
2:	8.5	⇒
3:	8.1	↗
4:	7.4	↙
5:	9.3	⇒
6:	9.2	↓
7:	10.4x	↙
8:	9.6	↑
9:	6.7	←
10:	7.4	←

Series	83 ( 1x)
Series	83 ( 1x)

Series	82 ( 1x)
Series	165 ( 2x)

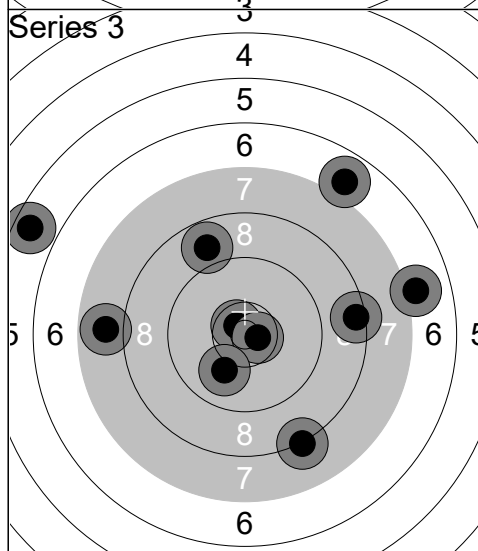

1:	6.9	↗
2:	10.7x	↙
3:	8.8	↑
4:	8.2	↓
5:	5.6	↙
6:	10.7x	⇒
7:	7.8	←
8:	8.4	⇒
9:	10.0	↓
10:	7.0	⇒

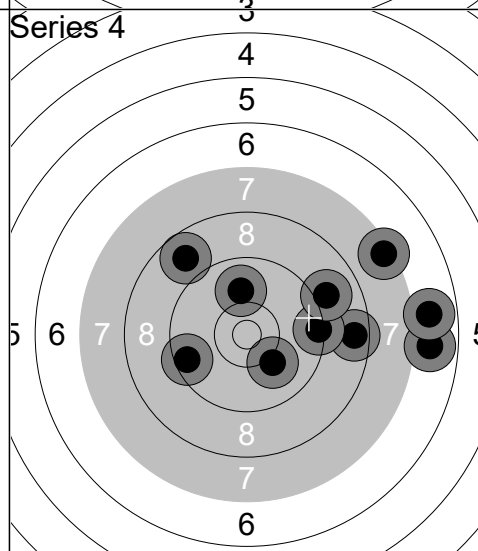

1:	8.6	⇒
2:	8.8	↗
3:	6.9	⇒
4:	10.0	↑
5:	10.1	↓
6:	9.3	⇒
7:	9.0	↗
8:	7.4	↗
9:	6.9	⇒
10:	9.5	←

Series	79 ( 2x)
Series	244 ( 4x)

Series	82 ( 0x)
Series	326 ( 4x)

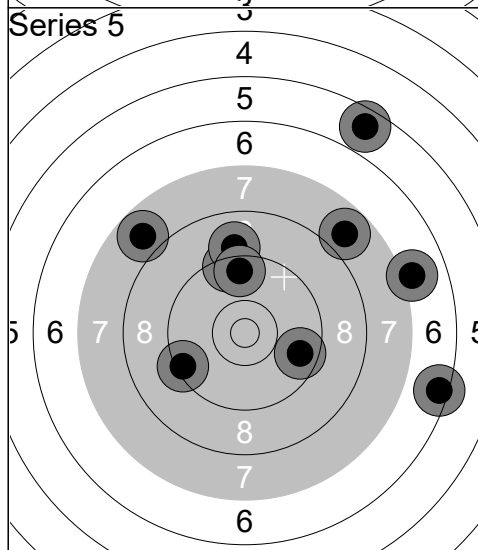

1:	6.4	⇒
2:	7.8	↗
3:	7.8	↙
4:	9.4	↑
5:	9.0	↑
6:	5.6	↗
7:	9.4	←
8:	7.0	⇒
9:	9.6	↑
10:	9.6	⇒

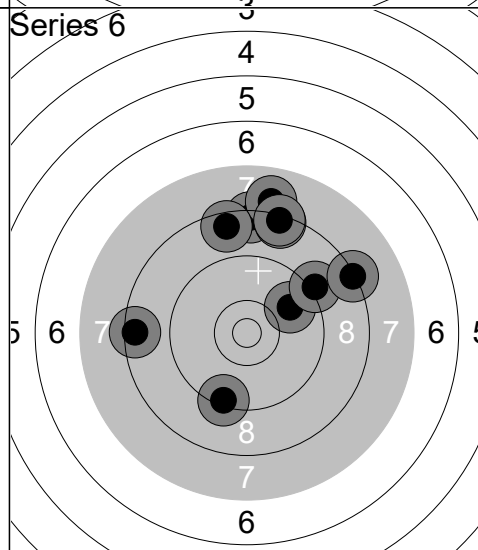

1:	9.8	↗
2:	9.1	↗
3:	8.4	↑
4:	8.5	←
5:	8.3	↗
6:	9.4	↓
7:	8.0	↑
8:	8.4	↑
9:	8.5	↑
10:	8.3	↑

Series	77 ( 0x)
Series	403 ( 4x)

Series	83 ( 0x)
Series	486 ( 4x)

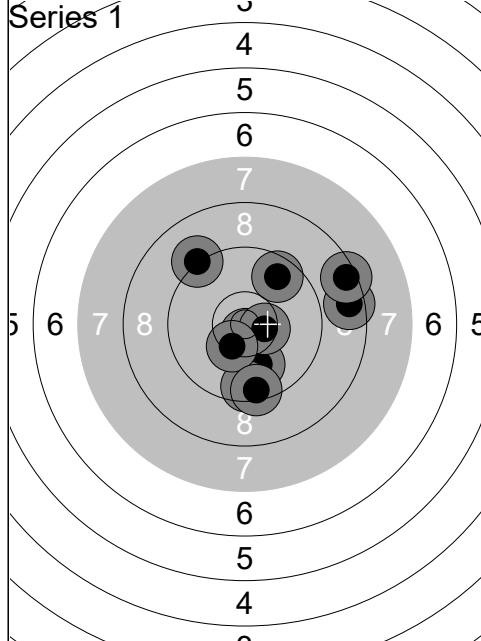

1:	10.7x ↓
2:	10.0 ↓
3:	10.5x →
4:	9.6 ↓
5:	8.6 →
6:	8.5 →
7:	9.2 ↖
8:	10.4x ↓
9:	9.7 ↗
10:	9.5 ↓
<b>Series</b>	<b>92 ( 3x)</b>
	<b>92 ( 3x)</b>

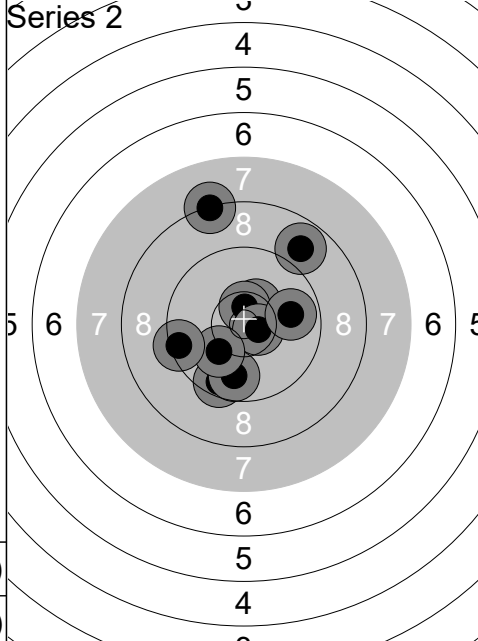

1:	9.6 ↙
2:	10.4x ↗
3:	10.6x ↑
4:	10.6x →
5:	9.8 ↓
6:	10.1 ↙
7:	9.9 →
8:	8.8 ↗
9:	8.3 ↑
10:	9.4 ←
<b>Series</b>	<b>92 ( 3x)</b>
	<b>184 ( 6x)</b>

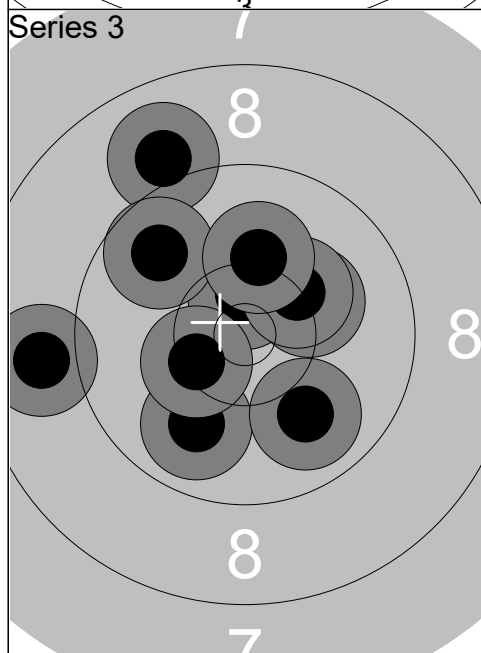

1:	10.5x ↑
2:	9.9 ↓
3:	8.9 ←
4:	10.4x ↙
5:	9.9 ↓
6:	9.0 ↑
7:	10.2 →
8:	10.3 ↗
9:	9.8 ↖
10:	10.2 ↑
<b>Series</b>	<b>94 ( 2x)</b>
	<b>278 ( 8x)</b>

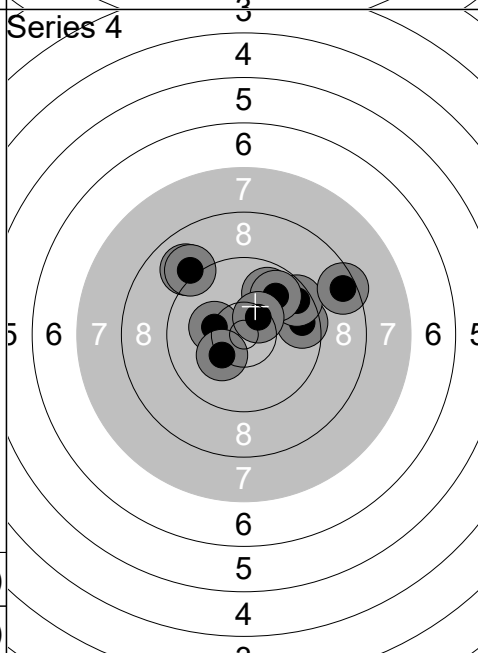

1:	9.6 →
2:	9.5 ↗
3:	9.9 ↗
4:	10.3 ←
5:	9.8 ↗
6:	9.0 ↖
7:	10.3 ↙
8:	8.5 →
9:	10.4x ↗
10:	9.1 ↖
<b>Series</b>	<b>92 ( 1x)</b>
	<b>370 ( 9x)</b>

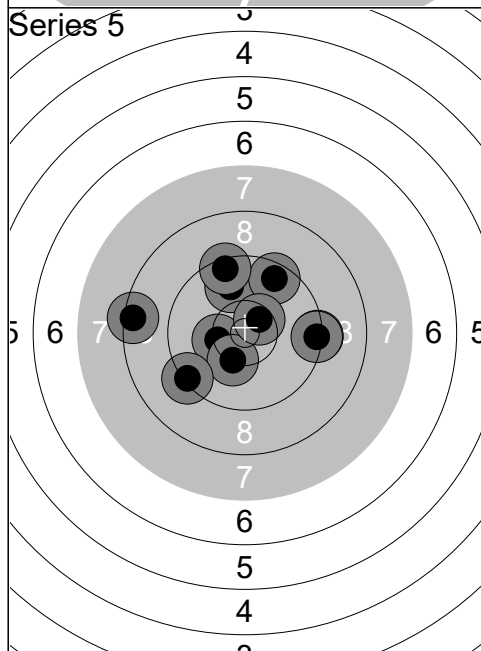

1:	9.9 ↑
2:	9.6 ↗
3:	10.3 ←
4:	10.3 ↓
5:	8.4 ←
6:	9.3 →
7:	9.4 →
8:	9.5 ↑
9:	10.5x ↗
10:	9.3 ↙
<b>Series</b>	<b>92 ( 1x)</b>
	<b>462 ( 10x)</b>

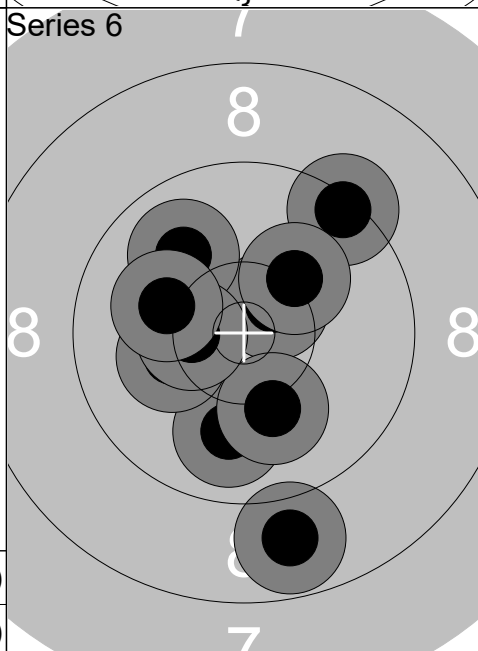

1:	9.4 ↗
2:	9.9 ↓
3:	10.5x ↗
4:	10.1 ↓
5:	10.0 ↖
6:	10.2 ↗
7:	10.2 ←
8:	10.4x ↙
9:	10.1 ←
10:	8.8 ↓
<b>Series</b>	<b>96 ( 2x)</b>
	<b>558 ( 12x)</b>

Relay	Lane	Line Nielsen			
4	21				
Qual Day 3		DEN			
11.02.2026		Denmark Open Air 2026			
Series 1		Denmark Open Air 2026			
	1: 10.0 ↘		1: 9.6 →		
	2: 7.7 ↙		2: 8.8 ↓		
	3: 9.2 ↓		3: 9.4 ↙		
	4: 7.7 ↓		4: 9.5 ↘		
	5: 7.3 ↘		5: 10.0 ↓		
	6: 9.9 ↘		6: 10.4 ↑		
	7: 9.3 ↗		7: 9.5 ↑		
	8: 10.2 ↓		8: 9.6 ↘		
	9: 7.9 ↙		9: 10.1 ↖		
	10: 9.6 ↙		10: 8.8 ↗		
Series 84 (0x)	Series 91 (0x)				
84 (0x)	175 (0x)				
				1: 9.1 ↑	1: 9.0 ↓
				2: 9.7 ↙	2: 9.2 ↘
				3: 9.3 ↗	3: 8.6 ↓
				4: 8.2 →	4: 9.5 ↓
				5: 7.3 ↙	5: 10.4 ↗
				6: 9.8 ↓	6: 9.7 ↗
				7: 9.3 ↓	7: 9.4 ↓
				8: 9.7 ↗	8: 8.6 →
				9: 8.4 ↘	9: 8.6 ↑
10: 9.1 ↗	10: 8.9 ↑				
Series 86 (0x)	Series 87 (0x)				
261 (0x)	348 (0x)				
				1: 9.2 ↓	1: 8.8 →
				2: 8.8 →	2: 5.5 ↙
				3: 7.6 ↓	3: 9.1 ↑
				4: 10.5x ↓	4: 9.7 →
				5: 9.4 ↗	5: 10.2 ↓
				6: 10.3 ↓	6: 9.0 ↘
				7: 9.7 ↓	7: 8.4 ↙
				8: 10.1 ↙	8: 9.9 ↗
				9: 9.8 →	9: 9.8 ↑
10: 9.1 ↖	10: 8.3 ↙				
Series 90 (1x)	Series 84 (0x)				
438 (1x)	522 (1x)				

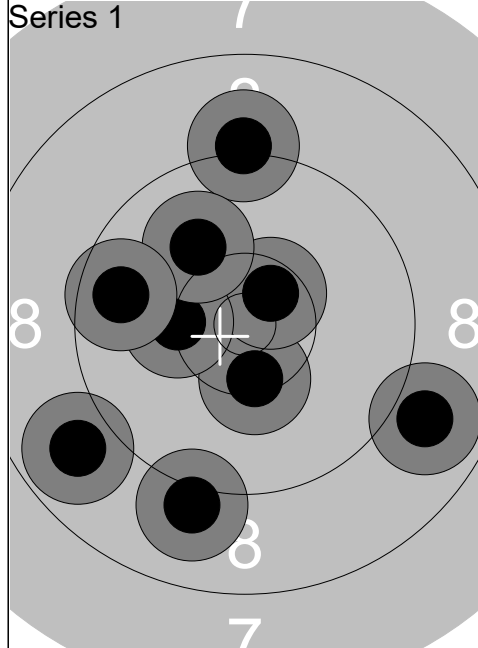

1:	10.9x ↖
2:	10.4x ↓
3:	8.8 ←
4:	9.1 ↓
5:	8.9 →
6:	10.5x ↗
7:	10.3 ←
8:	9.2 ↑
9:	10.0 ↗
10:	9.7 ←
Series	93 ( 3x)
	93 ( 3x)

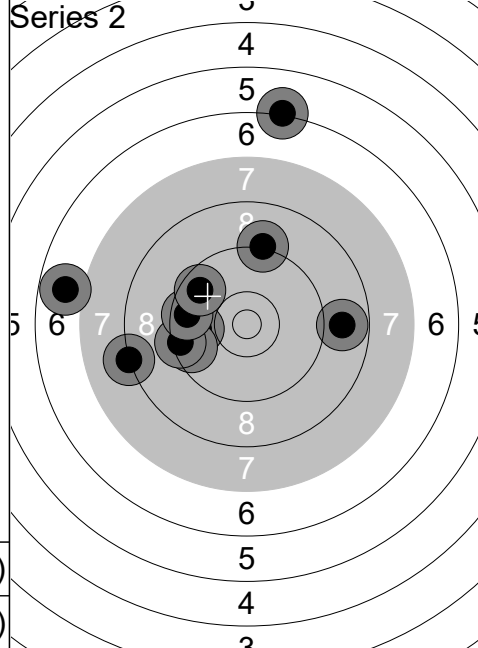

1:	9.9 ←
2:	9.2 ↑
3:	9.6 ←
4:	8.8 →
5:	9.4 ←
6:	6.8 ←
7:	6.2 ↑
8:	9.6 ←
9:	8.2 ←
10:	9.7 ↖
Series	82 ( 0x)
	175 ( 3x)

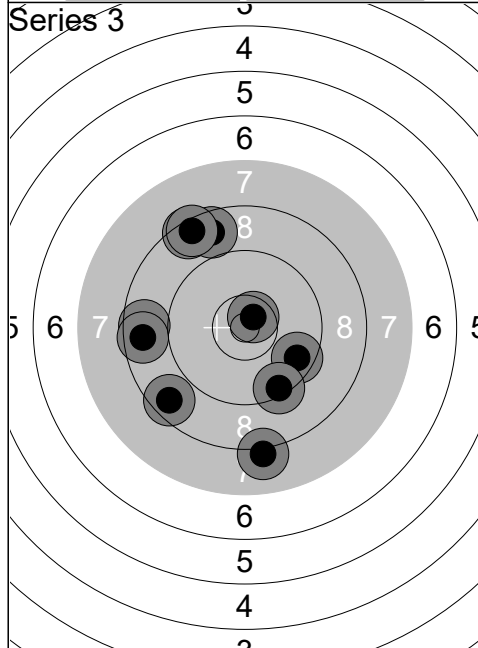

1:	8.6 ←
2:	8.5 ↗
3:	8.7 ↗
4:	8.5 ↗
5:	8.1 ↓
6:	9.6 →
7:	8.7 ←
8:	10.6x ↗
9:	8.7 ←
10:	9.4 ↓
Series	84 ( 1x)
	259 ( 4x)

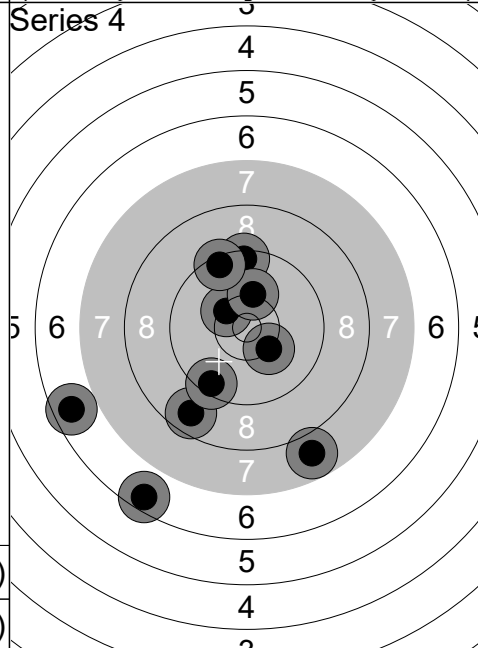

1:	6.6 ←
2:	7.8 ↓
3:	8.7 ↓
4:	10.4x ↖
5:	9.4 ↑
6:	9.5 ↓
7:	10.2 ↑
8:	9.4 ↗
9:	6.5 ↓
10:	10.3 ↓
Series	84 ( 1x)
	343 ( 5x)

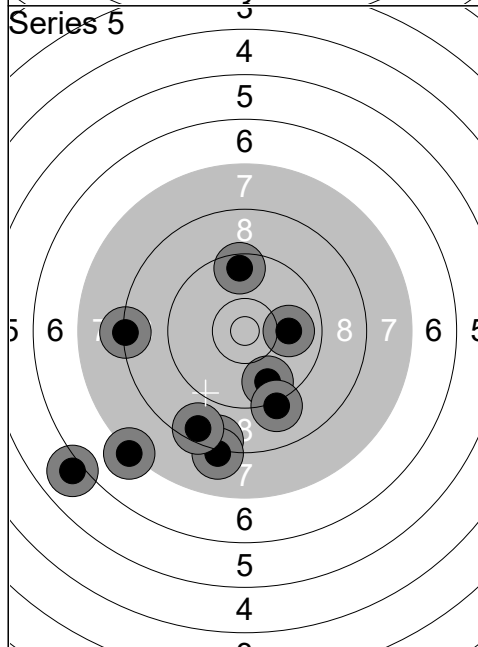

1:	8.4 ↓
2:	9.5 ↑
3:	7.2 ↖
4:	9.7 ↓
5:	6.0 ←
6:	8.2 ↓
7:	10.0 →
8:	8.5 ↓
9:	8.3 ←
10:	9.1 ↓
Series	82 ( 0x)
	425 ( 5x)

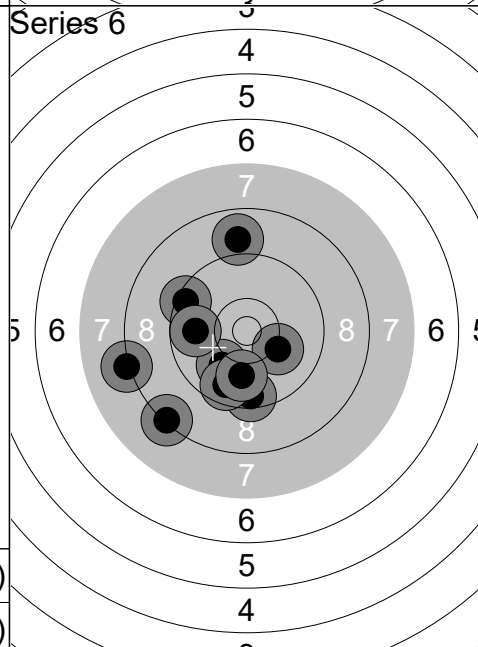

1:	9.5 ↓
2:	8.3 ↖
3:	8.9 ↑
4:	10.0 ↖
5:	9.4 ↖
6:	9.7 ↓
7:	10.2 →
8:	9.8 ←
9:	10.0 ↓
10:	8.2 ←
Series	90 ( 0x)
	515 ( 5x)

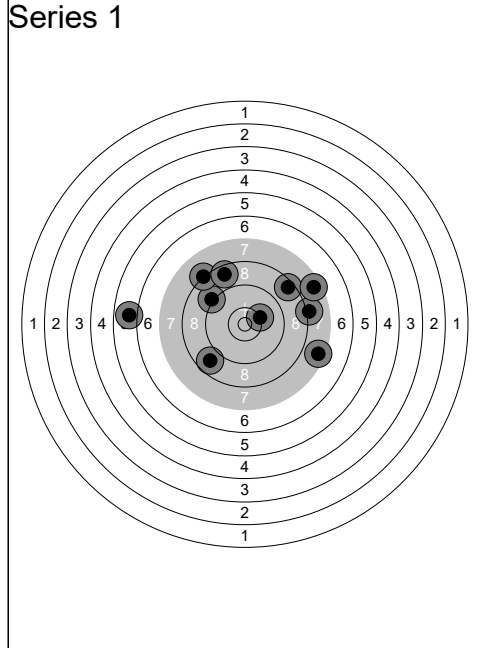

1: 9.1 ↖
2: 5.9 ←
3: 8.2 ↗
4: 8.5 ↗
5: 10.2 ↗
6: 8.1 →
7: 8.7 ↙
8: 8.6 ↑
9: 7.5 →
10: 7.5 ↗
<b>Series 78 (0x)</b>
<b>78 (0x)</b>

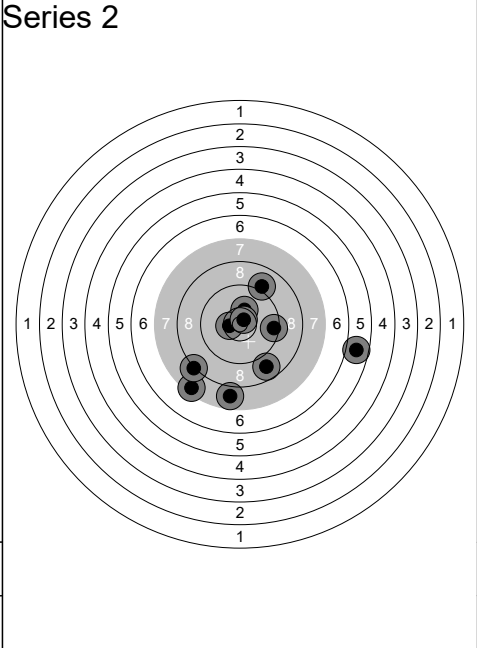

1: 10.5x ←
2: 9.1 ↗
3: 5.8 →
4: 7.5 ↙
5: 7.8 ↓
6: 10.3 ↗
7: 8.2 ↙
8: 9.5 →
9: 10.7x ↗
10: 8.8 ↘
<b>Series 83 (2x)</b>
<b>161 (2x)</b>

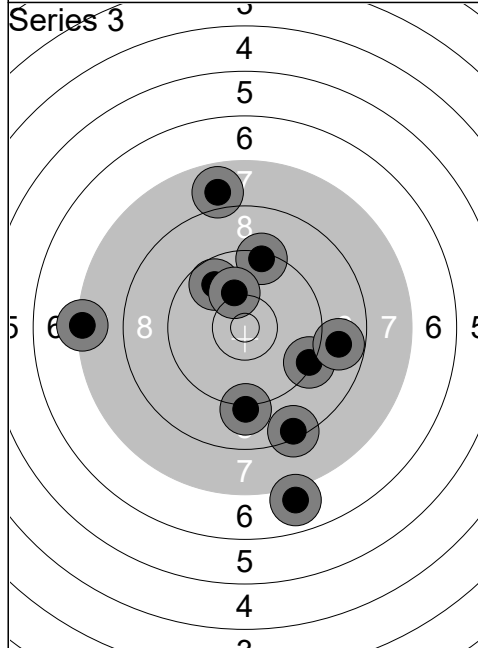

1: 7.9 ↑
2: 7.0 ↓
3: 9.3 →
4: 7.3 ←
5: 8.8 →
6: 9.1 ↓
7: 8.4 ↓
8: 9.4 ↑
9: 9.8 ↗
10: 10.1 ↑
<b>Series 83 (0x)</b>
<b>244 (2x)</b>

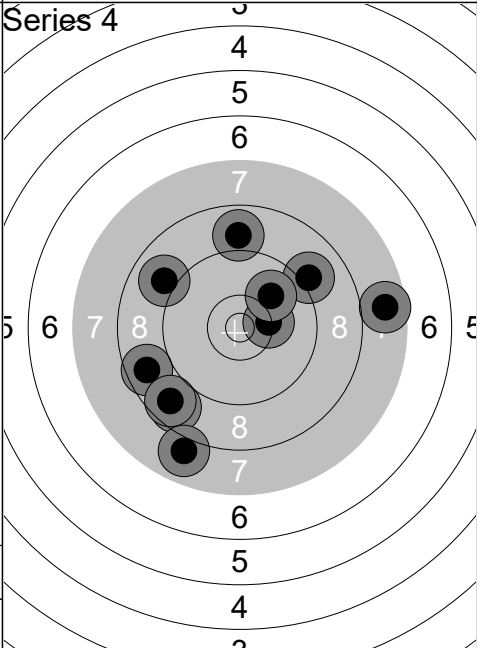

1: 9.1 ↗
2: 9.0 ↖
3: 8.9 ↑
4: 8.7 ←
5: 8.7 ↙
6: 10.3 →
7: 8.7 ↙
8: 10.0 ↗
9: 7.7 →
10: 7.9 ↓
<b>Series 84 (0x)</b>
<b>328 (2x)</b>

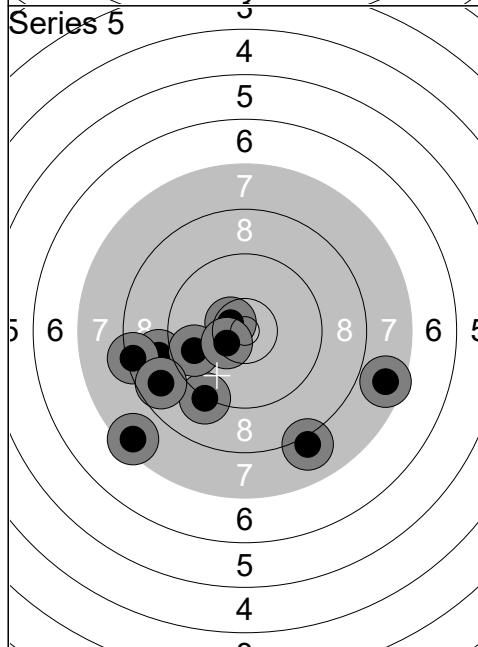

1: 9.2 ↓
2: 10.6x ↖
3: 7.6 →
4: 8.1 ↓
5: 9.0 ←
6: 9.7 ←
7: 7.5 ↙
8: 10.5x ←
9: 8.4 ←
10: 8.7 ↙
<b>Series 85 (2x)</b>
<b>413 (4x)</b>

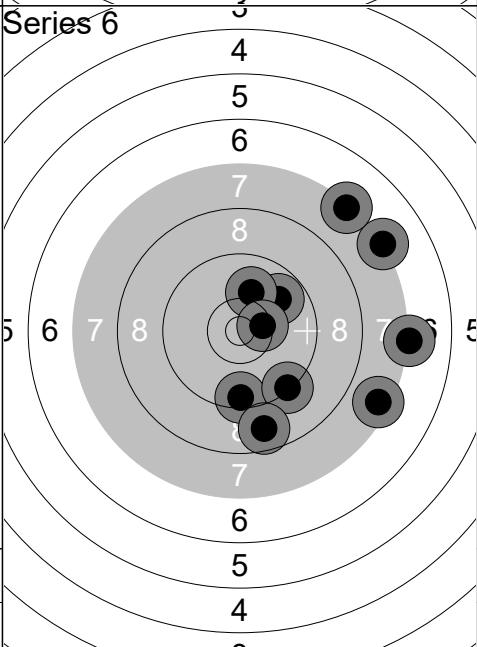

1: 7.2 ↗
2: 7.5 →
3: 7.2 →
4: 9.5 ↓
5: 7.3 ↗
6: 9.8 ↗
7: 9.3 ↙
8: 8.7 ↓
9: 10.1 ↑
10: 10.4x →
<b>Series 83 (1x)</b>
<b>496 (5x)</b>

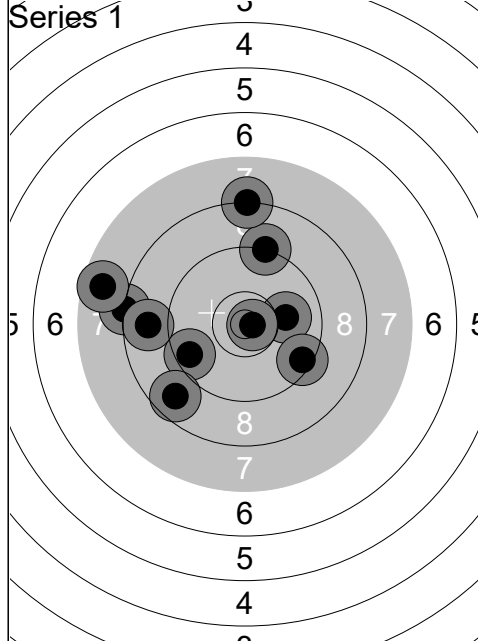

1: 8.3 ←
2: 7.7 ←
3: 9.5 ←
4: 9.2 ↑
5: 8.7 ↓
6: 10.0 →
7: 8.2 ↑
8: 10.8x →
9: 9.4 ↓
10: 8.8 ←
<b>Series 86 ( 1x)</b>
<b>86 ( 1x)</b>

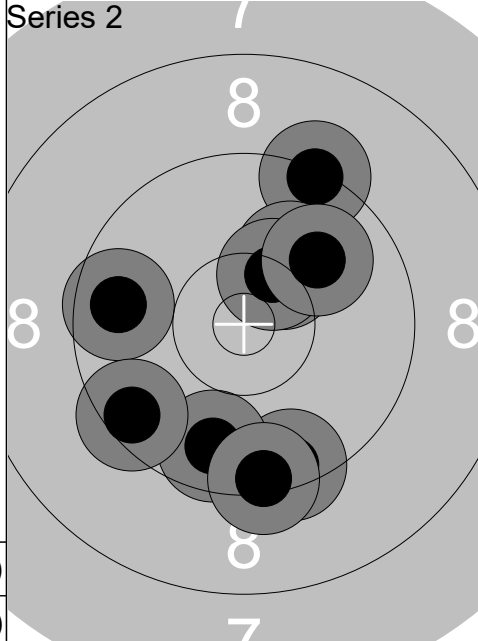

1: 9.7 ←
2: 9.5 ↓
3: 9.3 ↑
4: 10.3 ↗
5: 10.1 ↗
6: 9.7 ↓
7: 9.4 ↓
8: 10.4x ↗
9: 9.5 ←
10: 10.0 ↗
<b>Series 94 ( 1x)</b>
<b>180 ( 2x)</b>

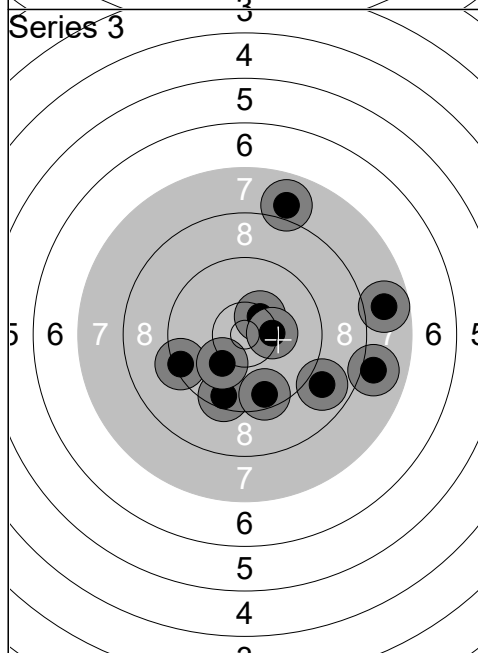

1: 9.5 ↓
2: 9.4 ←
3: 8.0 →
4: 7.8 →
5: 10.4x ↗
6: 7.9 ↑
7: 8.9 ↓
8: 9.6 ↓
9: 10.1 ↓
10: 10.3 →
<b>Series 87 ( 1x)</b>
<b>267 ( 3x)</b>

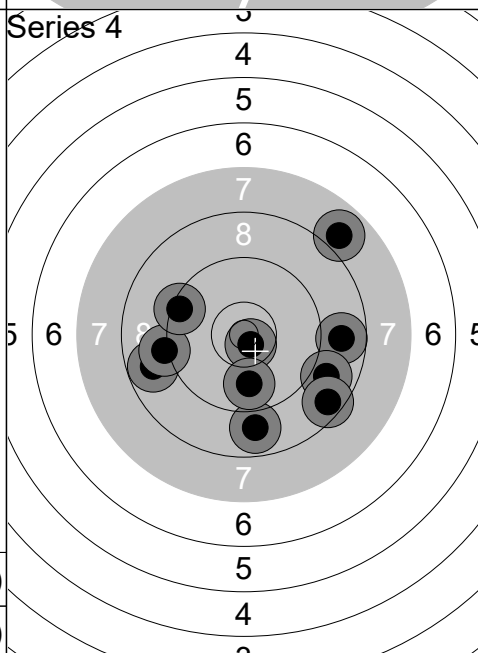

1: 8.8 →
2: 8.9 ↓
3: 10.7x ↓
4: 9.9 ↓
5: 8.8 ←
6: 9.1 ←
7: 9.4 ←
8: 8.9 ↓
9: 8.6 ↓
10: 7.9 ↗
<b>Series 84 ( 1x)</b>
<b>351 ( 4x)</b>

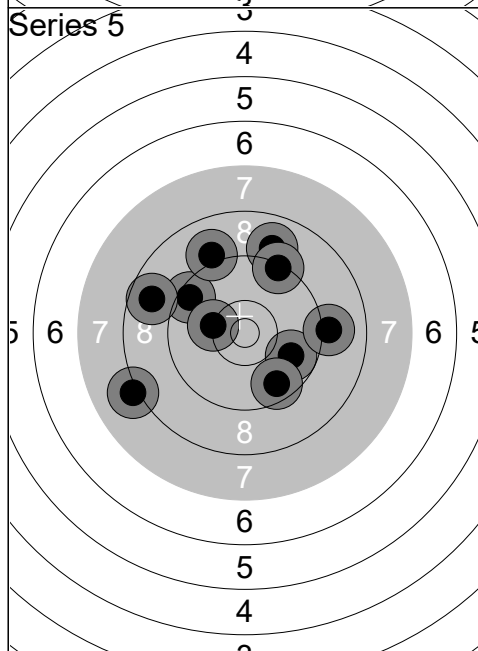

1: 9.5 ↖
2: 9.8 ↗
3: 9.1 →
4: 9.0 ↑
5: 9.6 ↓
6: 8.7 ←
7: 9.3 ↑
8: 10.2 ←
9: 9.1 ↑
10: 8.1 ←
<b>Series 89 ( 0x)</b>
<b>440 ( 4x)</b>

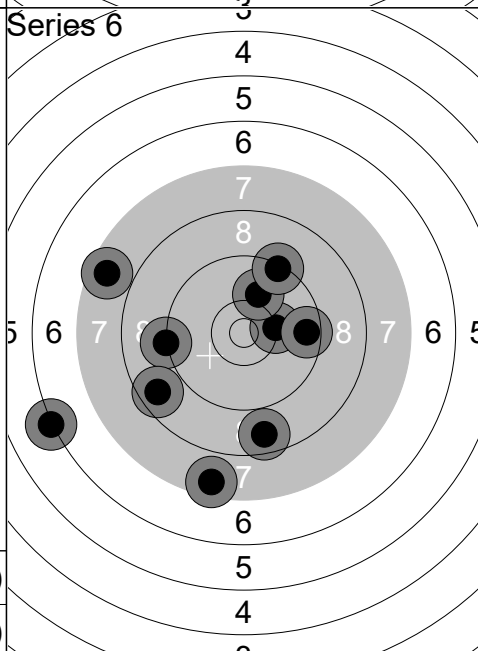

1: 10.2 →
2: 10.0 ↑
3: 9.5 →
4: 9.2 ←
5: 8.7 ↓
6: 7.6 ←
7: 7.6 ↓
8: 9.3 ↑
9: 8.6 ←
10: 6.2 ←
<b>Series 83 ( 0x)</b>
<b>523 ( 4x)</b>

Relay	Lane	Katja Winther		
4	25	DEN	Wp	P
Qual Day 3		Denmark Open Air 2026		Denmark Open Air 2026
11.02.2026				
Series 1		1: 10.5x ←	Series 2	1: 8.2 ↘
		2: 9.6 ↘		2: 9.9 →
		3: 9.4 →		3: 8.5 ↘
		4: 6.8 ↘		4: 9.3 ↘
		5: 9.1 →		5: 10.6x ↘
		6: 8.2 ↗		6: 8.9 ↘
		7: 8.9 ←		7: 8.7 ↘
		8: 8.1 ←		8: 9.8 ↘
		9: 9.9 ↖		9: 8.6 ↖
		10: 9.7 ↖		10: 8.1 ↖
		Series 85 ( 1x)		Series 85 ( 1x)
		85 ( 1x)		170 ( 2x)
Series 3		1: 8.7 ↘	Series 4	1: 10.5x ↘
		2: 6.4 →		2: 8.4 ←
		3: 9.8 ↘		3: 10.3 ↖
		4: 9.2 ↘		4: 10.6x ↗
		5: 10.1 ↘		5: 7.9 →
		6: 9.5 →		6: 8.6 →
		7: 9.9 ←		7: 6.8 ↖
		8: 8.7 ↗		8: 10.3 ↗
		9: 8.7 ↗		9: 9.0 ↗
		10: 10.3 ↗		10: 10.2 ↘
		Series 86 ( 0x)		Series 88 ( 2x)
		256 ( 2x)		344 ( 4x)
Series 5		1: 9.3 ←	Series 6	1: 9.5 ←
		2: 9.8 ↘		2: 10.5x ↖
		3: 9.4 ←		3: 8.7 ↗
		4: 9.2 ↖		4: 8.6 ←
		5: 9.2 ↘		5: 9.6 ←
		6: 9.4 ↖		6: 8.6 ↘
		7: 9.6 ↖		7: 9.3 ←
		8: 9.8 ↗		8: 10.0 ↘
		9: 10.2 ↖		9: 10.0 ↘
		10: 8.7 ↘		10: 9.4 ↘
		Series 90 ( 0x)		Series 90 ( 1x)
		434 ( 4x)		524 ( 5x)

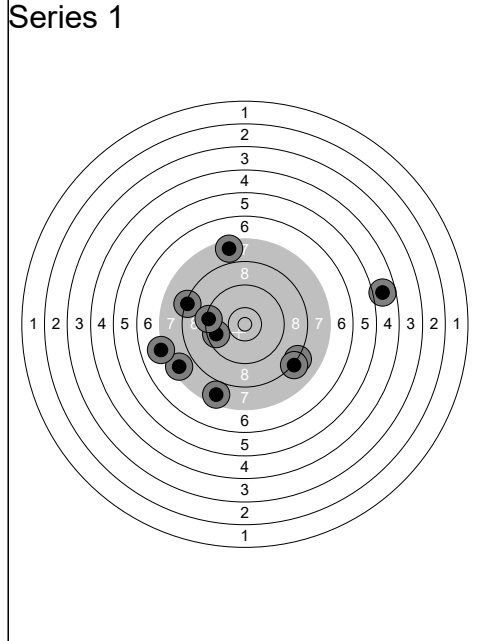

1: 9.6 ←
2: 4.8 →
3: 8.2 ↘
4: 7.6 ←
5: 7.6 ↑
6: 7.6 ↓
7: 8.3 ←
8: 8.2 ↘
9: 9.4 ←
10: 7.1 ←
<b>Series 74 ( 0x)</b>
<b>74 ( 0x)</b>

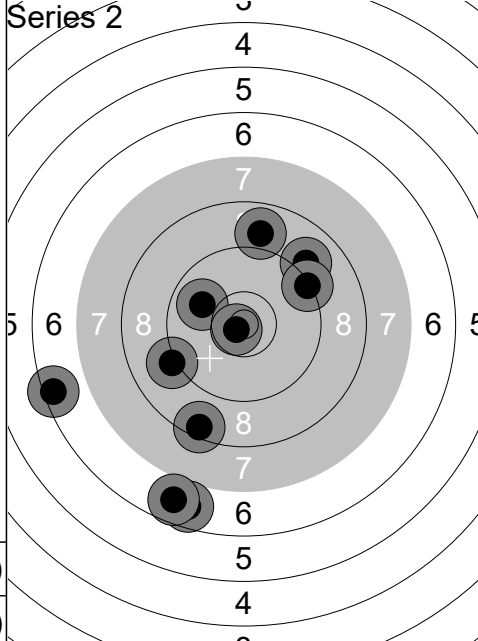

1: 6.5 ←
2: 8.5 ↓
3: 9.1 ←
4: 8.9 ↑
5: 9.9 ←
6: 6.7 ↓
7: 9.0 ↗
8: 6.7 ↓
9: 9.3 ↗
10: 10.7x ↙
<b>Series 80 ( 1x)</b>
<b>154 ( 1x)</b>

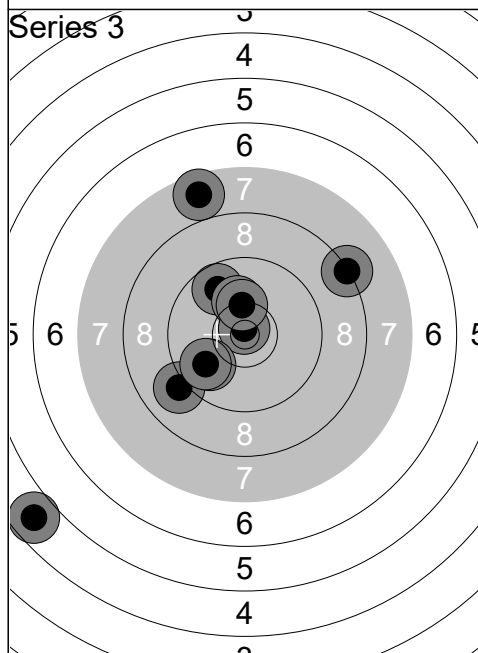

1: 9.1 ←
2: 9.8 ↗
3: 10.2 ↑
4: 4.7 ←
5: 7.7 ↑
6: 10.8x ↑
7: 9.9 ←
8: 10.3 ↑
9: 8.3 ↗
10: 9.9 ←
<b>Series 85 ( 1x)</b>
<b>239 ( 2x)</b>

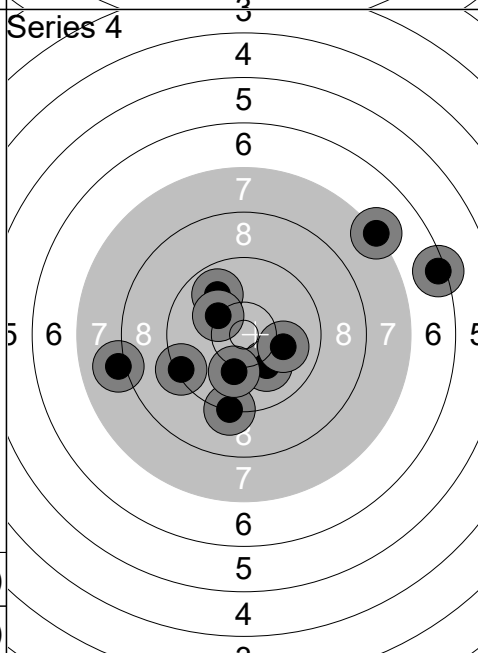

1: 9.9 ↖
2: 7.2 ↗
3: 8.1 ←
4: 10.1 ↓
5: 9.4 ←
6: 10.0 →
7: 10.2 ↖
8: 9.3 ↓
9: 6.4 →
10: 10.1 ↓
<b>Series 88 ( 0x)</b>
<b>327 ( 2x)</b>

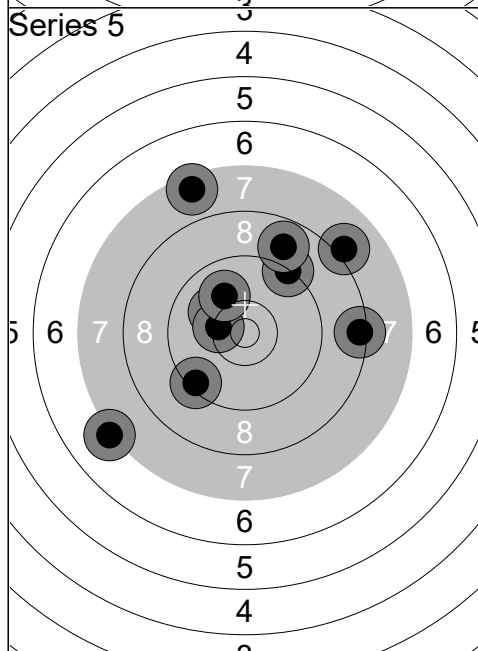

1: 9.3 ↗
2: 8.4 →
3: 10.1 ↖
4: 10.3 ←
5: 8.1 ↗
6: 8.8 ↑
7: 7.2 ←
8: 10.0 ↖
9: 7.5 ↑
10: 9.4 ↙
<b>Series 86 ( 0x)</b>
<b>413 ( 2x)</b>

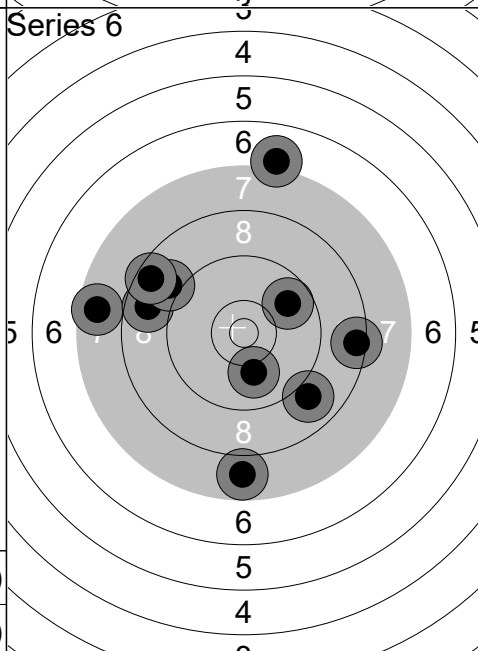

1: 7.8 ↓
2: 7.6 ←
3: 8.7 ←
4: 7.1 ↑
5: 10.0 ↓
6: 8.9 ↓
7: 9.0 ↖
8: 8.6 ↖
9: 8.4 →
10: 9.8 ↗
<b>Series 81 ( 0x)</b>
<b>494 ( 2x)</b>

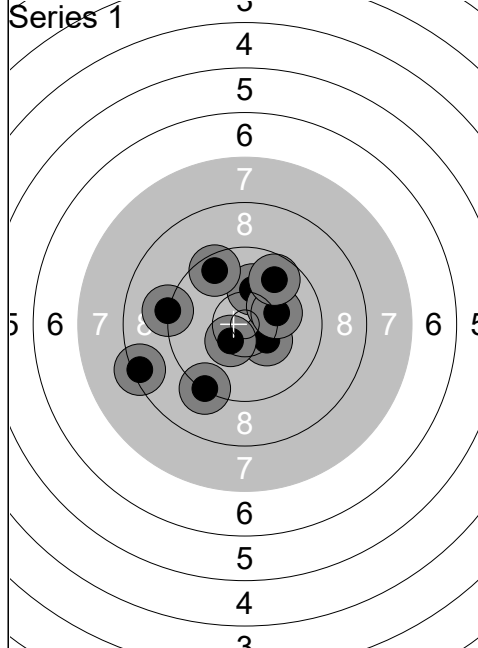

1:	10.2	↑
2:	10.4	↘
3:	10.2	↗
4:	9.2	←
5:	10.2	→
6:	9.8	↗
7:	9.6	↑
8:	9.3	↓
9:	8.4	←
10:	10.5x	↙
<b>Series</b>	<b>94 ( 1x)</b>	
	<b>94 ( 1x)</b>	

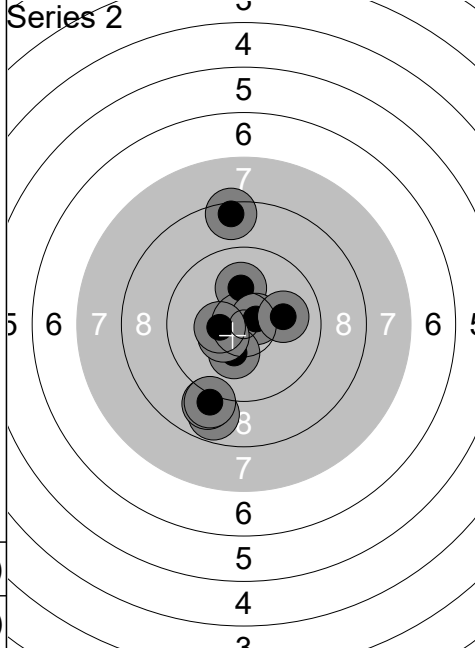

1:	10.1	↑
2:	10.7x	→
3:	10.1	→
4:	10.3	↓
5:	8.8	↓
6:	9.0	↓
7:	9.1	↓
8:	8.5	↑
9:	10.4x	↙
10:	10.4x	←
<b>Series</b>	<b>94 ( 3x)</b>	
	<b>188 ( 4x)</b>	

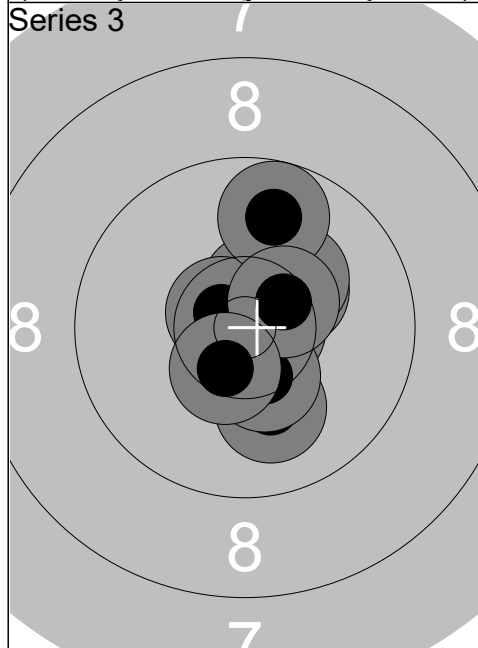

1:	10.7x	→
2:	10.3	↗
3:	10.1	↓
4:	10.5x	↑
5:	10.4x	↓
6:	10.3	↗
7:	10.7x	↙
8:	9.8	↑
9:	10.5x	↗
10:	10.5x	↓
<b>Series</b>	<b>99 ( 6x)</b>	
	<b>287 (10x)</b>	

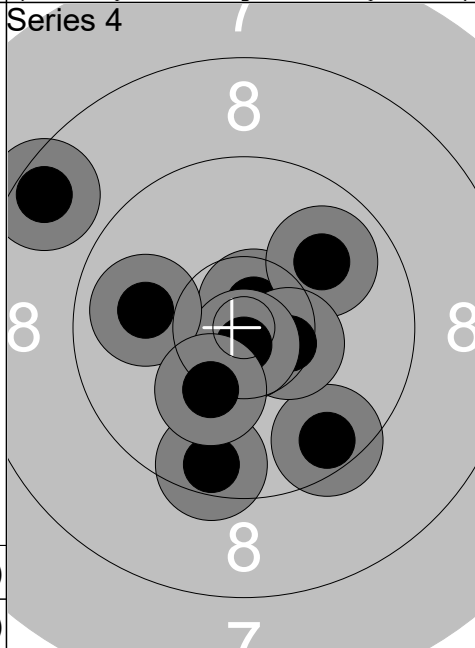

1:	10.7x	↙
2:	9.5	↓
3:	10.7x	↑
4:	9.9	↗
5:	10.5x	→
6:	10.8x	↓
7:	9.5	↓
8:	10.0	←
9:	10.2	↓
10:	8.5	↙
<b>Series</b>	<b>95 ( 4x)</b>	
	<b>382 (14x)</b>	

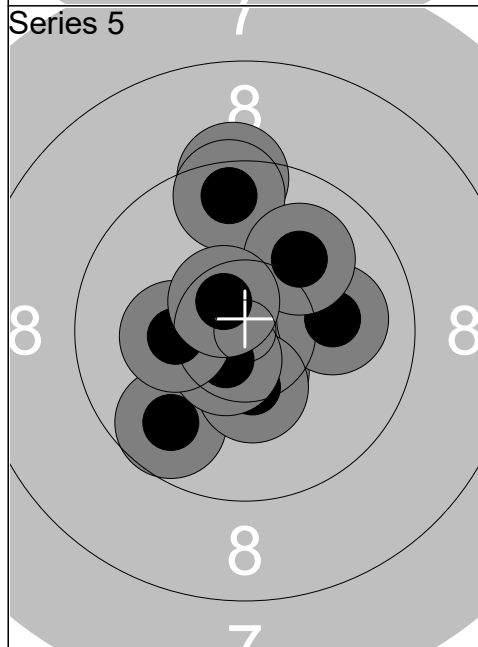

1:	10.5x	↓
2:	10.1	→
3:	9.8	↓
4:	10.4x	↓
5:	9.4	↑
6:	9.6	↑
7:	10.0	↗
8:	10.6x	↙
9:	10.2	←
10:	10.6x	↖
<b>Series</b>	<b>97 ( 4x)</b>	
	<b>479 (18x)</b>	

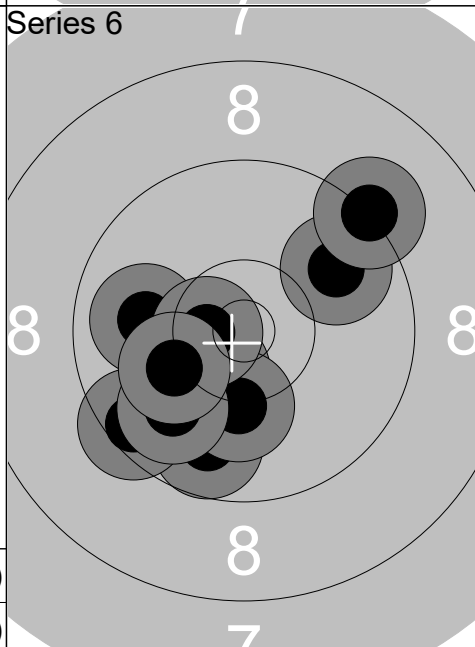

1:	10.4x	↙
2:	9.8	↓
3:	9.8	↗
4:	9.2	↗
5:	10.2	↓
6:	10.0	←
7:	9.5	↙
8:	10.6x	←
9:	9.9	↙
10:	10.2	←
<b>Series</b>	<b>95 ( 2x)</b>	
	<b>574 (20x)</b>	

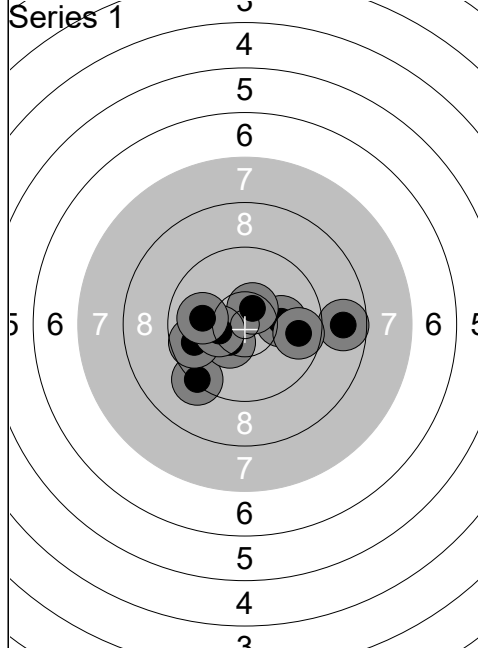

1:	10.1	←
2:	9.3	↙
3:	8.8	→
4:	10.1	→
5:	9.7	→
6:	10.4x	↙
7:	10.6x	↗
8:	9.8	←
9:	10.4	←
10:	10.0	←
<b>Series</b>	<b>95 ( 2x)</b>	
	<b>95 ( 2x)</b>	

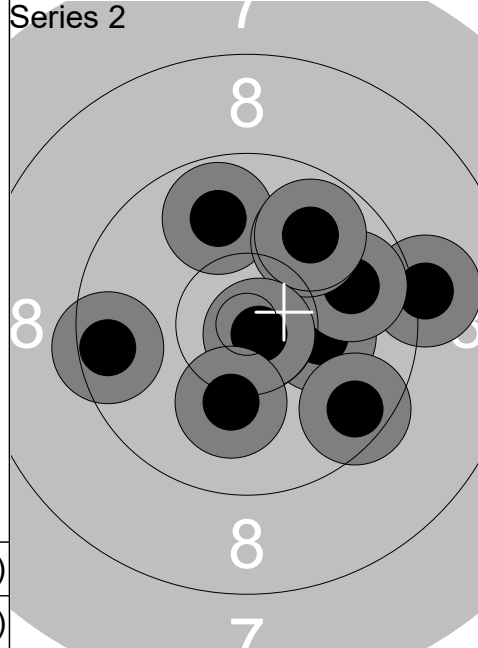

1:	10.2	→
2:	9.1	→
3:	9.8	↑
4:	9.8	→
5:	9.6	↘
6:	9.9	↗
7:	9.5	←
8:	9.8	↗
9:	10.8x	↘
10:	10.1	↓
<b>Series</b>	<b>93 ( 1x)</b>	
	<b>188 ( 3x)</b>	

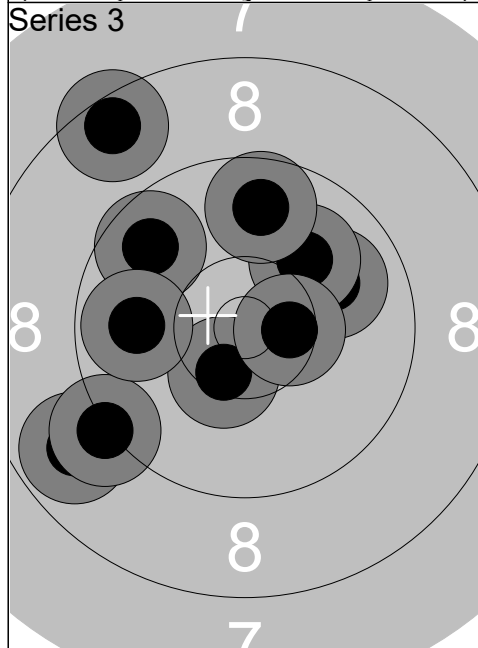

1:	8.5	↖
2:	10.0	↗
3:	10.4x	↘
4:	10.0	↗
5:	9.7	↑
6:	9.7	↖
7:	8.9	←
8:	9.2	←
9:	9.9	←
10:	10.5x	→
<b>Series</b>	<b>92 ( 2x)</b>	
	<b>280 ( 5x)</b>	

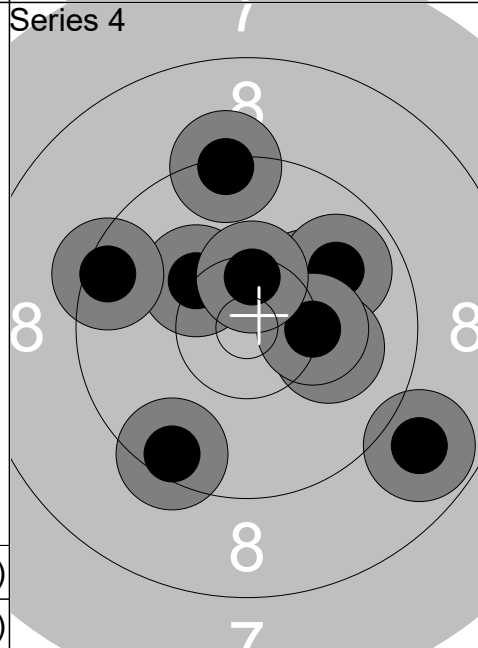

1:	9.3	↑
2:	10.3	↖
3:	10.2	↗
4:	9.4	←
5:	9.9	↗
6:	8.8	↘
7:	10.1	→
8:	10.3	→
9:	9.5	↘
10:	10.4x	↑
<b>Series</b>	<b>94 ( 1x)</b>	
	<b>374 ( 6x)</b>	

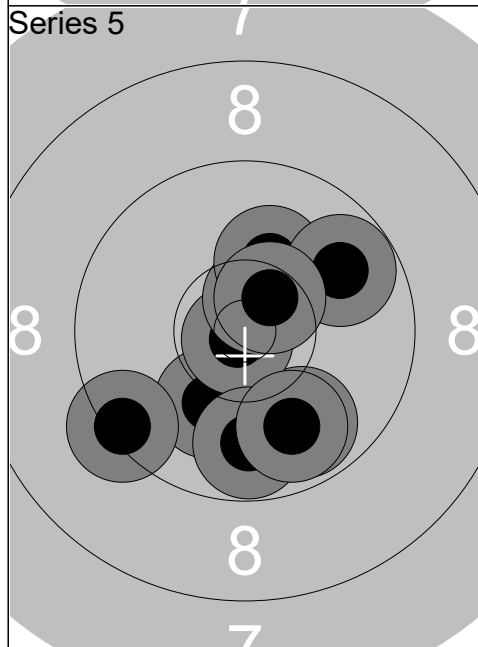

1:	10.2	↓
2:	9.9	↘
3:	10.8x	↙
4:	10.6x	↗
5:	9.8	↓
6:	10.2	↗
7:	9.8	↗
8:	10.5x	↗
9:	9.4	←
10:	9.9	↓
<b>Series</b>	<b>95 ( 3x)</b>	
	<b>469 ( 9x)</b>	

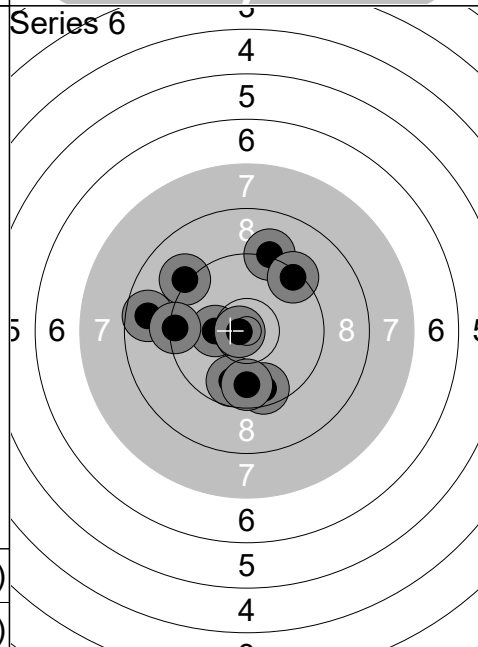

1:	9.8	↓
2:	10.3	←
3:	9.2	↗
4:	9.2	↖
5:	8.7	←
6:	9.3	←
7:	9.6	↓
8:	9.4	↗
9:	9.8	↓
10:	10.8x	←
<b>Series</b>	<b>91 ( 1x)</b>	
	<b>560 ( 10x)</b>	

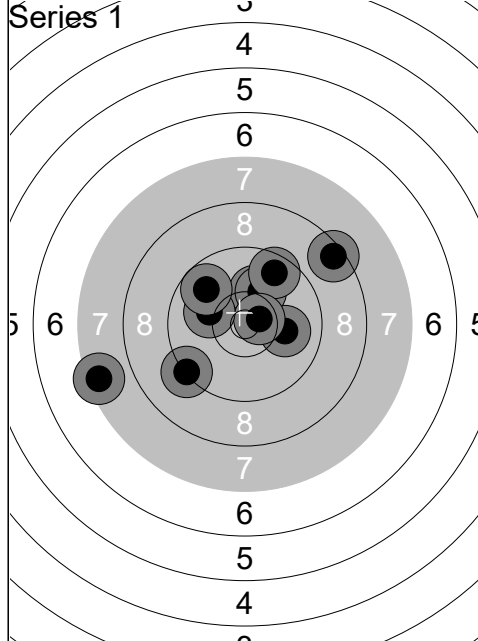

1:	8.5	↗
2:	10.0	→
3:	10.2	↑
4:	10.1	↑
5:	9.6	↑
6:	9.3	↙
7:	10.6x	→
8:	10.1	←
9:	9.8	↖
10:	7.5	←
<b>Series</b>	<b>92 ( 1x)</b>	
	<b>92 ( 1x)</b>	

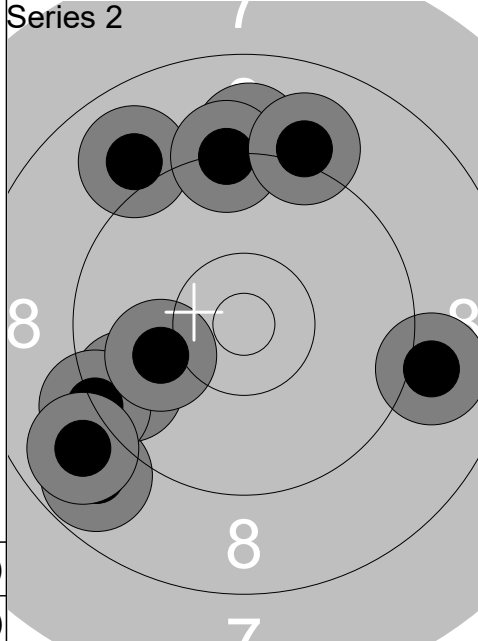

1:	9.1	↑
2:	8.8	↘
3:	9.6	↙
4:	9.0	→
5:	9.0	↖
6:	9.2	↙
7:	9.3	↑
8:	9.1	↑
9:	10.1	↙
10:	8.9	↙
<b>Series</b>	<b>89 ( 0x)</b>	
	<b>181 ( 1x)</b>	

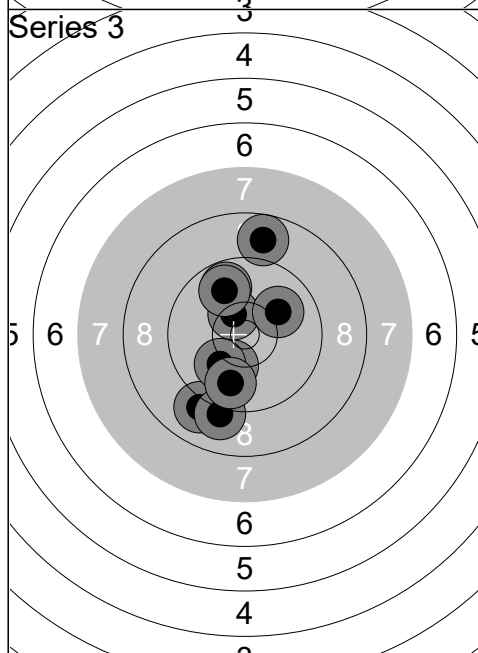

1:	9.0	↘
2:	9.8	↑
3:	10.2	↘
4:	10.4x	↖
5:	9.1	↘
6:	10.1	↙
7:	9.8	↘
8:	9.9	↑
9:	10.0	↗
10:	8.8	↑
<b>Series</b>	<b>93 ( 1x)</b>	
	<b>274 ( 2x)</b>	

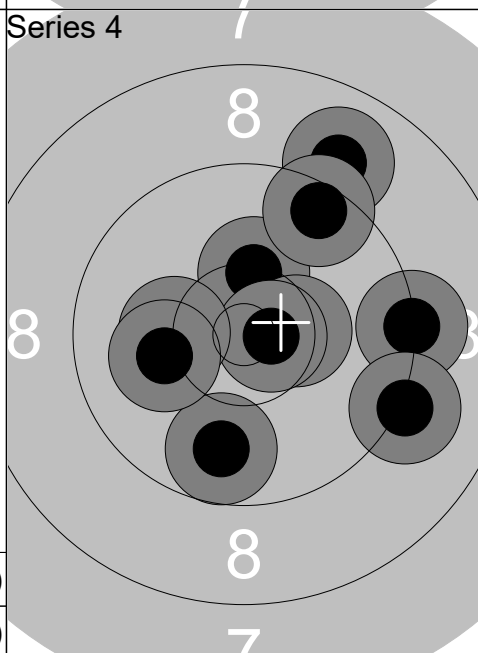

1:	10.3	↑
2:	9.0	↑
3:	9.8	↘
4:	10.4x	→
5:	9.3	→
6:	10.7x	→
7:	9.5	↑
8:	10.3	←
9:	10.1	←
10:	9.2	→
<b>Series</b>	<b>95 ( 2x)</b>	
	<b>369 ( 4x)</b>	

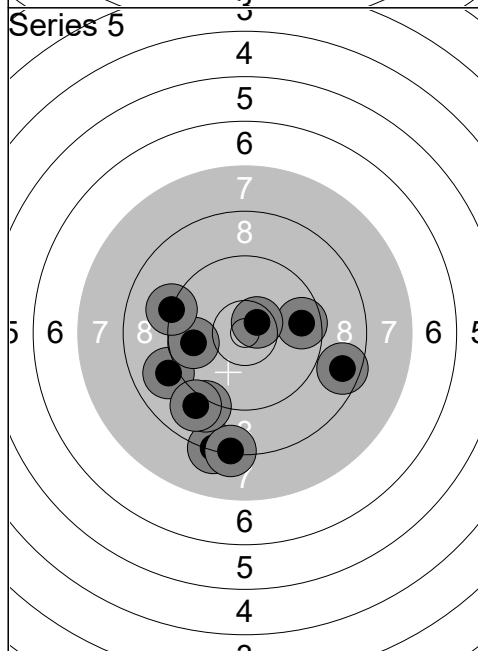

1:	9.0	←
2:	9.8	←
3:	9.7	→
4:	10.6x	↗
5:	8.3	↘
6:	9.2	←
7:	8.3	↘
8:	9.1	↘
9:	8.6	→
10:	9.0	↘
<b>Series</b>	<b>88 ( 1x)</b>	
	<b>457 ( 5x)</b>	

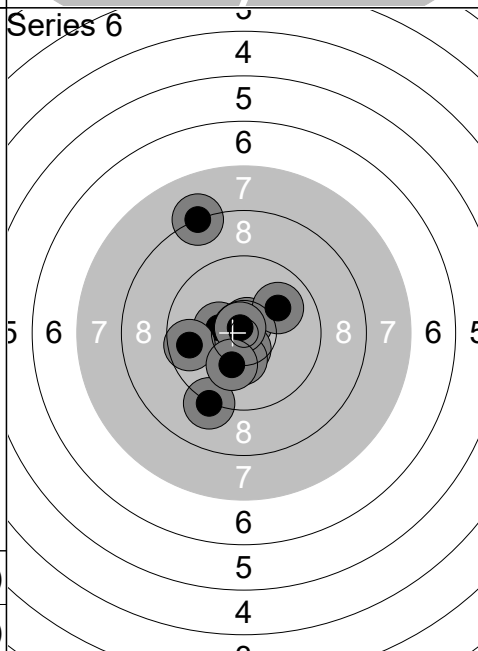

1:	10.4x	↙
2:	8.2	↑
3:	9.2	↘
4:	10.7x	↑
5:	10.6x	↘
6:	10.0	↗
7:	9.7	←
8:	10.4x	↘
9:	10.8x	↖
10:	10.2	↘
<b>Series</b>	<b>96 ( 5x)</b>	
	<b>553 ( 10x)</b>	

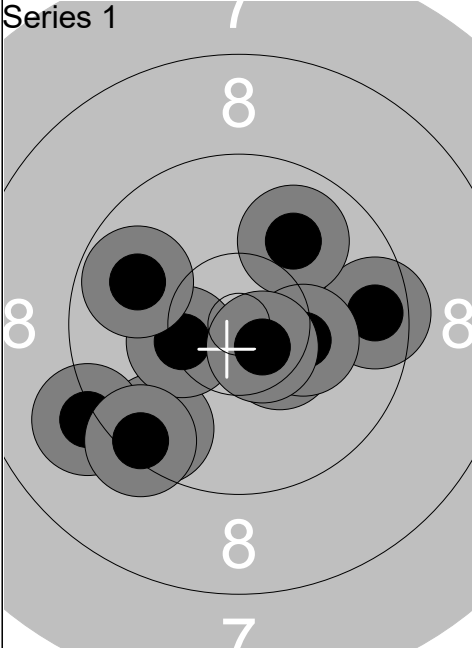
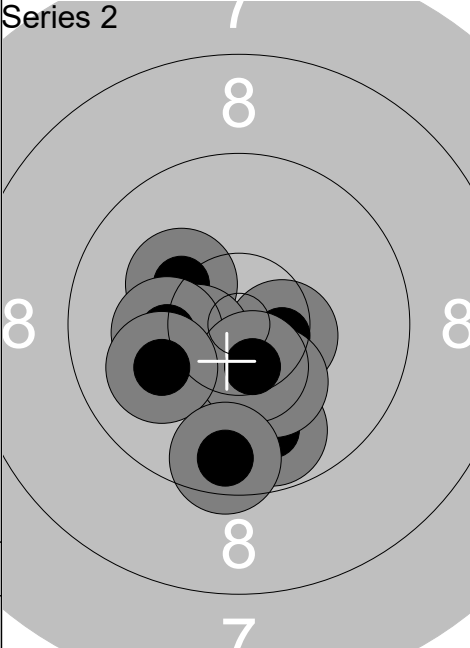
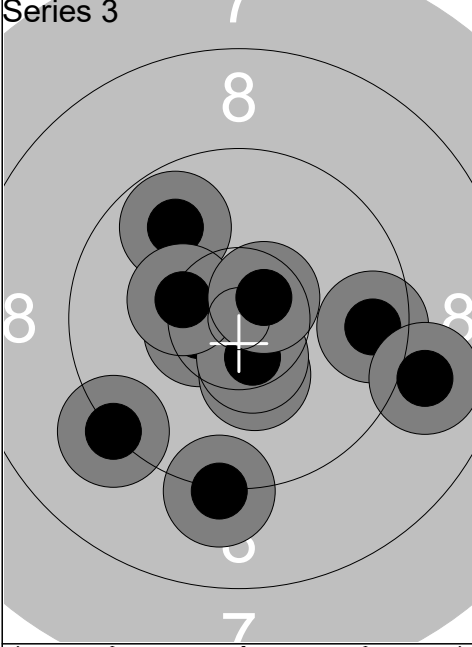
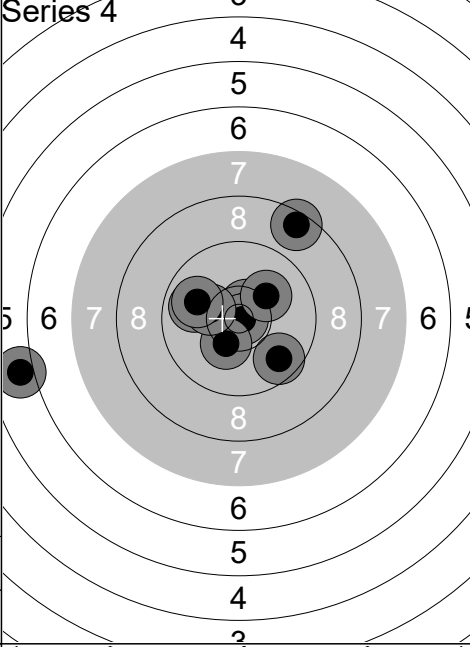
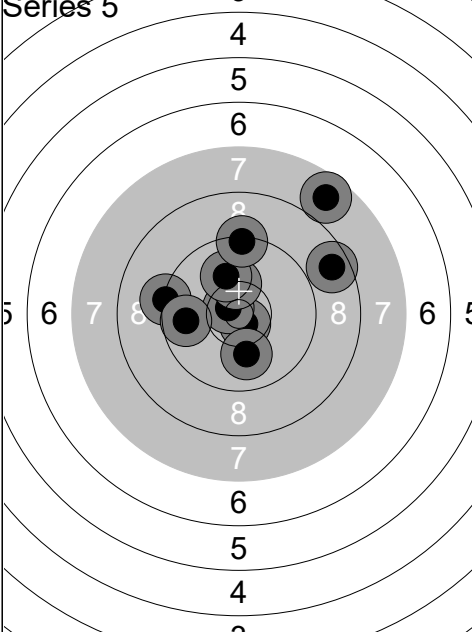
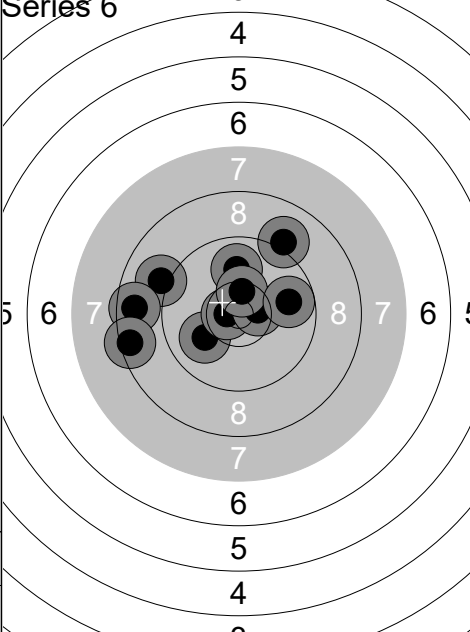
Relay	Lane	Johanna Reksten					
4	30	NOR	Wp	P			
Qual Day 3		Denmark Open Air 2026		Denmark Open Air 2026			
11.02.2026							
Series 1		1: 9.6 ↘ 2: 10.4 ← 3: 9.8 ← 4: 10.4x ↘ 5: 9.6 → 6: 9.2 ← 7: 9.4 ↘ 8: 9.9 ↗ 9: 10.3 → 10: 10.6x ↘	Series 94 ( 2x) 94 ( 2x)	Series 2		1: 10.4x ↘ 2: 9.8 ↘ 3: 10.2 ↖ 4: 10.5x → 5: 10.5x ← 6: 10.2 ← 7: 10.3 ↘ 8: 10.5x ↘ 9: 10.1 ← 10: 9.6 ↘	Series 98 ( 4x) 192 ( 6x)
Series 3		1: 9.2 ↘ 2: 9.6 → 3: 10.5x ← 4: 9.2 ↘ 5: 10.4x ↘ 6: 9.8 ↗ 7: 10.5x ↘ 8: 10.4 ← 9: 10.6x ↗ 10: 9.0 →	Series 95 ( 4x) 287 ( 10x)	Series 4		1: 10.6x ↗ 2: 5.9 ← 3: 9.9 ← 4: 10.9x → 5: 8.5 ↗ 6: 9.7 ↘ 7: 10.3 ↘ 8: 10.3 ← 9: 10.2 ↗ 10: 10.0 ←	Series 91 ( 2x) 378 ( 12x)
Series 5		1: 10.7x ↘ 2: 10.7x ↖ 3: 10.3 ↑ 4: 10.1 ↑ 5: 9.3 ← 6: 10.0 ↘ 7: 9.8 ← 8: 7.7 ↗ 9: 8.6 ↗ 10: 9.3 ↑	Series 92 ( 2x) 470 ( 14x)	Series 6		1: 9.1 ↗ 2: 10.0 ← 3: 10.7x ← 4: 10.0 ↑ 5: 10.5x → 6: 9.1 ← 7: 10.4x ↑ 8: 9.8 → 9: 8.6 ← 10: 8.4 ←	Series 93 ( 3x) 563 ( 17x)

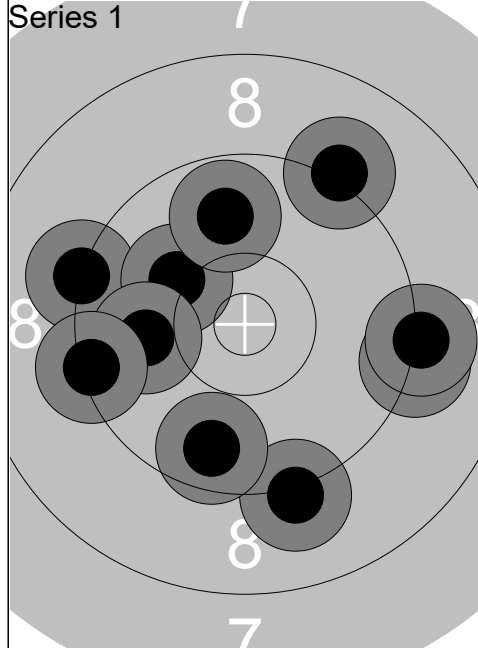

1: 9.2 ←
2: 9.2 ↓
3: 9.2 →
4: 9.2 →
5: 10.1 ↖
6: 9.9 ←
7: 9.8 ↑
8: 9.1 ↗
9: 9.3 ←
10: 9.7 ↓
<b>Series 91 (0x)</b>
<b>91 (0x)</b>

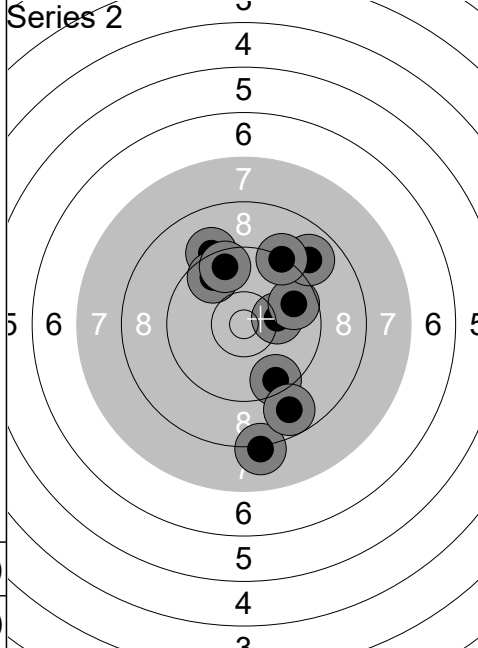

1: 8.1 ↓
2: 9.2 ↑
3: 10.2 →
4: 9.7 ↗
5: 9.6 ↑
6: 9.5 ↓
7: 9.7 →
8: 8.9 ↗
9: 9.3 ↗
10: 8.8 ↓
<b>Series 88 (0x)</b>
<b>179 (0x)</b>

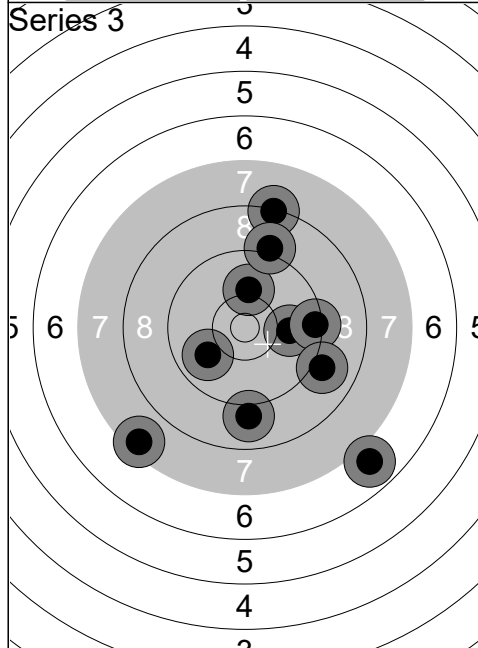

1: 9.9 ←
2: 10.0 →
3: 9.0 ↓
4: 10.1 ↑
5: 9.4 →
6: 6.9 ↓
7: 9.0 →
8: 8.3 ↑
9: 9.1 ↑
10: 7.5 ↙
<b>Series 86 (0x)</b>
<b>265 (0x)</b>

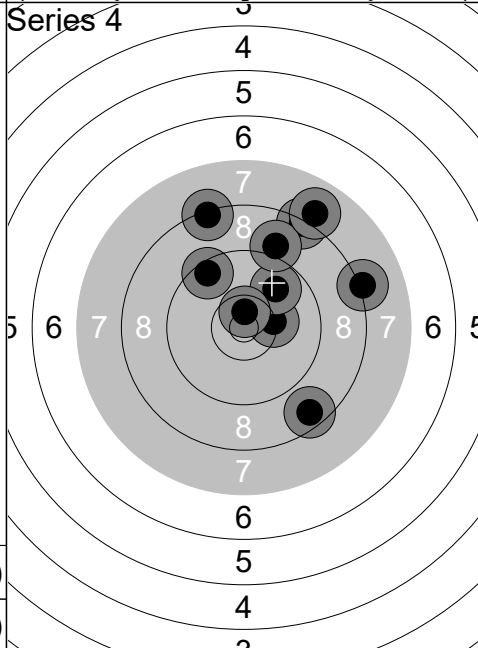

1: 8.3 ↑
2: 8.1 →
3: 8.6 ↓
4: 10.3 →
5: 9.8 ↗
6: 9.5 ↖
7: 8.3 ↗
8: 10.6x ↑
9: 9.0 ↑
10: 8.0 ↗
<b>Series 87 (1x)</b>
<b>352 (1x)</b>

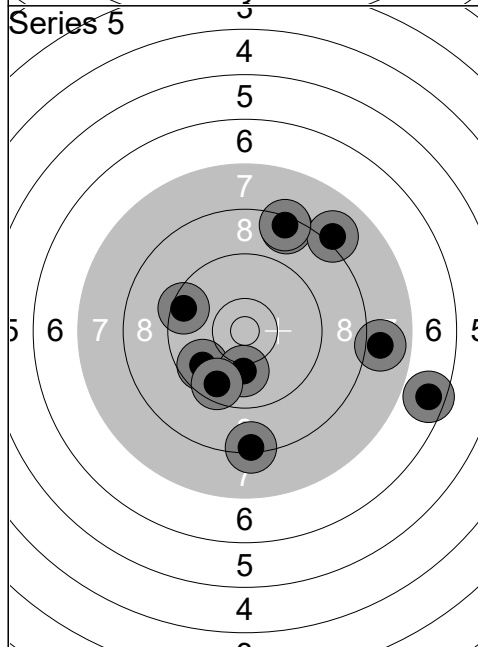

1: 9.5 ←
2: 8.5 ↑
3: 6.6 →
4: 8.1 ↗
5: 8.4 ↑
6: 9.7 ↖
7: 10.1 ↓
8: 9.6 ↓
9: 7.9 →
10: 8.3 ↓
<b>Series 82 (0x)</b>
<b>434 (1x)</b>

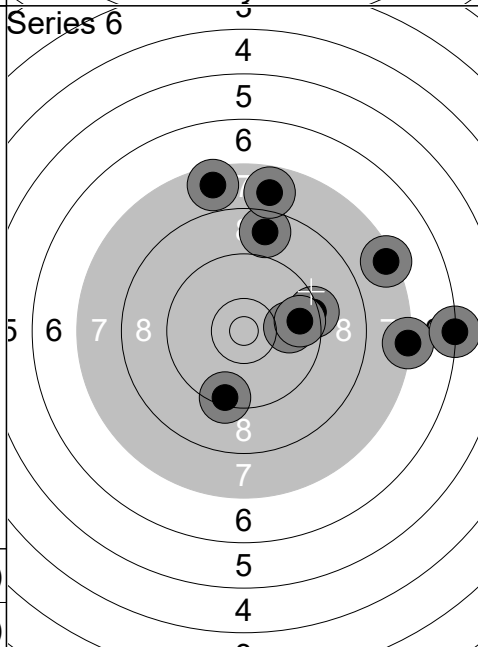

1: 8.7 ↑
2: 7.4 →
3: 9.4 ↓
4: 7.3 →
5: 9.4 →
6: 7.6 ↑
7: 9.9 →
8: 7.8 ↑
9: 6.3 →
10: 9.7 →
<b>Series 78 (0x)</b>
<b>512 (1x)</b>

Relay	Lane	Sofia Wern					
4	32	SWE		Wp	P		
11.02.2026		Denmark Open Air 2026		Denmark Open Air 2026			
Series 1 	1:	9.1	↘	Series 2 	1:	9.1	↓
	2:	9.5	↑		2:	7.7	↓
	3:	10.1	↓		3:	10.4x	↗
	4:	7.0	↘		4:	10.6x	↖
	5:	8.5	→		5:	8.1	↓
	6:	8.8	↘		6:	8.5	↘
	7:	8.5	←		7:	9.5	↓
	8:	9.3	→		8:	8.4	←
	9:	10.4x	→		9:	9.2	←
	10:	7.2	↓		10:	10.1	↖
Series		85 ( 1x)		Series		88 ( 2x)	
		85 ( 1x)				173 ( 3x)	
Series 3 	1:	8.7	↗	Series 4 	1:	9.1	↘
	2:	8.1	↑		2:	9.2	→
	3:	9.3	←		3:	7.7	←
	4:	7.3	↑		4:	9.0	↘
	5:	9.6	↑		5:	7.9	→
	6:	8.2	←		6:	10.6x	→
	7:	6.3	↘		7:	9.1	→
	8:	7.0	↘		8:	9.8	↘
	9:	9.4	→		9:	4.6	↓
	10:	10.6x	↗		10:	6.3	←
Series		81 ( 1x)		Series		79 ( 1x)	
		254 ( 4x)				333 ( 5x)	
Series 5 	1:	9.1	↗	Series 6 	1:	9.7	↘
	2:	8.2	↖		2:	8.0	↓
	3:	7.0	↘		3:	5.1	↘
	4:	7.9	↑		4:	10.8x	↖
	5:	10.0	↗		5:	7.4	←
	6:	9.6	↘		6:	8.6	↘
	7:	9.2	↑		7:	7.7	↘
	8:	9.8	←		8:	9.1	↗
	9:	8.7	↗		9:	10.7x	→
	10:	9.9	→		10:	10.3	↘
Series		85 ( 0x)		Series		83 ( 2x)	
		418 ( 5x)				501 ( 7x)	

Relay	Lane	Amy Lee					
4	33	DEN		Wp	P		
11.02.2026		Denmark Open Air 2026		Denmark Open Air 2026			
	1:	7.4	↓		1:	9.9	→
	2:	6.2	↑		2:	8.9	→
	3:	6.6	↑		3:	9.9	↑
	4:	9.0	→		4:	8.4	↙
	5:	9.6	→		5:	8.7	↙
	6:	7.6	↓		6:	9.8	←
	7:	9.8	→		7:	9.9	←
	8:	9.1	→		8:	10.3	↘
	9:	9.2	↓		9:	10.2	↗
	10:	9.6	↓		10:	9.8	→
Series		80 ( 0x)		Series		89 ( 0x)	
		80 ( 0x)				169 ( 0x)	
	1:	10.6x	↑		1:	9.6	↗
	2:	10.0	→		2:	9.8	↘
	3:	9.2	↘		3:	9.4	↖
	4:	8.3	↘		4:	8.3	↑
	5:	10.3	↓		5:	9.7	↘
	6:	9.6	←		6:	10.1	↘
	7:	9.8	→		7:	9.8	←
	8:	10.3	←		8:	9.9	↓
	9:	8.6	↘		9:	10.3	↘
	10:	10.1	↗		10:	9.9	↙
Series		93 ( 1x)		Series		91 ( 0x)	
		262 ( 1x)				353 ( 1x)	
	1:	9.2	↗		1:	8.6	↖
	2:	9.1	↗		2:	9.9	↖
	3:	10.5x	↗		3:	8.9	↑
	4:	10.2	↘		4:	10.1	↓
	5:	5.9	↗		5:	10.4x	↘
	6:	10.6x	↖		6:	9.4	↖
	7:	8.2	↘		7:	10.3	↑
	8:	10.6x	↗		8:	10.3	←
	9:	9.9	↓		9:	7.9	→
	10:	10.1	↑		10:	10.4x	→
Series		90 ( 3x)		Series		91 ( 2x)	
		443 ( 4x)				534 ( 6x)	

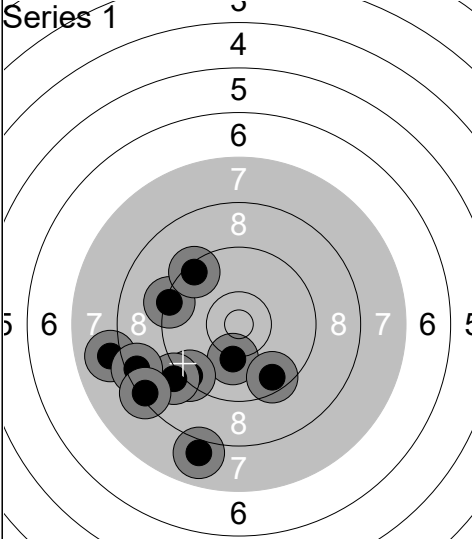
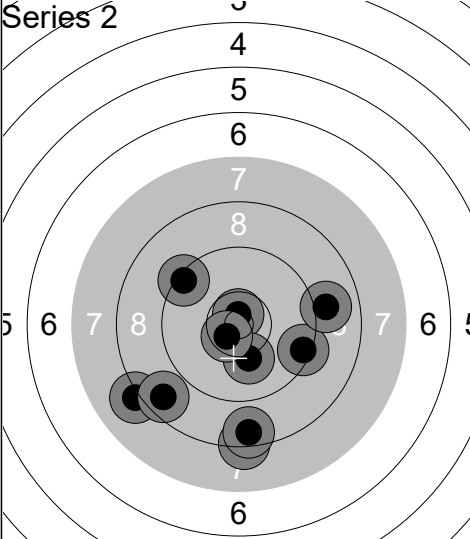
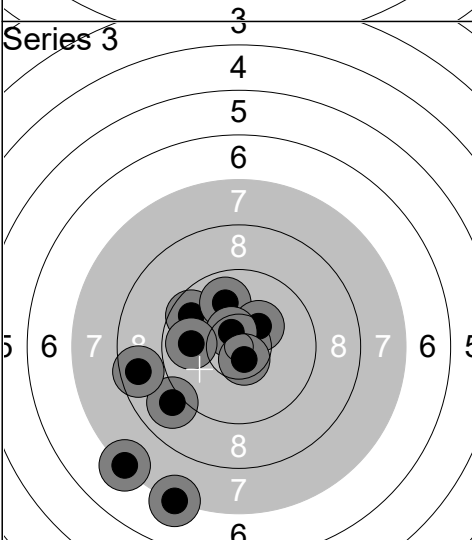
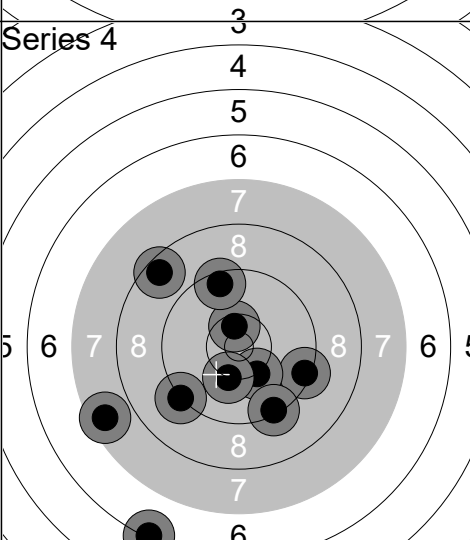
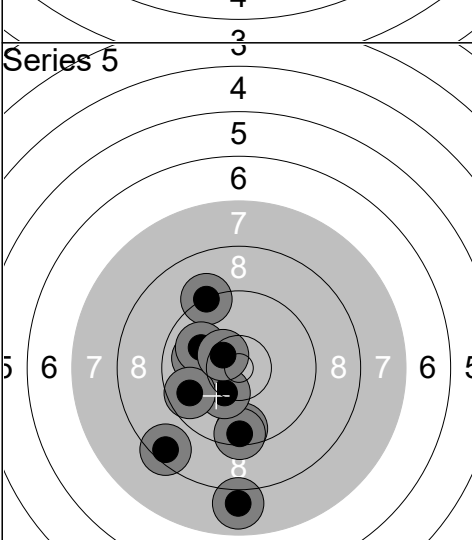
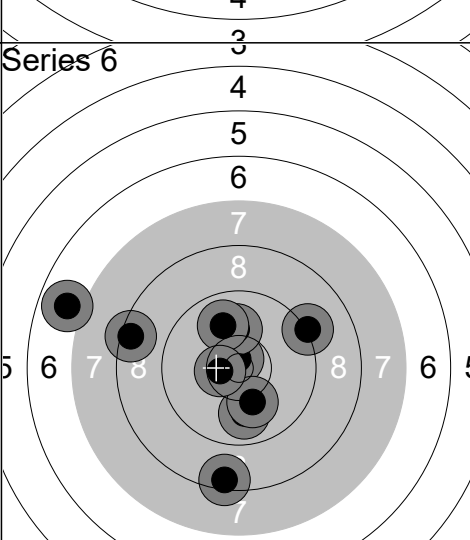
Relay	Lane	Cecilia Blom					
4	34	SWE		Wp	P		
11.02.2026		Denmark Open Air 2026		Denmark Open Air 2026			
Series 1 	1:	10.2	↓	Series 2 	1:	9.4	↖
	2:	8.0	←		2:	8.3	↓
	3:	8.0	↓		3:	9.4	→
	4:	9.3	←		4:	10.7x	↑
	5:	9.4	↗		5:	8.1	↖
	6:	9.4	↙		6:	8.5	↓
	7:	9.1	↖		7:	10.2	↓
	8:	8.5	←		8:	9.0	→
	9:	9.5	↓		9:	10.6x	↙
	10:	8.4	↖		10:	8.6	↙
Series		87 ( 0x)		Series		89 ( 2x)	
		87 ( 0x)				176 ( 2x)	
Series 3 	1:	7.3	↙	Series 4 	1:	9.4	→
	2:	9.7	↖		2:	6.3	↓
	3:	9.9	↑		3:	10.5x	↑
	4:	9.0	↙		4:	9.2	↙
	5:	10.3	↗		5:	10.2	↓
	6:	8.6	←		6:	10.2	↓
	7:	7.2	↓		7:	8.5	↗
	8:	10.6x	↗		8:	9.5	↑
	9:	9.9	←		9:	7.6	↖
	10:	10.6x	↓		10:	9.3	↓
Series		88 ( 2x)		Series		87 ( 1x)	
		264 ( 4x)				351 ( 5x)	
Series 5 	1:	9.2	↗	Series 6 	1:	8.5	←
	2:	9.6	↓		2:	9.9	↓
	3:	8.5	↙		3:	10.7x	↑
	4:	10.0	←		4:	8.4	↓
	5:	10.0	↖		5:	6.9	↖
	6:	9.5	↓		6:	10.1	↑
	7:	10.3	↓		7:	9.9	↑
	8:	9.7	←		8:	10.1	↓
	9:	10.5x	↖		9:	9.2	↗
	10:	7.9	↓		10:	10.5x	←
Series		91 ( 1x)		Series		89 ( 2x)	
		442 ( 6x)				531 ( 8x)	

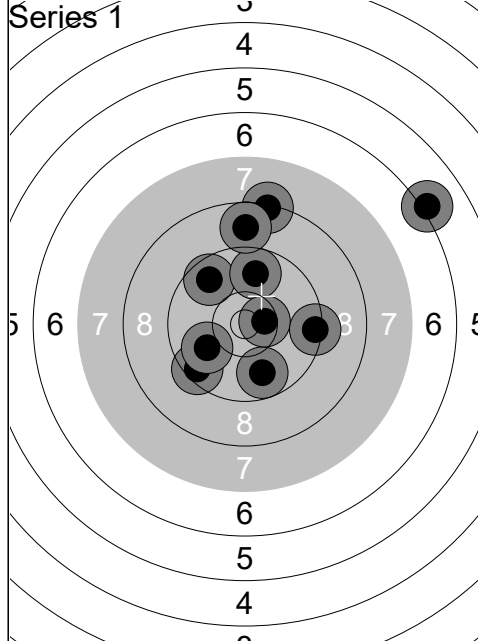

1:	8.3	↑
2:	9.7	↘
3:	9.5	↙
4:	9.8	↓
5:	9.8	↑
6:	10.5x	→
7:	10.0	←
8:	9.4	→
9:	6.1	↗
10:	8.8	↑

Series	87 ( 1x)
	87 ( 1x)

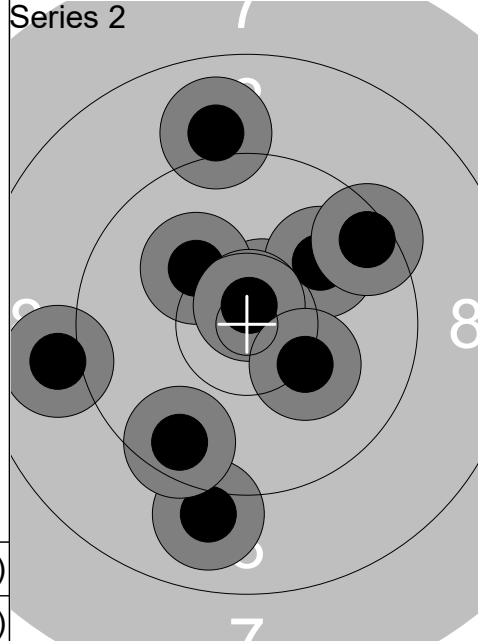

1:	10.6x	↗
2:	9.0	↓
3:	10.0	↗
4:	9.6	↓
5:	10.2	↖
6:	9.5	↗
7:	10.8x	↑
8:	9.0	←
9:	9.0	↑
10:	10.2	↘

Series	95 ( 2x)
	182 ( 3x)

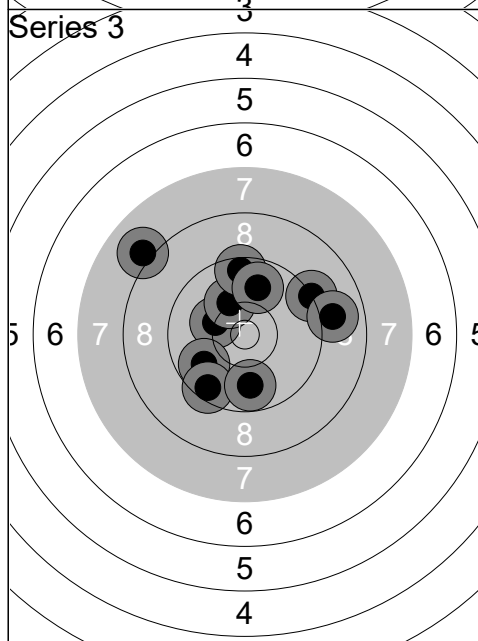

1:	10.2	←
2:	9.8	↙
3:	10.2	↑
4:	8.0	↖
5:	9.5	↑
6:	9.5	↙
7:	9.9	↑
8:	9.2	↗
9:	9.8	↓
10:	8.9	→

Series	90 ( 0x)
	272 ( 3x)

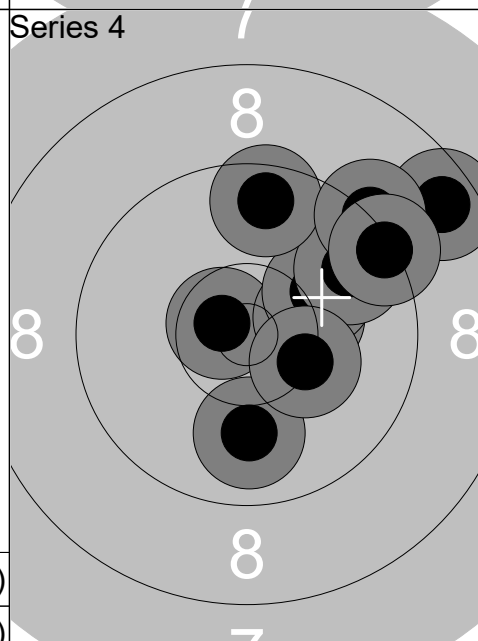

1:	8.6	↗
2:	10.7x	↖
3:	10.3	→
4:	10.1	↗
5:	9.7	↗
6:	9.6	↑
7:	10.0	↓
8:	10.3	↘
9:	9.2	↗
10:	9.3	↗

Series	94 ( 1x)
	366 ( 4x)

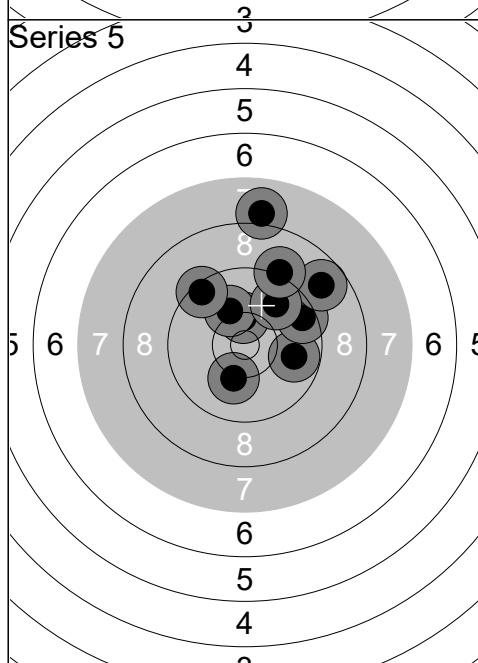

1:	10.3	↑
2:	9.8	→
3:	9.5	↗
4:	8.0	↑
5:	10.1	↖
6:	8.8	↗
7:	9.4	↖
8:	9.8	↗
9:	10.2	↓
10:	9.1	↑

Series	91 ( 0x)
	457 ( 4x)

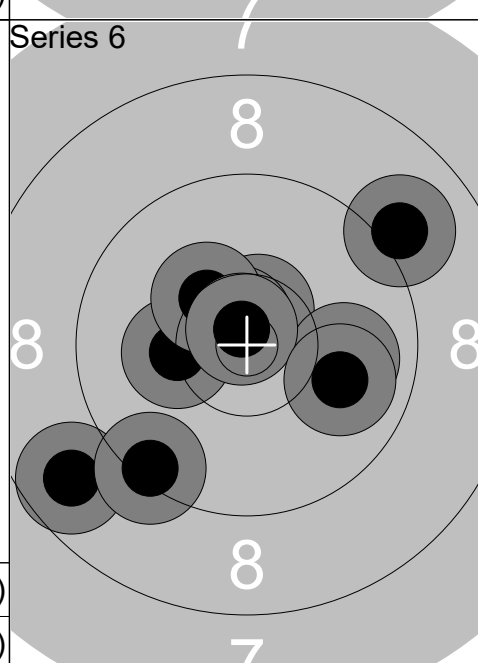

1:	10.2	←
2:	10.6x	↑
3:	8.7	↙
4:	10.7x	↑
5:	10.0	→
6:	10.3	↖
7:	10.8x	↑
8:	10.0	↘
9:	9.4	↙
10:	9.0	↗

Series	96 ( 3x)
	553 ( 7x)

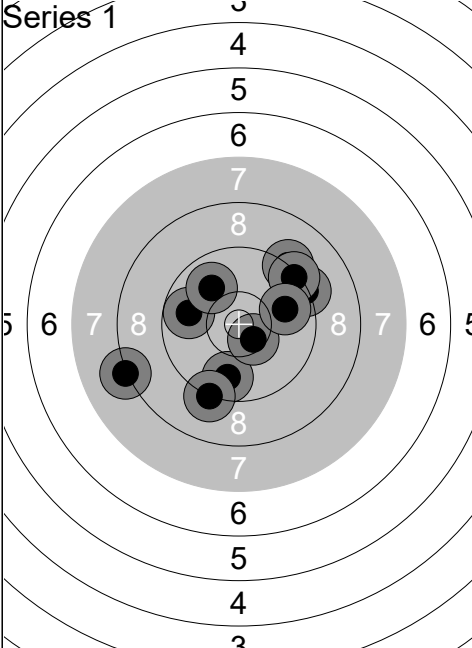
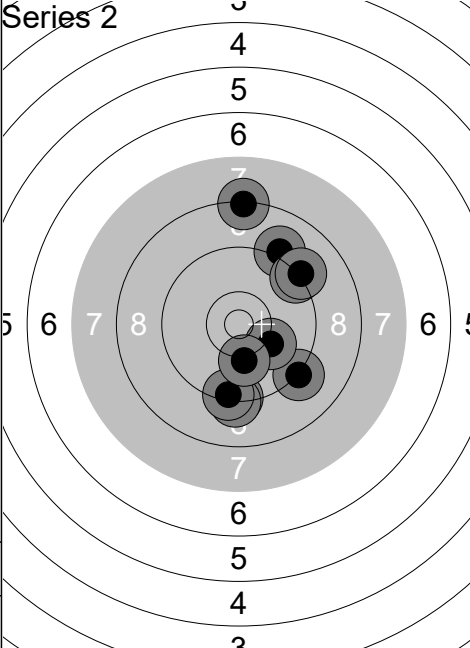
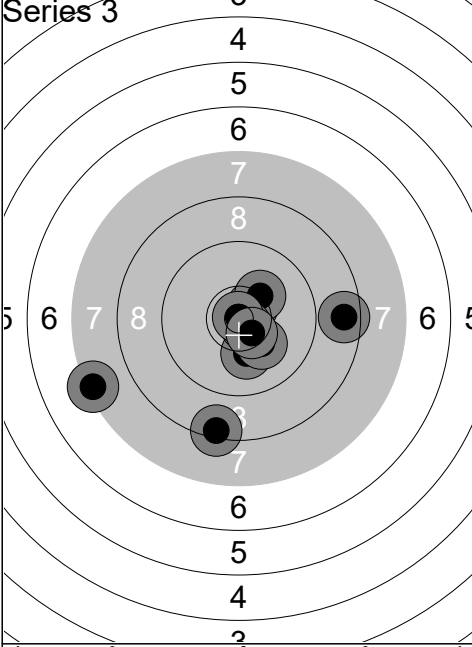
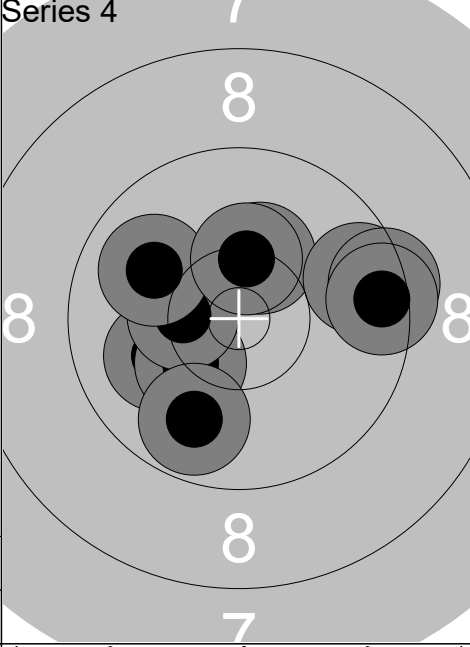
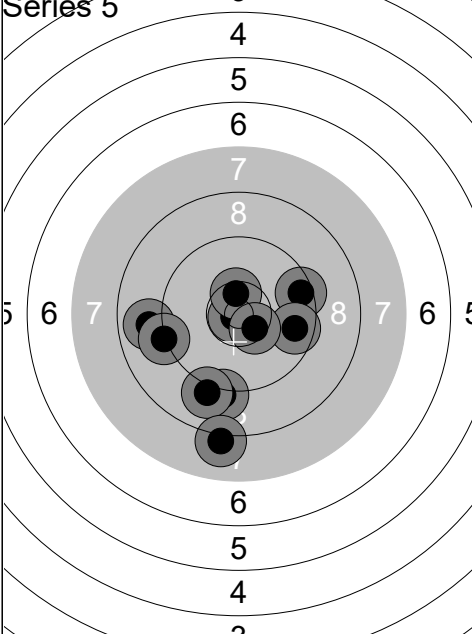
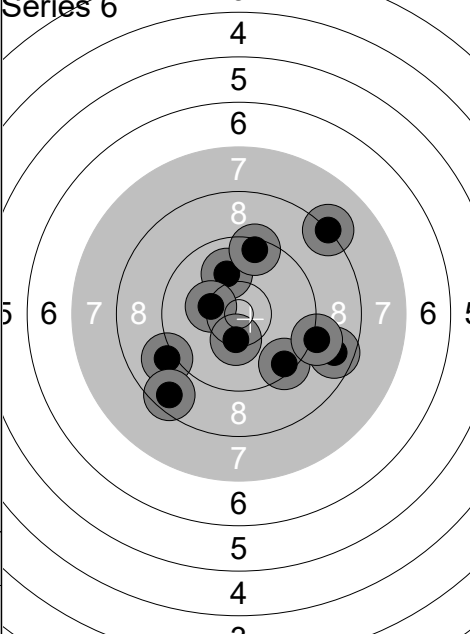
Relay	Lane	Louise Rasmussen					
4	36	DEN	Wp	P			
Qual Day 3		Denmark Open Air 2026		Denmark Open Air 2026			
11.02.2026							
Series 1 	1:	9.8	←	Series 2 	1:	9.3	↓
	2:	8.2	←		2:	9.2	↘
	3:	9.7	↓		3:	8.3	↑
	4:	9.3	→		4:	10.1	↘
	5:	10.5x	↘		5:	9.2	↓
	6:	9.2	↗		6:	9.1	↗
	7:	9.3	↗		7:	9.3	↗
	8:	9.9	→		8:	9.4	↓
	9:	9.9	↖		9:	9.2	↗
	10:	9.2	↓		10:	10.1	↓
Series	90 ( 1x)			Series	91 ( 0x)		
	90 ( 1x)				181 ( 1x)		
Series 3 	1:	10.6x	↗	Series 4 	1:	10.1	←
	2:	10.2	↓		2:	10.3	↗
	3:	7.4	←		3:	10.3	↘
	4:	10.3	↗		4:	10.4x	←
	5:	10.7x	↘		5:	9.7	→
	6:	8.6	→		6:	9.8	↓
	7:	10.9x	↗		7:	10.0	↖
	8:	8.4	↓		8:	9.4	→
	9:	10.2	↘		9:	10.3	↗
	10:	10.5x	↘		10:	9.5	→
Series	93 ( 4x)			Series	96 ( 1x)		
	274 ( 5x)				370 ( 6x)		
Series 5 	1:	10.8x	←	Series 6 	1:	9.1	←
	2:	10.5x	↗		2:	10.0	↗
	3:	8.9	←		3:	10.3	←
	4:	9.2	←		4:	10.4x	↓
	5:	9.5	→		5:	9.4	↘
	6:	9.7	→		6:	8.6	↘
	7:	9.1	↓		7:	9.5	↗
	8:	10.5x	↘		8:	8.2	↗
	9:	9.1	↓		9:	8.7	↘
	10:	8.1	↓		10:	9.1	↘
Series	91 ( 3x)			Series	90 ( 1x)		
	461 ( 9x)				551 ( 10x)		

Relay	Lane	Sarah Tauermann		
4	37	GER	Wp	P
Qual Day 3		Denmark Open Air 2026		Denmark Open Air 2026
11.02.2026				
Series 1 	1: 10.1 ↘	Series 2 	1: 9.9 ↑	
	2: 10.4x ↙		2: 10.1 ↖	
	3: 10.0 ↑		3: 8.9 →	
	4: 8.4 ↗		4: 9.4 ↗	
	5: 10.3 →		5: 10.0 ↓	
	6: 10.1 ←		6: 10.8x ↓	
	7: 9.4 ↗		7: 9.9 ↙	
	8: 9.8 ←		8: 10.3 ↓	
	9: 8.7 ↘		9: 10.1 ↑	
	10: 10.6x ↙		10: 8.8 ↗	
	Series 94 ( 2x)		Series 93 ( 1x)	
	94 ( 2x)		187 ( 3x)	
Series 3 	1: 9.1 →	Series 4 	1: 10.0 ↗	
	2: 10.6x ↖		2: 10.7x ↙	
	3: 10.1 ↗		3: 9.8 ↓	
	4: 9.4 ↗		4: 9.7 ↗	
	5: 10.6x ↘		5: 10.2 ↑	
	6: 9.0 ↑		6: 10.7x ↗	
	7: 10.3 ↑		7: 10.5x ↖	
	8: 9.6 ↑		8: 10.3 ↓	
	9: 9.8 ↖		9: 10.5x →	
	10: 10.7x ↙		10: 9.7 →	
	Series 95 ( 3x)		Series 97 ( 4x)	
	282 ( 6x)		379 (10x)	
Series 5 	1: 10.2 →	Series 6 	1: 9.4 ↖	
	2: 10.2 →		2: 10.5x ↙	
	3: 10.5x ↙		3: 9.2 ↑	
	4: 10.0 ←		4: 10.1 ↖	
	5: 9.5 ↑		5: 9.5 ↓	
	6: 9.4 ↑		6: 10.4x ↙	
	7: 10.7x ↙		7: 8.8 ↑	
	8: 10.6x ↙		8: 9.9 ↖	
	9: 10.3 →		9: 10.3 ↗	
	10: 9.0 ↓		10: 10.1 ←	
	Series 97 ( 3x)		Series 94 ( 2x)	
	476 (13x)		570 (15x)	