

| Relay | Lane | Malik Lindharth | | |
|---------------------|---------------------|-----------------------|---------------------|-----------------------|
| 1 | 23 | DEN | MJ | R |
| Qual Day 3 | | Denmark Open Air 2026 | | Denmark Open Air 2026 |
| 11.02.2026 | | Denmark Open Air 2026 | | Denmark Open Air 2026 |
| Series 1 | 1: 9.6 ↘ | Series 2 | 1: 10.7x ↗ | |
| | 2: 10.5x ↘ | | 2: 10.1 ↑ | |
| | 3: 10.3x → | | 3: 10.0 ↘ | |
| | 4: 9.6 ↓ | | 4: 10.8x ↘ | |
| | 5: 10.0 ↗ | | 5: 10.5x ↓ | |
| | 6: 10.5x ↗ | | 6: 10.1 ↘ | |
| | 7: 10.2x ↓ | | 7: 10.3x ↓ | |
| | 8: 10.1 ↖ | | 8: 10.3x ↓ | |
| | 9: 10.0 ← | | 9: 10.6x ↖ | |
| | 10: 10.3x ↘ | | 10: 9.6 ← | |
| | Series 101.1 | | Series 103.0 | |
| | 101.1 | | 204.1 | |
| Series 3 | 1: 9.9 ↖ | Series 4 | 1: 10.5x ↘ | |
| | 2: 10.6x → | | 2: 10.8x ← | |
| | 3: 10.2x ↖ | | 3: 9.5 ↖ | |
| | 4: 10.5x → | | 4: 10.1 ↖ | |
| | 5: 10.5x ← | | 5: 10.2x ↖ | |
| | 6: 10.1 ↑ | | 6: 10.7x ← | |
| | 7: 9.5 → | | 7: 10.4x → | |
| | 8: 10.3x ↖ | | 8: 10.1 ↖ | |
| | 9: 9.7 ↗ | | 9: 9.7 ↗ | |
| | 10: 9.5 ← | | 10: 10.4x → | |
| | Series 100.8 | | Series 102.4 | |
| | 304.9 | | 407.3 | |
| Series 5 | 1: 9.6 ↖ | Series 6 | 1: 10.7x → | |
| | 2: 10.1 ↘ | | 2: 10.6x ↓ | |
| | 3: 9.8 ↖ | | 3: 10.3x ↗ | |
| | 4: 10.2x ↖ | | 4: 9.6 → | |
| | 5: 10.1 ↖ | | 5: 10.6x ↓ | |
| | 6: 9.9 → | | 6: 10.2x ↖ | |
| | 7: 10.4x ← | | 7: 9.8 ↖ | |
| | 8: 10.4x ↗ | | 8: 10.6x → | |
| | 9: 9.9 ↑ | | 9: 10.3x → | |
| | 10: 9.6 ↖ | | 10: 10.5x ↗ | |
| | Series 100.0 | | Series 103.2 | |
| | 507.3 | | 610.5 | |

| Relay | Lane | Villads Greve | | |
|---------------------|---------------------|-----------------------|-------------|-----------------------|
| 1 | 24 | DEN | MJ | R |
| Qual Day 3 | | Denmark Open Air 2026 | | Denmark Open Air 2026 |
| 11.02.2026 | | Denmark Open Air 2026 | | Denmark Open Air 2026 |
| Series 1 | 1: 10.5x ↓ | Series 2 | 1: 10.2x ← | |
| | 2: 9.8 ↓ | | 2: 10.2x ↗ | |
| | 3: 10.3x → | | 3: 10.7x → | |
| | 4: 10.2x ↑ | | 4: 10.2x ↓ | |
| | 5: 10.6x ↓ | | 5: 9.4 → | |
| | 6: 10.6x ↗ | | 6: 9.9 ↖ | |
| | 7: 10.9x | | 7: 10.5x ← | |
| | 8: 9.2 ↓ | | 8: 10.3x ↗ | |
| | 9: 9.6 ↗ | | 9: 9.5 ↓ | |
| | 10: 8.8 → | | 10: 9.8 ↓ | |
| | Series 100.5 | Series 100.7 | | |
| | 100.5 | | 201.2 | |
| Series 3 | 1: 10.2x ← | Series 4 | 1: 9.9 ↑ | |
| | 2: 10.7x ↗ | | 2: 10.0 ↖ | |
| | 3: 10.0 ↗ | | 3: 10.0 → | |
| | 4: 10.2x ↖ | | 4: 10.7x ← | |
| | 5: 9.6 ← | | 5: 10.0 ↗ | |
| | 6: 9.9 ← | | 6: 10.0 ↓ | |
| | 7: 10.1 → | | 7: 10.6x ↗ | |
| | 8: 9.4 ↓ | | 8: 10.4x ↓ | |
| | 9: 8.9 ↓ | | 9: 10.6x ↓ | |
| | 10: 10.7x ↗ | | 10: 10.5x ↓ | |
| | Series 99.7 | Series 102.7 | | |
| | 300.9 | | 403.6 | |
| Series 5 | 1: 10.7x → | Series 6 | 1: 8.6 ↓ | |
| | 2: 10.1 ↗ | | 2: 10.2x ← | |
| | 3: 9.9 ↑ | | 3: 9.5 ← | |
| | 4: 9.9 ↑ | | 4: 9.4 ↓ | |
| | 5: 10.0 ↓ | | 5: 10.1 ← | |
| | 6: 9.7 → | | 6: 10.1 ↖ | |
| | 7: 9.7 ↓ | | 7: 10.1 ↗ | |
| | 8: 9.7 → | | 8: 10.5x ↑ | |
| | 9: 10.3x → | | 9: 10.0 → | |
| | 10: 10.3x ↖ | | 10: 10.8x → | |
| | Series 100.3 | Series 99.3 | | |
| | 503.9 | | 603.2 | |

| Relay | Lane | Sander Vampli | | |
|--|--------------|--|--------------|-----------------------|
| 1 | 25 | NOR | MJ | R |
| Qual Day 3 | | Denmark Open Air 2026 | | Denmark Open Air 2026 |
| 11.02.2026 | | | | |
| Series 1  | 1: 10.3x ↘ | Series 2  | 1: 10.6x ← | |
| | 2: 9.9 ← | | 2: 10.4x ↑ | |
| | 3: 10.2x ← | | 3: 10.4x ↓ | |
| | 4: 9.4 → | | 4: 10.4x ↗ | |
| | 5: 9.7 ↘ | | 5: 10.0 → | |
| | 6: 10.7x ↘ | | 6: 10.7x ↗ | |
| | 7: 10.7x ↘ | | 7: 10.7x ↗ | |
| | 8: 10.6x ↗ | | 8: 10.7x ↓ | |
| | 9: 10.7x ↗ | | 9: 10.3x ↘ | |
| | 10: 9.8 ← | | 10: 9.9 ↑ | |
| | Series 102.0 | | Series 104.1 | |
| | 102.0 | | 206.1 | |
| Series 3  | 1: 10.1 ↖ | Series 4  | 1: 10.2x ← | |
| | 2: 10.2x ↑ | | 2: 10.7x ↘ | |
| | 3: 10.0 ↖ | | 3: 10.2x ↓ | |
| | 4: 10.4x ← | | 4: 10.5x ↘ | |
| | 5: 10.2x ← | | 5: 10.6x ↘ | |
| | 6: 10.0 → | | 6: 10.2x ← | |
| | 7: 10.6x ↓ | | 7: 10.0 → | |
| | 8: 10.2x ↗ | | 8: 10.5x → | |
| | 9: 9.5 ← | | 9: 10.7x ↘ | |
| | 10: 10.7x ↓ | | 10: 10.4x ↘ | |
| | Series 101.9 | | Series 104.0 | |
| | 308.0 | | 412.0 | |
| Series 5  | 1: 10.4x ↘ | Series 6  | 1: 10.4x → | |
| | 2: 10.4x ↘ | | 2: 10.5x → | |
| | 3: 10.7x ↓ | | 3: 10.1 ↘ | |
| | 4: 10.4x ← | | 4: 10.6x ← | |
| | 5: 10.3x ← | | 5: 9.9 ← | |
| | 6: 10.8x ← | | 6: 10.2x → | |
| | 7: 9.8 ← | | 7: 10.6x → | |
| | 8: 10.1 ← | | 8: 10.8x ↗ | |
| | 9: 10.7x ↘ | | 9: 10.0 ↓ | |
| | 10: 10.2x ← | | 10: 10.5x ↘ | |
| | Series 103.8 | | Series 103.6 | |
| | 515.8 | | 619.4 | |

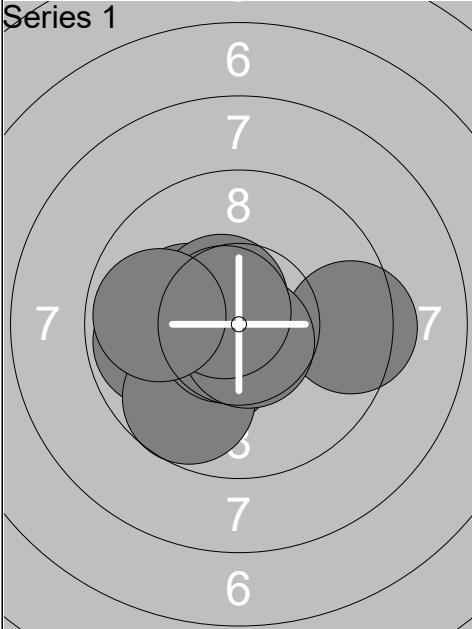
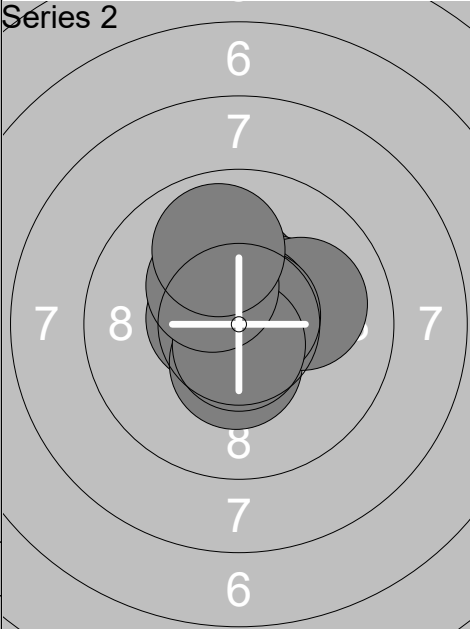
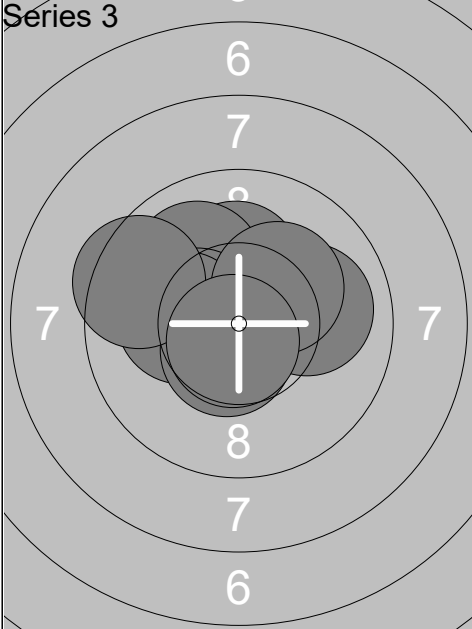
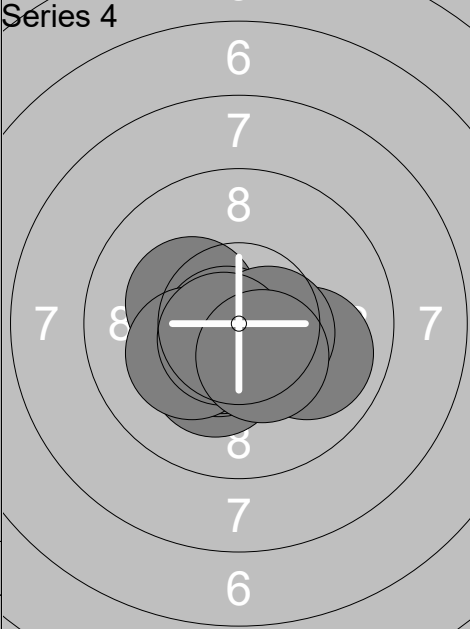
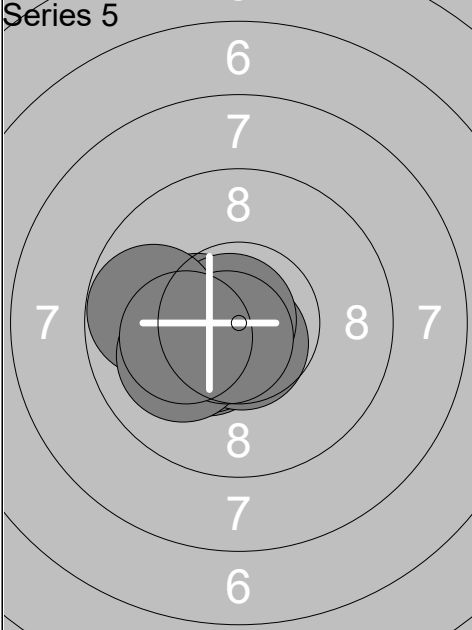
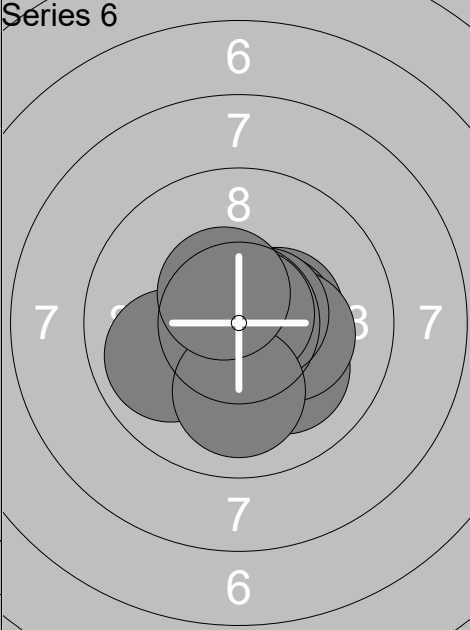
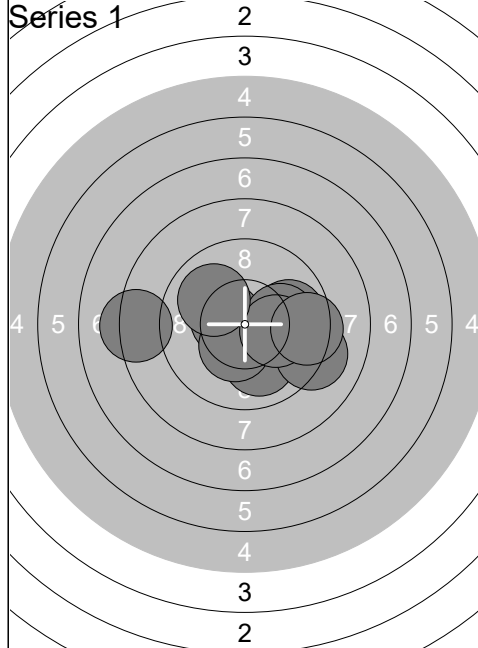

| |
|--------------------|
| 1: 10.0 ↓ |
| 2: 10.5x↙ |
| 3: 8.3 ← |
| 4: 10.4x↘ |
| 5: 9.9 → |
| 6: 9.1 → |
| 7: 10.1 → |
| 8: 10.2x→ |
| 9: 9.4 → |
| 10: 10.0 ↖ |
| Series 97.9 |
| 97.9 |

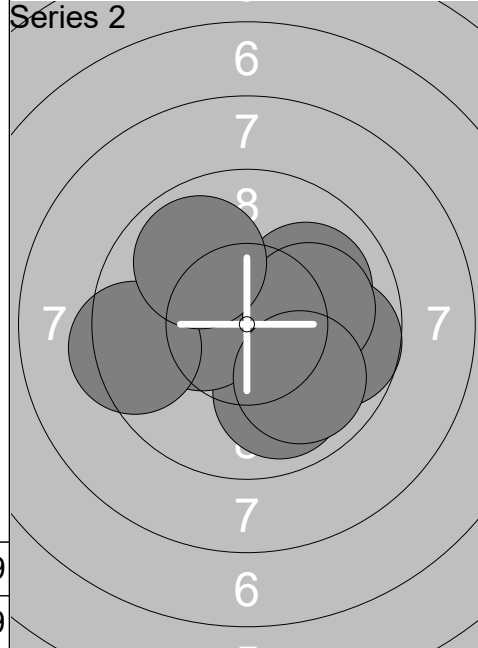

| |
|--------------------|
| 1: 10.4x↖ |
| 2: 10.0 ↗ |
| 3: 10.0 → |
| 4: 9.9 ↓ |
| 5: 10.4x↙ |
| 6: 9.7 → |
| 7: 10.1 → |
| 8: 9.4 ← |
| 9: 9.9 ↗ |
| 10: 10.0 ↘ |
| Series 99.8 |
| 197.7 |

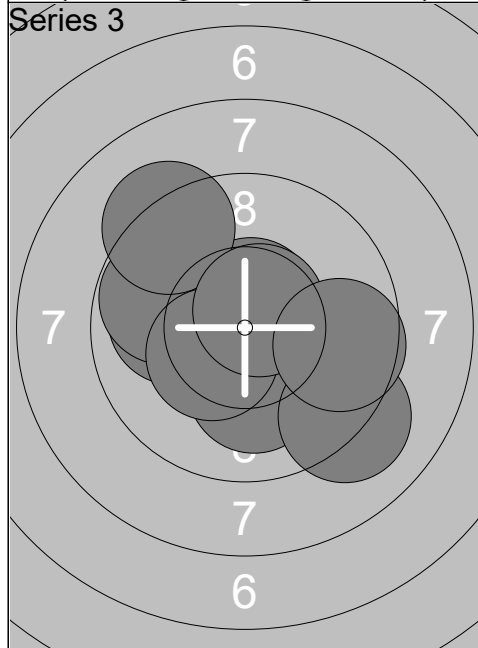

| |
|---------------------|
| 1: 10.5x↘ |
| 2: 10.6x↗ |
| 3: 10.2x↓ |
| 4: 9.1 ↓ |
| 5: 10.0 ← |
| 6: 9.8 ← |
| 7: 10.4x↙ |
| 8: 9.2 ↗ |
| 9: 10.6x↗ |
| 10: 9.6 → |
| Series 100.0 |
| 297.7 |

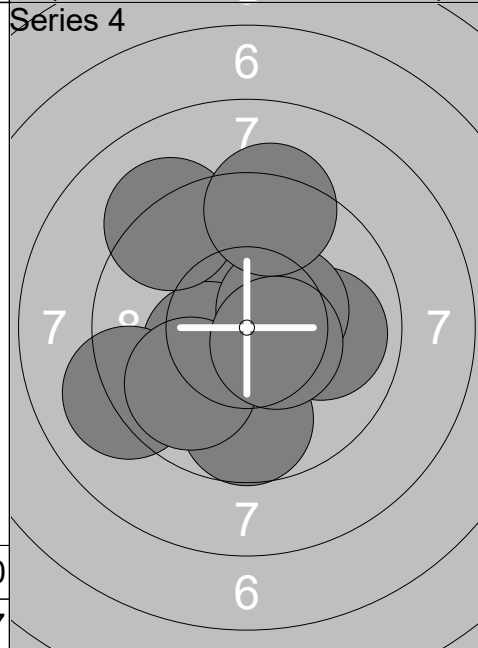

| |
|--------------------|
| 1: 10.7x↗ |
| 2: 10.4x↙ |
| 3: 9.1 ← |
| 4: 9.9 → |
| 5: 9.2 ↗ |
| 6: 9.7 ↓ |
| 7: 10.4x↗ |
| 8: 9.9 ↙ |
| 9: 9.3 ↗ |
| 10: 10.5x↘ |
| Series 99.1 |
| 396.8 |

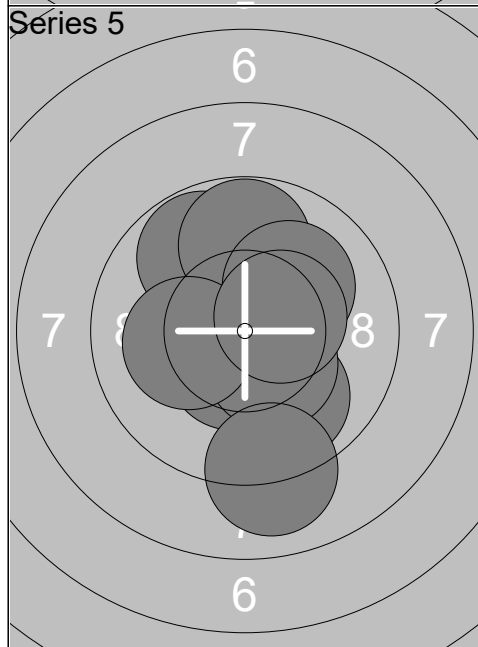

| |
|---------------------|
| 1: 9.9 ↓ |
| 2: 10.5x↘ |
| 3: 10.2x↗ |
| 4: 10.4x↘ |
| 5: 9.8 ↗ |
| 6: 9.8 ↗ |
| 7: 9.0 ↓ |
| 8: 10.2x↙ |
| 9: 10.1 ↗ |
| 10: 10.4x↗ |
| Series 100.3 |
| 497.1 |

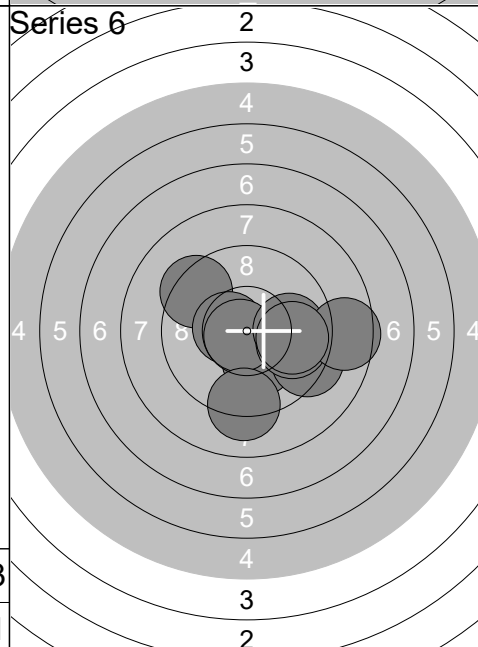

| |
|--------------------|
| 1: 10.2x↓ |
| 2: 9.4 ↖ |
| 3: 10.5x↙ |
| 4: 10.7x↙ |
| 5: 9.3 ↘ |
| 6: 9.8 → |
| 7: 9.1 ↓ |
| 8: 9.9 → |
| 9: 8.5 → |
| 10: 9.8 → |
| Series 97.2 |
| 594.3 |

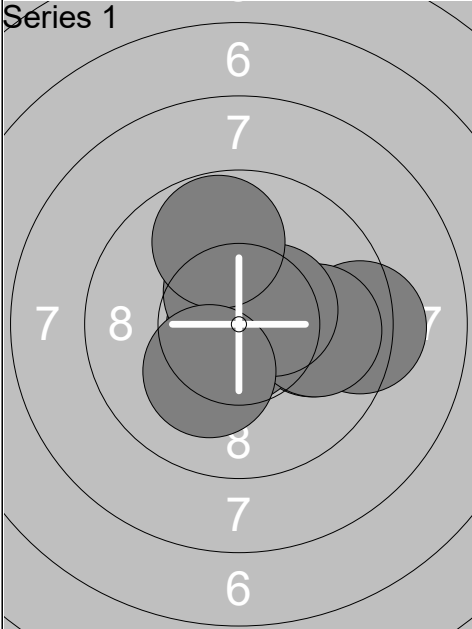
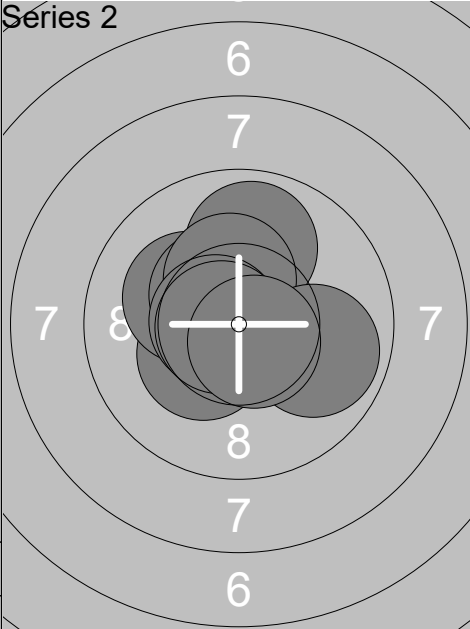
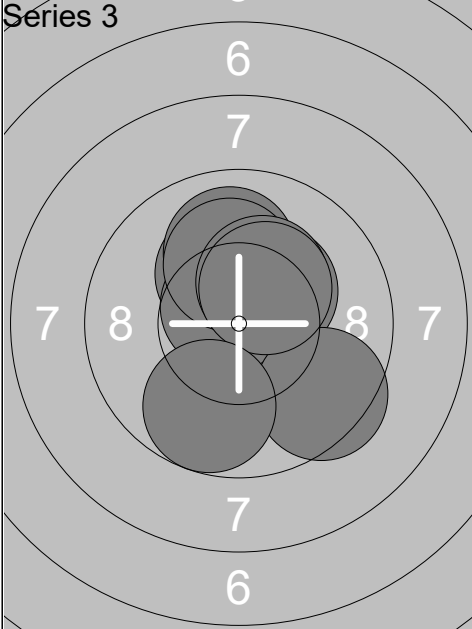
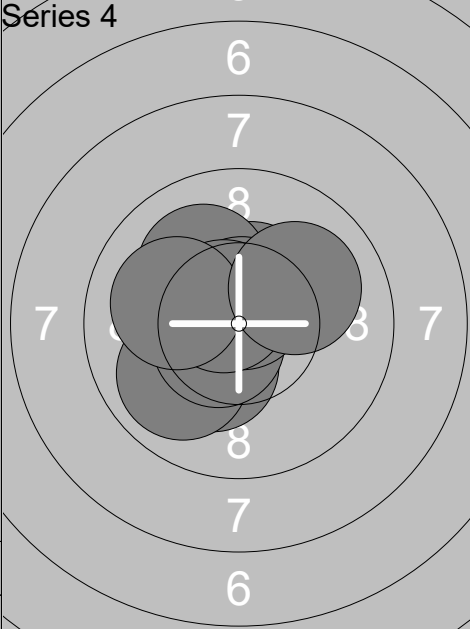
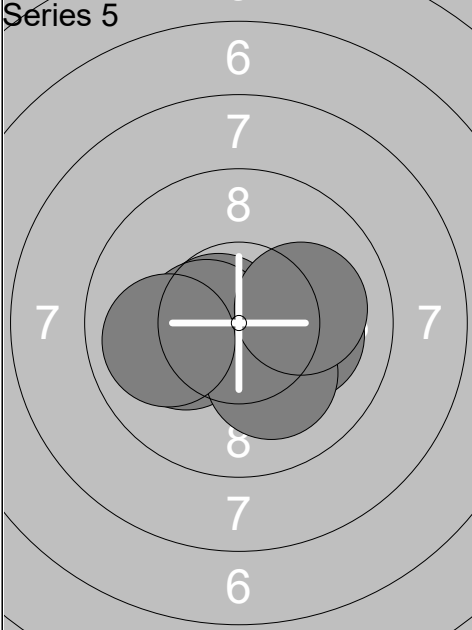
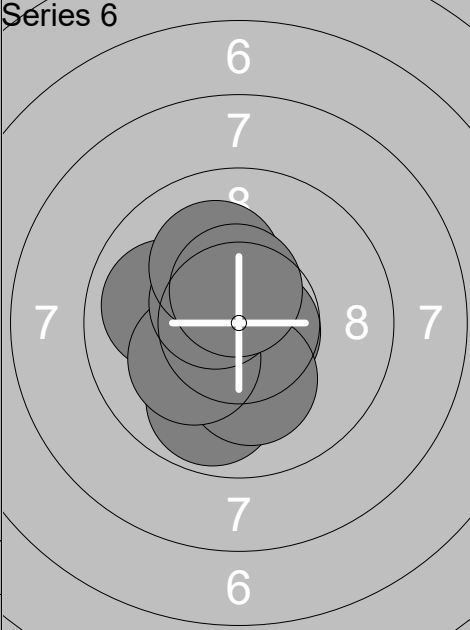
| Relay | Lane | Storm Franzen | | | |
|---|---------------------|---|---------------------|-----------------------|---|
| 1 | 27 | DEN | | MJ | R |
| 11.02.2026 | | Denmark Open Air 2026 | | Denmark Open Air 2026 | |
| Series 1  | 1: 9.3 → | Series 2  | 1: 10.8x ↘ | | |
| | 2: 10.0 → | | 2: 9.9 ↑ | | |
| | 3: 10.5x → | | 3: 10.3x ↘ | | |
| | 4: 10.8x ↓ | | 4: 10.2x ↖ | | |
| | 5: 10.9x ↙ | | 5: 10.4x ↗ | | |
| | 6: 10.5x ↑ | | 6: 10.3x ↑ | | |
| | 7: 9.9 → | | 7: 10.6x ← | | |
| | 8: 10.4x → | | 8: 9.9 → | | |
| | 9: 9.8 ↑ | | 9: 10.7x ← | | |
| | 10: 10.2x ↘ | | 10: 10.7x ↘ | | |
| | Series 102.3 | | Series 103.8 | | |
| | 102.3 | | 206.1 | | |
| Series 3  | 1: 10.3x ↗ | Series 4  | 1: 10.3x ↘ | | |
| | 2: 10.2x ↗ | | 2: 10.3x ← | | |
| | 3: 10.3x ↗ | | 3: 10.5x ↑ | | |
| | 4: 10.7x ↗ | | 4: 9.9 ↘ | | |
| | 5: 10.0 ↑ | | 5: 10.1 ↗ | | |
| | 6: 10.1 ↑ | | 6: 10.6x ↘ | | |
| | 7: 10.3x ↗ | | 7: 10.7x ↑ | | |
| | 8: 9.5 ↘ | | 8: 10.6x ↗ | | |
| | 9: 10.4x ↗ | | 9: 10.1 ← | | |
| | 10: 9.7 ↓ | | 10: 10.1 ↗ | | |
| | Series 101.5 | | Series 103.2 | | |
| | 307.6 | | 410.8 | | |
| Series 5  | 1: 10.6x ← | Series 6  | 1: 10.6x ← | | |
| | 2: 10.3x → | | 2: 9.8 ↓ | | |
| | 3: 10.7x ← | | 3: 10.7x → | | |
| | 4: 10.3x → | | 4: 10.2x ↓ | | |
| | 5: 10.2x ← | | 5: 10.4x ← | | |
| | 6: 10.1 → | | 6: 10.0 ← | | |
| | 7: 10.5x ← | | 7: 10.2x ↘ | | |
| | 8: 10.1 ↓ | | 8: 10.6x ↗ | | |
| | 9: 10.1 → | | 9: 10.1 ↑ | | |
| | 10: 10.0 ← | | 10: 10.5x ↑ | | |
| | Series 102.9 | | Series 103.1 | | |
| | 513.7 | | 616.8 | | |

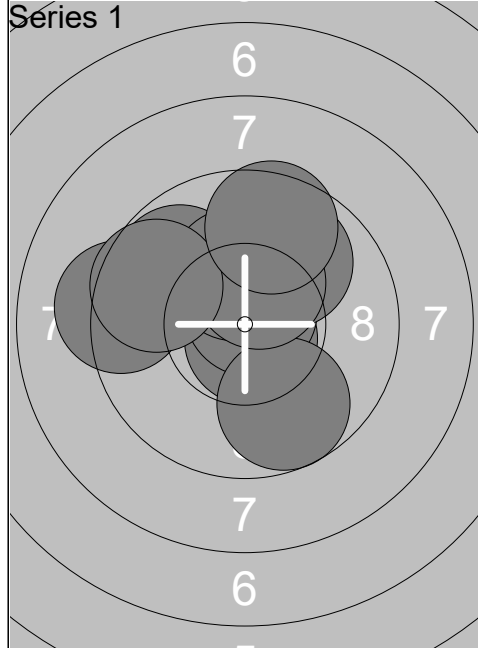

| | |
|---------------|--------------|
| 1: | 10.7x ↓ |
| 2: | 9.3 ← |
| 3: | 9.8 ↖ |
| 4: | 10.7x ↗ |
| 5: | 10.3x ↑ |
| 6: | 9.8 ↓ |
| 7: | 10.0 ↗ |
| 8: | 10.3x ↗ |
| 9: | 9.7 ↖ |
| 10: | 9.6 ↑ |
| Series | 100.2 |
| | 100.2 |

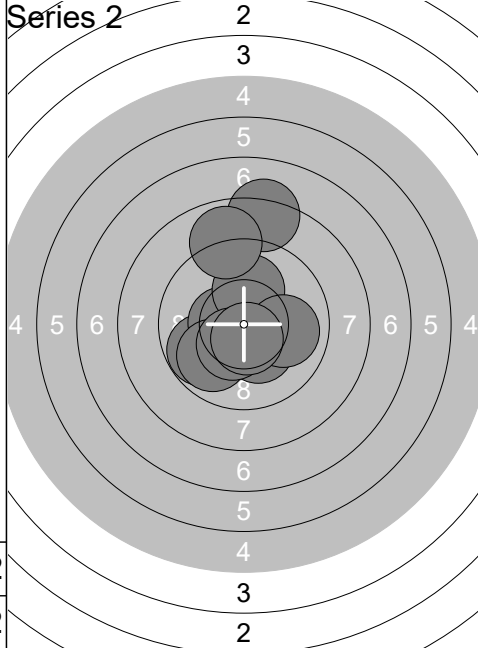

| | |
|---------------|--------------|
| 1: | 9.8 ↖ |
| 2: | 10.5x ↖ |
| 3: | 10.1 ↑ |
| 4: | 10.3x ↓ |
| 5: | 8.2 ↑ |
| 6: | 9.9 ↖ |
| 7: | 8.9 ↑ |
| 8: | 10.0 → |
| 9: | 10.4x ↖ |
| 10: | 10.6x ↓ |
| Series | 98.7 |
| | 198.9 |

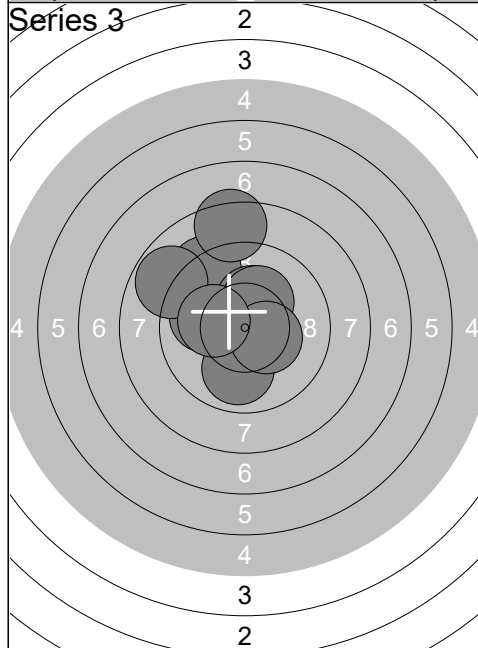

| | |
|---------------|--------------|
| 1: | 10.0 ← |
| 2: | 10.8x ↖ |
| 3: | 9.9 ↓ |
| 4: | 9.3 ↗ |
| 5: | 8.4 ↑ |
| 6: | 8.8 ↖ |
| 7: | 10.3x ↗ |
| 8: | 10.2x ↗ |
| 9: | 10.4x → |
| 10: | 10.2x ↖ |
| Series | 98.3 |
| | 297.2 |

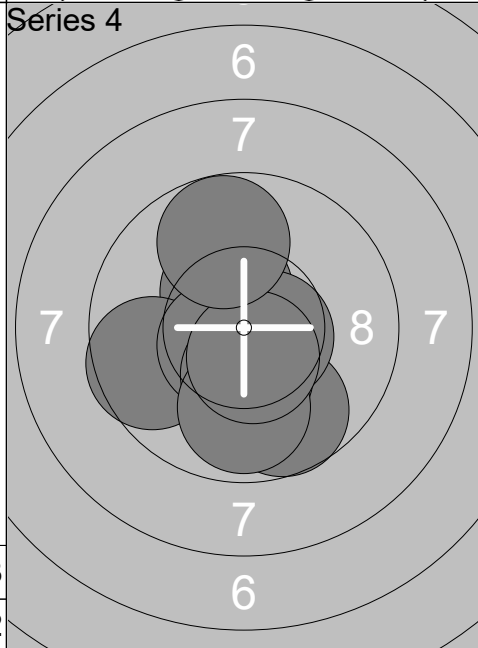

| | |
|---------------|--------------|
| 1: | 10.4x ↗ |
| 2: | 10.5x ↓ |
| 3: | 9.6 ← |
| 4: | 9.7 ↓ |
| 5: | 10.6x → |
| 6: | 10.6x ↖ |
| 7: | 10.3x ↓ |
| 8: | 9.9 ↓ |
| 9: | 10.5x ↓ |
| 10: | 9.8 ↑ |
| Series | 101.9 |
| | 399.1 |

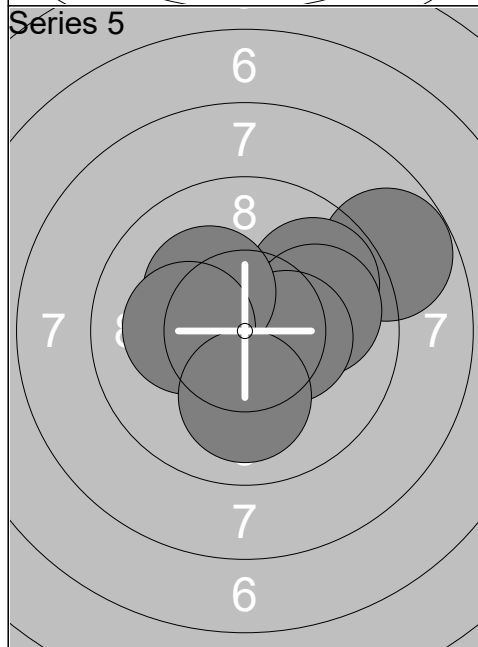

| | |
|---------------|--------------|
| 1: | 8.8 ↗ |
| 2: | 9.8 ↗ |
| 3: | 10.7x → |
| 4: | 10.6x ↓ |
| 5: | 10.6x → |
| 6: | 10.0 → |
| 7: | 10.4x → |
| 8: | 10.2x ↖ |
| 9: | 10.2x ↖ |
| 10: | 10.1 ↓ |
| Series | 101.4 |
| | 500.5 |

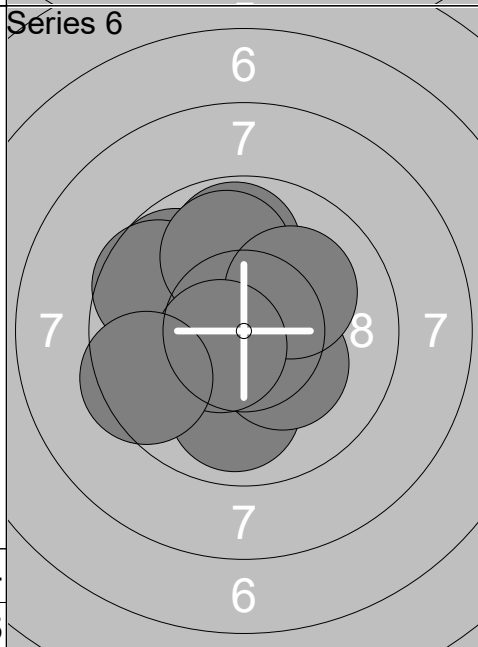

| | |
|---------------|--------------|
| 1: | 9.9 ↓ |
| 2: | 10.4x ↗ |
| 3: | 9.8 ↖ |
| 4: | 9.8 ↑ |
| 5: | 9.7 ↖ |
| 6: | 10.3x ↓ |
| 7: | 9.9 ↑ |
| 8: | 10.1 ↗ |
| 9: | 10.6x ↖ |
| 10: | 9.5 ↖ |
| Series | 100.0 |
| | 600.5 |

| Relay | Lane | Szymon Latuszek | | | |
|------------|------|-----------------------|----------|-----------------------|-------------|
| 1 | 29 | SWE | | MJ | R |
| 11.02.2026 | | Denmark Open Air 2026 | | Denmark Open Air 2026 | |
| Series 1 | | 1: 9.2 ← | Series 2 | | 1: 10.3x ⇒ |
| | | 2: 10.7x ← | | | 2: 9.8 ↓ |
| | | 3: 8.1 ↗ | | | 3: 8.5 ← |
| | | 4: 9.4 ↑ | | | 4: 9.4 ↗ |
| | | 5: 9.3 ← | | | 5: 10.0 ← |
| | | 6: 9.2 → | | | 6: 8.2 ← |
| | | 7: 9.4 ← | | | 7: 7.4 ← |
| | | 8: 10.3x ← | | | 8: 9.4 ↙ |
| | | 9: 7.6 ← | | | 9: 10.1 ↓ |
| | | 10: 7.8 ↗ | | | 10: 8.8 → |
| | | Series 91.0 | | | Series 91.9 |
| | | 91.0 | | | 182.9 |
| Series 3 | | Series 4 | | 1: 10.6x ↗ | |
| | | | | 2: 8.9 ← | 2: 10.5x ↓ |
| | | 3: 9.5 ← | | 3: 9.8 ↗ | |
| | | 4: 9.9 ← | | 4: 9.8 → | |
| | | 5: 8.1 ← | | 5: 10.0 ↑ | |
| | | 6: 10.2x ← | | 6: 9.4 ← | |
| | | 7: 9.3 ← | | 7: 9.7 → | |
| | | 8: 7.3 → | | 8: 9.5 → | |
| | | 9: 9.3 → | | 9: 8.2 ↗ | |
| | | 10: 8.1 ↗ | | 10: 5.7 ↗ | |
| | | Series 90.0 | | Series 93.2 | |
| | | 272.9 | | 366.1 | |
| Series 5 | | Series 6 | | 1: 9.7 ↙ | |
| | | | | 2: 7.2 ↗ | 2: 9.6 ↗ |
| | | 3: 10.4x ↗ | | 3: 9.7 ↗ | |
| | | 4: 9.1 ↑ | | 4: 8.6 ↗ | |
| | | 5: 8.9 ↗ | | 5: 8.5 ← | |
| | | 6: 8.1 ← | | 6: 10.6x ↗ | |
| | | 7: 9.9 ← | | 7: 10.3x ← | |
| | | 8: 8.8 ↗ | | 8: 8.9 ↗ | |
| | | 9: 8.4 ← | | 9: 9.3 → | |
| | | 10: 10.1 ↙ | | 10: 10.3x ← | |
| | | Series 91.1 | | Series 95.5 | |
| | | 457.2 | | 552.7 | |

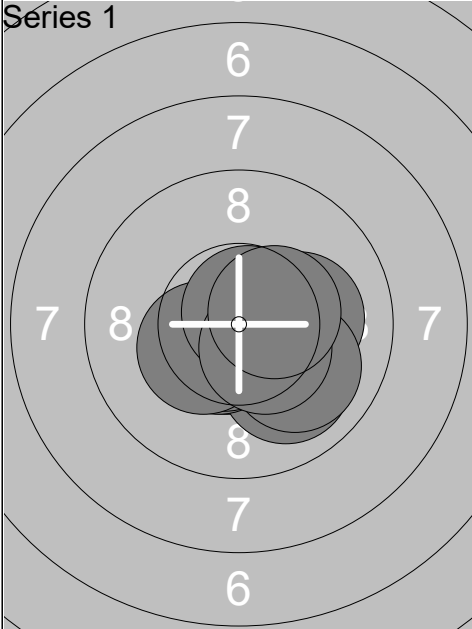
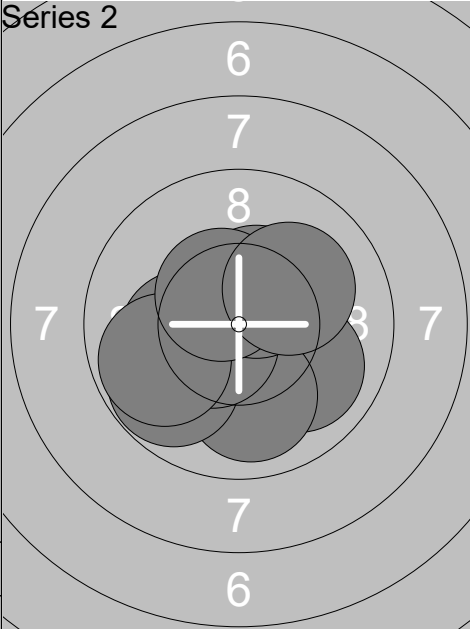
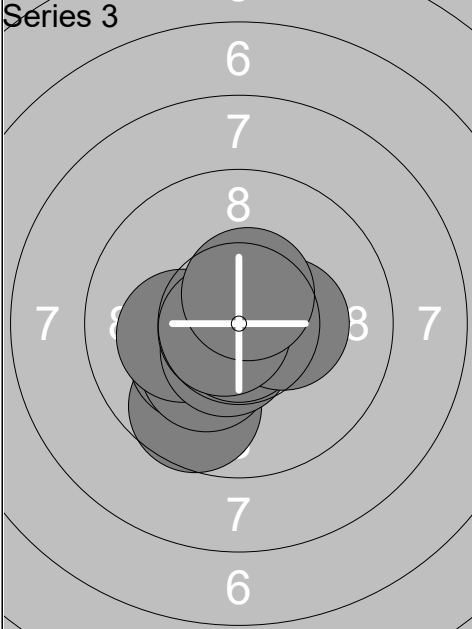
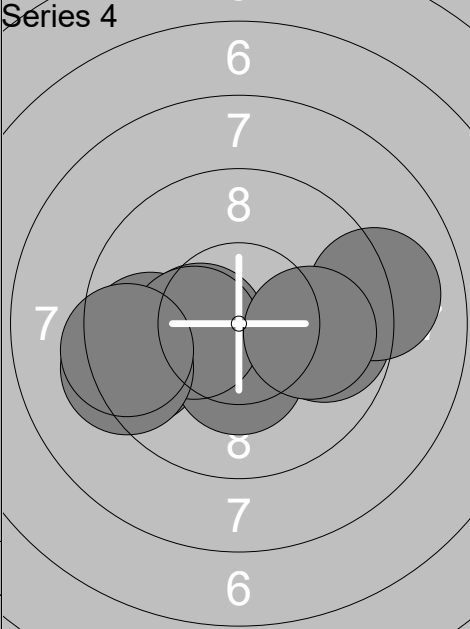
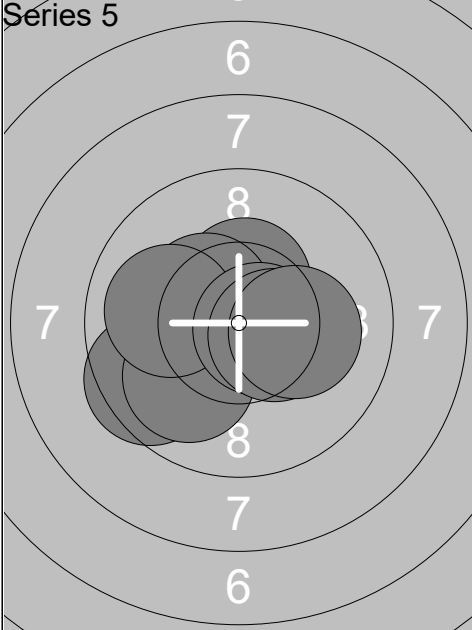
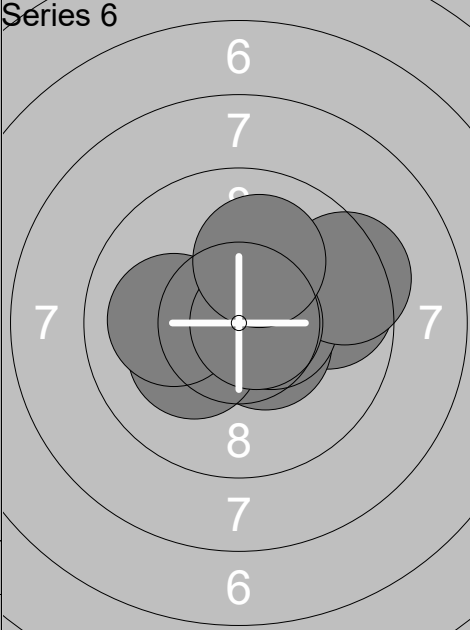
| Relay | Lane | Sander V. Sørensen | | |
|--|--------------|--|--------------|-----------------------|
| 1 | 31 | DEN | MJ | R |
| Qual Day 3 | | Denmark Open Air 2026 | | Denmark Open Air 2026 |
| 11.02.2026 | | Denmark Open Air 2026 | | Denmark Open Air 2026 |
| Series 1  | 1: 10.6x ↘ | Series 2  | 1: 10.5x ↘ | |
| | 2: 10.0 ↘ | | 2: 10.0 ↘ | |
| | 3: 10.5x ↘ | | 3: 10.0 ↓ | |
| | 4: 10.6x ↘ | | 4: 10.2x ← | |
| | 5: 10.2x → | | 5: 9.8 ↙ | |
| | 6: 10.4x ↙ | | 6: 10.5x ↙ | |
| | 7: 10.0 ↘ | | 7: 9.8 ← | |
| | 8: 10.8x ↗ | | 8: 10.5x ↗ | |
| | 9: 10.5x ↘ | | 9: 10.5x ↘ | |
| | 10: 10.4x → | | 10: 10.1 ↗ | |
| | Series 104.0 | | Series 101.9 | |
| | 104.0 | | 205.9 | |
| Series 3  | 1: 9.7 ↘ | Series 4  | 1: 9.5 ← | |
| | 2: 10.2x ↙ | | 2: 9.8 → | |
| | 3: 10.2x ↘ | | 3: 10.4x ← | |
| | 4: 10.6x ↙ | | 4: 9.7 ← | |
| | 5: 10.2x ← | | 5: 10.4x ↓ | |
| | 6: 10.6x ↘ | | 6: 10.3x ← | |
| | 7: 10.8x ↓ | | 7: 9.1 → | |
| | 8: 10.4x → | | 8: 9.3 ← | |
| | 9: 10.7x ↙ | | 9: 10.0 → | |
| | 10: 10.5x ↗ | | 10: 9.4 ← | |
| | Series 103.9 | | Series 97.9 | |
| | 309.8 | | 407.7 | |
| Series 5  | 1: 10.5x ↙ | Series 6  | 1: 10.7x → | |
| | 2: 10.4x ↗ | | 2: 9.7 → | |
| | 3: 9.5 ← | | 3: 10.5x ↘ | |
| | 4: 10.6x ↙ | | 4: 10.5x → | |
| | 5: 10.0 ↘ | | 5: 10.2x ↙ | |
| | 6: 10.4x ↙ | | 6: 10.3x ↗ | |
| | 7: 10.0 ← | | 7: 9.4 → | |
| | 8: 10.7x → | | 8: 10.1 ← | |
| | 9: 10.4x → | | 9: 10.7x → | |
| | 10: 10.2x → | | 10: 10.1 ↗ | |
| | Series 102.7 | | Series 102.2 | |
| | 510.4 | | 612.6 | |

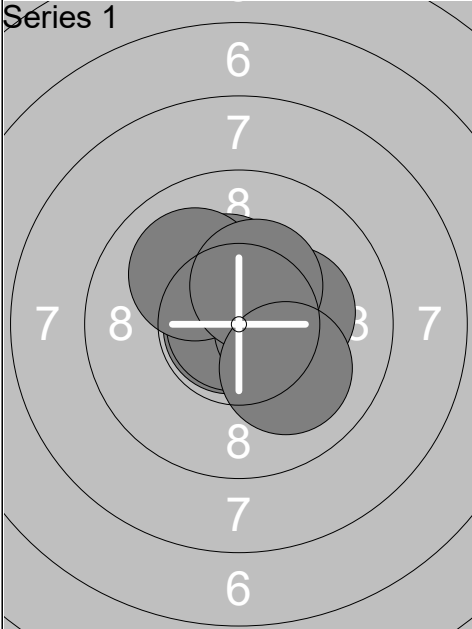
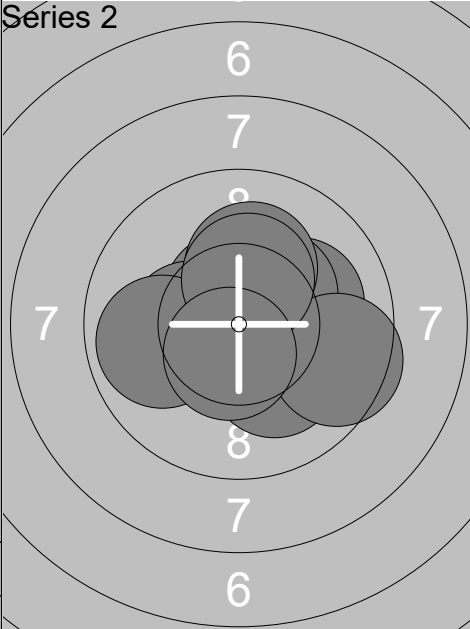
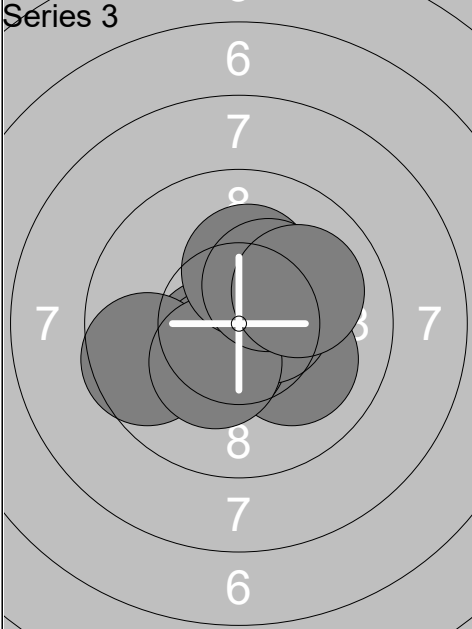
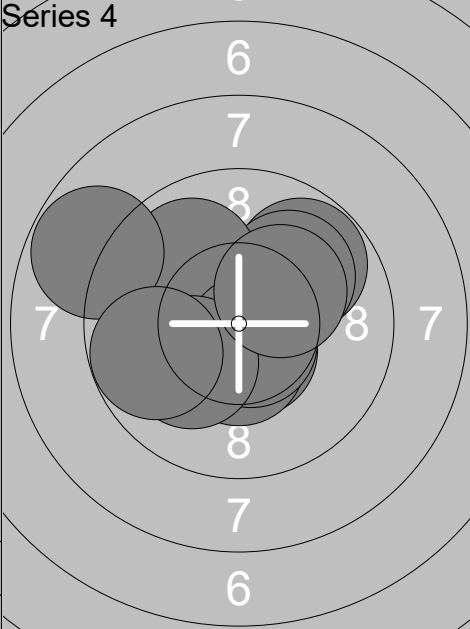
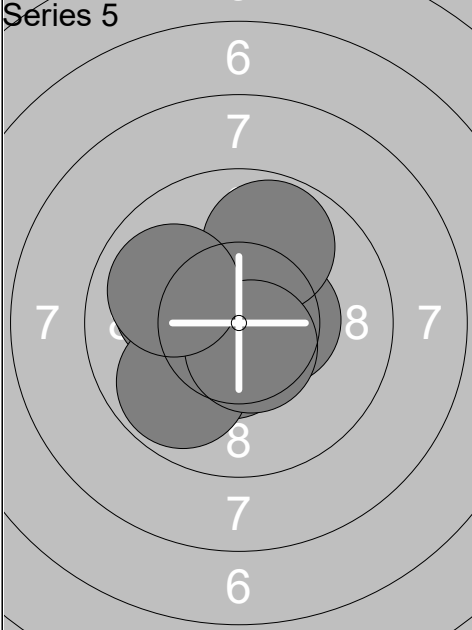
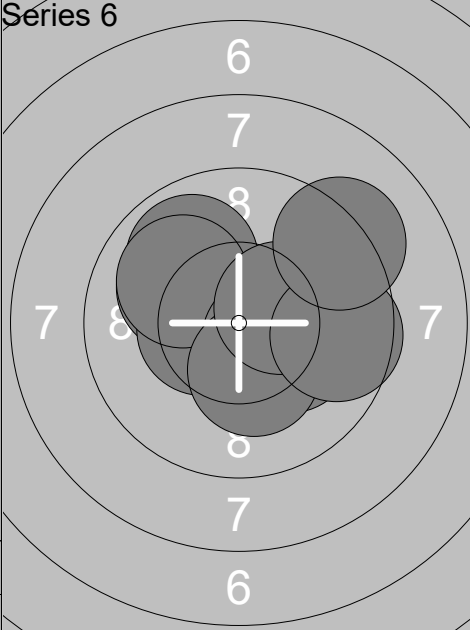
| Relay | Lane | Eirik Mahle Gisle | | |
|--|--------------|--|--------------|-----------------------|
| 1 | 32 | NOR | MJ | R |
| Qual Day 3 | | Denmark Open Air 2026 | | Denmark Open Air 2026 |
| 11.02.2026 | | | | |
| Series 1  | 1: 10.3x ↘ | Series 2  | 1: 10.2x ↘ | |
| | 2: 10.8x ← | | 2: 10.6x ↑ | |
| | 3: 10.3x ↑ | | 3: 10.3x ← | |
| | 4: 10.3x → | | 4: 10.1 → | |
| | 5: 10.9x ← | | 5: 10.4x ↗ | |
| | 6: 10.1 ↗ | | 6: 10.2x ↑ | |
| | 7: 10.4x → | | 7: 9.6 → | |
| | 8: 10.3x → | | 8: 9.9 ← | |
| | 9: 10.4x ↗ | | 9: 10.3x ↑ | |
| | 10: 10.1 ↘ | | 10: 10.5x ↓ | |
| | Series 103.9 | | Series 102.1 | |
| | 103.9 | | 206.0 | |
| Series 3  | 1: 10.1 ↘ | Series 4  | 1: 9.8 ↗ | |
| | 2: 10.5x ↙ | | 2: 10.0 ↗ | |
| | 3: 10.7x → | | 3: 10.5x ↓ | |
| | 4: 10.5x ↓ | | 4: 9.9 ↗ | |
| | 5: 10.6x → | | 5: 10.5x ↓ | |
| | 6: 9.6 ← | | 6: 8.8 ← | |
| | 7: 10.4x ↙ | | 7: 10.6x ↓ | |
| | 8: 10.2x ↑ | | 8: 10.1 ↙ | |
| | 9: 10.3x ↗ | | 9: 9.7 ← | |
| | 10: 10.0 ↗ | | 10: 10.2x ↗ | |
| | Series 102.9 | | Series 100.1 | |
| | 308.9 | | 409.0 | |
| Series 5  | 1: 10.7x ↙ | Series 6  | 1: 10.1 ↖ | |
| | 2: 10.8x ↓ | | 2: 10.5x ← | |
| | 3: 10.1 ← | | 3: 9.9 ↗ | |
| | 4: 10.5x → | | 4: 10.2x → | |
| | 5: 10.5x ↓ | | 5: 10.0 ↖ | |
| | 6: 10.5x ↑ | | 6: 10.5x → | |
| | 7: 9.8 ↙ | | 7: 10.3x ↓ | |
| | 8: 9.8 ↗ | | 8: 10.4x → | |
| | 9: 10.6x ↓ | | 9: 9.6 → | |
| | 10: 10.0 ↖ | | 10: 9.2 ↗ | |
| | Series 103.3 | | Series 100.7 | |
| | 512.3 | | 613.0 | |

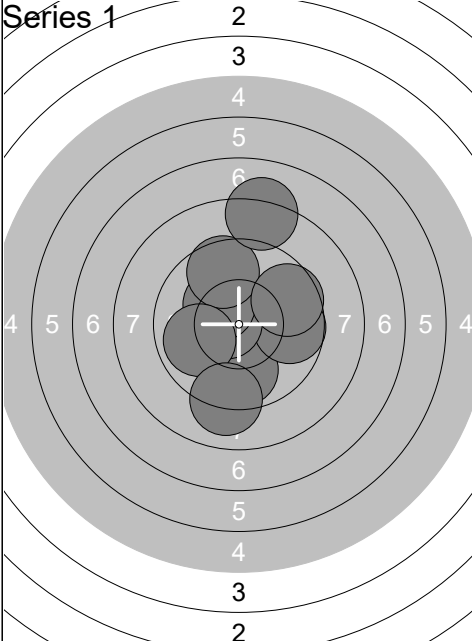
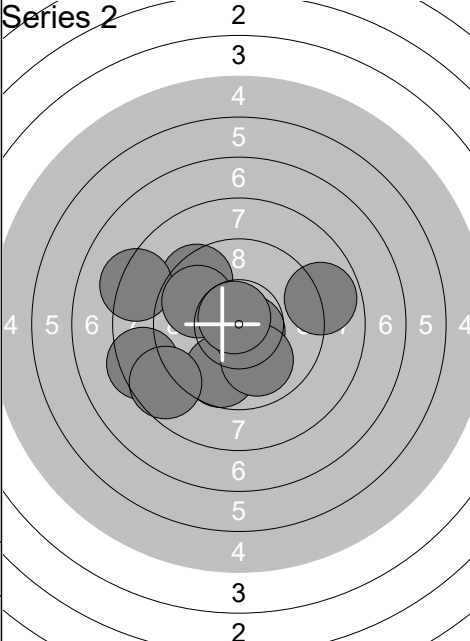
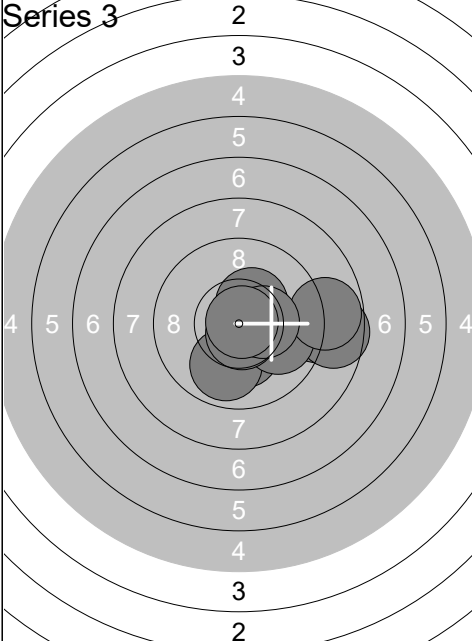
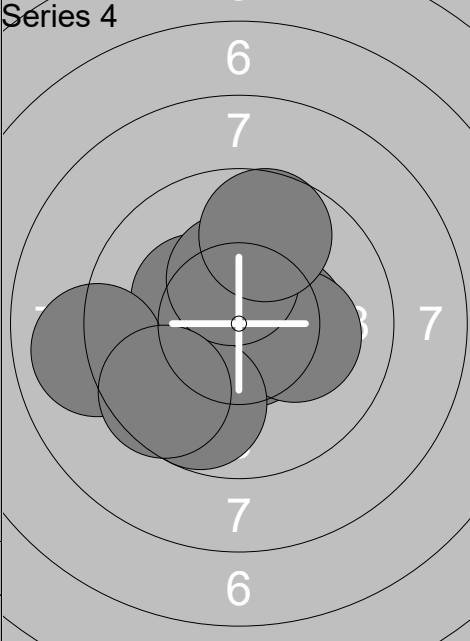
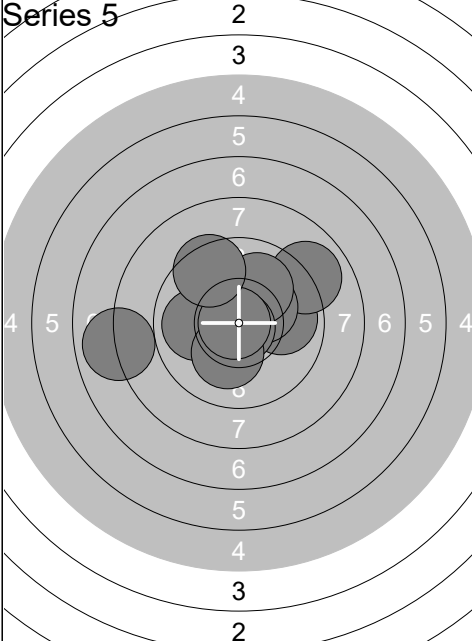
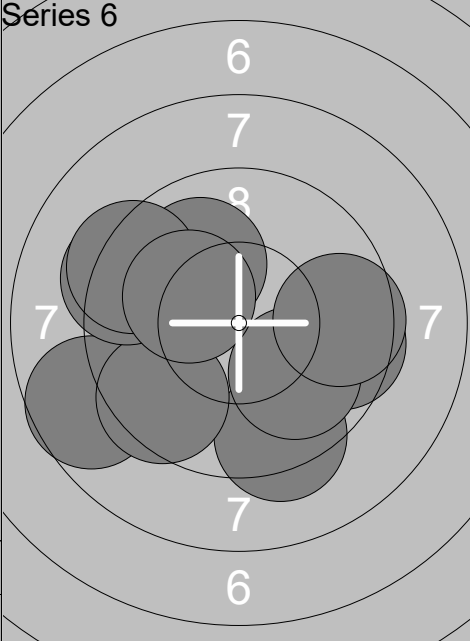
| Relay | Lane | Mikael Rutgersson | | | |
|------------|--|-----------------------|----------|--|--------------|
| 1 | 33 | SWE | MJ | R | |
| Qual Day 3 | | Denmark Open Air 2026 | | Denmark Open Air 2026 | |
| 11.02.2026 | | | | | |
| Series 1 |  | 1: 10.2x → | Series 2 |  | 1: 9.5 ↗ |
| | | 2: 9.8 ↓ | | | 2: 8.2 ↖ |
| | | 3: 9.7 → | | | 3: 9.8 ↗ |
| | | 4: 10.6x ← | | | 4: 9.7 ↓ |
| | | 5: 10.3x ↗ | | | 5: 10.7x ↘ |
| | | 6: 9.6 ↑ | | | 6: 8.4 ↖ |
| | | 7: 9.9 ← | | | 7: 10.0 ↓ |
| | | 8: 8.2 ↑ | | | 8: 8.6 ↖ |
| | | 9: 9.1 ↓ | | | 9: 10.7x ↗ |
| | | 10: 9.6 ↗ | | | 10: 8.9 → |
| | | Series 97.0 | | | Series 94.5 |
| | | 97.0 | | | 191.5 |
| Series 3 |  | 1: 9.0 → | Series 4 |  | 1: 10.3x ↖ |
| | | 2: 10.2x ↓ | | | 2: 10.8x ↘ |
| | | 3: 8.6 → | | | 3: 10.4x → |
| | | 4: 10.4x ↗ | | | 4: 10.7x ↓ |
| | | 5: 9.9 ↓ | | | 5: 10.2x → |
| | | 6: 9.9 → | | | 6: 9.7 ↓ |
| | | 7: 8.8 → | | | 7: 9.0 ← |
| | | 8: 10.7x ↓ | | | 8: 10.3x ↑ |
| | | 9: 10.3x → | | | 9: 9.6 ↖ |
| | | 10: 10.9x ↗ | | | 10: 9.7 ↑ |
| | | Series 98.7 | | | Series 100.7 |
| | | 290.2 | | | 390.9 |
| Series 5 |  | 1: 10.0 ← | Series 6 |  | 1: 9.5 → |
| | | 2: 9.9 → | | | 2: 8.7 ↖ |
| | | 3: 9.0 ↗ | | | 3: 9.3 ↓ |
| | | 4: 10.3x ↗ | | | 4: 9.5 ↖ |
| | | 5: 10.0 ↑ | | | 5: 10.0 ↗ |
| | | 6: 8.0 ← | | | 6: 9.3 ↖ |
| | | 7: 10.8x ↓ | | | 7: 9.9 ↓ |
| | | 8: 10.2x ↓ | | | 8: 9.6 → |
| | | 9: 10.8x ← | | | 9: 9.3 ↖ |
| | | 10: 9.5 ↗ | | | 10: 10.2x ↖ |
| | | Series 98.5 | | | Series 95.3 |
| | | 489.4 | | | 584.7 |

| Relay | Lane | Brandon Lu | | | |
|---------------------|---------------------|-----------------------|------------|-----------------------|---|
| 1 | 34 | CAN | | MJ | R |
| Qual Day 3 | | Denmark Open Air 2026 | | Denmark Open Air 2026 | |
| 11.02.2026 | | Denmark Open Air 2026 | | Denmark Open Air 2026 | |
| Series 1 | 1: 10.2x → | Series 2 | 1: 10.3x ↗ | | |
| | 2: 10.5x ↓ | | 2: 10.0 ↘ | | |
| | 3: 9.6 ↑ | | 3: 10.6x ↗ | | |
| | 4: 10.1 ↘ | | 4: 10.7x ↗ | | |
| | 5: 9.7 ↗ | | 5: 10.4x ↑ | | |
| | 6: 10.8x ← | | 6: 9.9 ↑ | | |
| | 7: 10.6x ← | | 7: 9.6 ← | | |
| | 8: 9.7 → | | 8: 9.5 ↗ | | |
| | 9: 9.3 → | | 9: 9.3 → | | |
| | 10: 9.7 → | | 10: 10.1 ← | | |
| | Series 100.2 | Series 100.4 | | | |
| | 100.2 | 200.6 | | | |
| Series 3 | 1: 10.7x ← | Series 4 | 1: 10.1 ← | | |
| | 2: 9.9 ↘ | | 2: 10.0 ← | | |
| | 3: 10.3x ↓ | | 3: 10.4x ← | | |
| | 4: 10.2x ← | | 4: 9.3 → | | |
| | 5: 9.5 ↘ | | 5: 7.9 → | | |
| | 6: 9.4 → | | 6: 10.2x ↘ | | |
| | 7: 10.2x → | | 7: 9.4 ↗ | | |
| | 8: 10.1 → | | 8: 9.2 → | | |
| | 9: 9.8 ↓ | | 9: 10.4x → | | |
| | 10: 9.3 ↗ | | 10: 9.7 ↘ | | |
| | Series 99.4 | Series 96.6 | | | |
| | 300.0 | 396.6 | | | |
| Series 5 | 1: 9.4 ↗ | Series 6 | 1: 9.7 → | | |
| | 2: 9.7 → | | 2: 9.0 → | | |
| | 3: 9.2 → | | 3: 10.2x → | | |
| | 4: 9.7 → | | 4: 9.7 ↘ | | |
| | 5: 9.5 ↘ | | 5: 9.6 ↘ | | |
| | 6: 8.8 ↘ | | 6: 10.5x → | | |
| | 7: 9.7 ← | | 7: 9.7 ← | | |
| | 8: 10.3x → | | 8: 10.4x ← | | |
| | 9: 9.6 ↘ | | 9: 10.0 ↓ | | |
| | 10: 9.9 → | | 10: 10.0 → | | |
| | Series 95.8 | Series 98.8 | | | |
| | 492.4 | 591.2 | | | |

| Relay | Lane | Rasmus Nissen | | |
|---------------------|--------------|-----------------------|--------------|-----------------------|
| 1 | 35 | DEN | MJ | R |
| Qual Day 3 | | Denmark Open Air 2026 | | Denmark Open Air 2026 |
| 11.02.2026 | | Denmark Open Air 2026 | | Denmark Open Air 2026 |
| Series 1 | 1: 9.4 ↖ | Series 2 | 1: 9.6 ← | |
| | 2: 9.4 ← | | 2: 10.1 ↑ | |
| | 3: 10.6x ↖ | | 3: 9.8 ↘ | |
| 4: 10.1 ↘ | 4: 10.3x ↓ | 4: 10.2x ↑ | 4: 10.0 ↖ | |
| 5: 10.2x ← | 5: 10.0 ↖ | 5: 10.4x → | 5: 10.0 ↑ | |
| 6: 9.7 ↑ | 6: 10.0 ↑ | 6: 10.3x → | 6: 10.0 ↖ | |
| 7: 10.1 ↗ | 7: 10.4x ↗ | 7: 10.0 ↑ | 7: 10.3x → | |
| 8: 9.8 ↗ | 8: 10.3x ↑ | 8: 10.0 ↖ | 8: 10.3x ↑ | |
| 9: 10.0 ↑ | 9: 10.3x ↑ | 9: 10.0 ↖ | 9: 10.3x ↑ | |
| 10: 10.4x ↖ | 10: 10.3x ↑ | 10: 10.3x ↑ | 10: 10.3x ↑ | |
| Series 99.7 | Series 101.0 | Series 200.7 | Series 101.0 | |
| 99.7 | 200.7 | 200.7 | 101.0 | |
| Series 3 | 1: 9.3 ↗ | Series 4 | 1: 9.8 ↑ | |
| | 2: 10.6x ↘ | | 2: 10.1 ↑ | |
| | 3: 8.3 → | | 3: 9.8 ← | |
| 4: 10.2x ← | 4: 10.3x ↗ | 4: 9.4 ↖ | 4: 10.0 ← | |
| 5: 9.5 ↑ | 5: 9.4 ↖ | 5: 10.1 ↓ | 5: 10.8x ↑ | |
| 6: 10.0 ↖ | 6: 10.0 ← | 6: 10.8x ↑ | 6: 10.5x ↖ | |
| 7: 10.4x ↘ | 7: 10.1 ↓ | 7: 10.7x ↖ | 7: 10.7x ↘ | |
| 8: 10.7x ↖ | 8: 10.8x ↑ | 8: 10.7x ↘ | 8: 10.7x ↘ | |
| 9: 9.8 ↖ | 9: 10.5x ↖ | 9: 10.7x ↘ | 9: 10.7x ↘ | |
| 10: 9.3 ↖ | 10: 10.7x ↘ | 10: 10.7x ↘ | 10: 10.7x ↘ | |
| Series 98.1 | Series 101.5 | Series 400.3 | Series 101.5 | |
| 298.8 | 400.3 | 400.3 | 101.5 | |
| Series 5 | 1: 10.1 ↑ | Series 6 | 1: 9.8 ↘ | |
| | 2: 9.8 ↘ | | 2: 10.0 ← | |
| | 3: 8.1 ↖ | | 3: 7.4 → | |
| 4: 10.4x ↗ | 4: 10.0 → | 4: 9.9 ↗ | 4: 10.8x ↘ | |
| 5: 10.5x ← | 5: 9.9 ↗ | 5: 10.0 ↓ | 5: 10.4x ↓ | |
| 6: 10.0 → | 6: 10.8x ↘ | 6: 10.0 ↓ | 6: 10.7x → | |
| 7: 10.5x ↑ | 7: 10.0 ↓ | 7: 10.4x ↓ | 7: 10.6x ↑ | |
| 8: 9.9 → | 8: 10.4x ↓ | 8: 10.7x → | 8: 10.6x ↑ | |
| 9: 10.0 ↓ | 9: 10.7x → | 9: 10.6x ↑ | 9: 10.6x ↑ | |
| 10: 9.4 ↑ | 10: 10.6x ↑ | 10: 10.6x ↑ | 10: 10.6x ↑ | |
| Series 98.7 | Series 99.6 | Series 598.6 | Series 99.6 | |
| 499.0 | 598.6 | 598.6 | 99.6 | |

| Relay | Lane | Karl Pantzar | | |
|---------------------|---------------------|-----------------------|-------------|-----------------------|
| 1 | 37 | SWE | MJ | R |
| Qual Day 3 | | Denmark Open Air 2026 | | Denmark Open Air 2026 |
| 11.02.2026 | | | | |
| Series 1 | 1: 10.3x → | Series 2 | 1: 8.7 ← | |
| | 2: 10.8x ← | | 2: 9.9 ↖ | |
| | 3: 10.1 ↘ | | 3: 10.2x → | |
| | 4: 10.5x ↗ | | 4: 10.0 ← | |
| | 5: 10.2x → | | 5: 10.5x ← | |
| | 6: 10.6x ↗ | | 6: 9.4 ↗ | |
| | 7: 9.5 ← | | 7: 10.2x ↖ | |
| | 8: 10.5x → | | 8: 10.7x ↗ | |
| | 9: 9.9 ↘ | | 9: 10.4x ↖ | |
| | 10: 9.6 ↖ | | 10: 10.8x ↘ | |
| | Series 102.0 | Series 100.8 | | |
| | 102.0 | 202.8 | | |
| Series 3 | 1: 10.7x ↖ | Series 4 | 1: 9.8 ↗ | |
| | 2: 10.7x ↓ | | 2: 10.2x ↖ | |
| | 3: 10.5x ↖ | | 3: 10.3x ↖ | |
| | 4: 9.8 ↓ | | 4: 10.4x ↙ | |
| | 5: 10.1 ↘ | | 5: 10.0 → | |
| | 6: 10.3x ↖ | | 6: 10.7x ↓ | |
| | 7: 9.9 ↗ | | 7: 9.9 → | |
| | 8: 10.3x ↗ | | 8: 10.4x ↗ | |
| | 9: 9.6 ↖ | | 9: 10.4x ↘ | |
| | 10: 9.0 ← | | 10: 10.2x ↖ | |
| | Series 100.9 | Series 102.3 | | |
| | 303.7 | 406.0 | | |
| Series 5 | 1: 10.3x → | Series 6 | 1: 9.8 → | |
| | 2: 10.0 ↗ | | 2: 10.5x ↓ | |
| | 3: 10.3x ↗ | | 3: 10.3x ↗ | |
| | 4: 9.9 ↗ | | 4: 9.8 ↗ | |
| | 5: 9.7 ↗ | | 5: 10.0 ↗ | |
| | 6: 9.9 ← | | 6: 10.1 → | |
| | 7: 10.2x ↓ | | 7: 9.8 ↘ | |
| | 8: 9.4 ← | | 8: 10.5x ↓ | |
| | 9: 10.6x ↓ | | 9: 9.1 → | |
| | 10: 9.9 ← | | 10: 10.4x ↓ | |
| | Series 100.2 | Series 100.3 | | |
| | 506.2 | 606.5 | | |