

Relay	Lane	Daniel Binder		
1	2	DEN	M	R
Qual Day 3		Denmark Open Air 2026		Denmark Open Air 2026
11.02.2026				
Series 1 	1: 10.3x →	Series 2 	1: 9.2 →	
	2: 10.2x →		2: 10.3x ↑	
	3: 7.6 ←		3: 10.2x ↖	
	4: 9.0 →		4: 10.5x ↙	
	5: 9.5 ←		5: 10.6x ↓	
	6: 9.4 →		6: 10.1 ↗	
	7: 10.3x ↑		7: 8.7 ←	
	8: 10.1 ←		8: 10.1 →	
	9: 9.9 ↖		9: 9.7 ↙	
	10: 10.6x ↗		10: 8.5 →	
	Series 96.9		Series 97.9	
	96.9		194.8	
Series 3 	1: 10.1 →	Series 4 	1: 9.5 →	
	2: 10.6x →		2: 9.1 ←	
	3: 9.9 ↙		3: 10.8x ←	
	4: 10.7x →		4: 10.1 →	
	5: 9.2 →		5: 10.4x ↘	
	6: 10.4x →		6: 9.9 ←	
	7: 10.5x ↗		7: 10.6x ↖	
	8: 10.4x →		8: 8.1 ←	
	9: 10.4x ↙		9: 9.1 ↗	
	10: 9.5 →		10: 10.2x →	
	Series 101.7		Series 97.8	
	296.5		394.3	
Series 5 	1: 9.0 ←	Series 6 	1: 9.2 ↖	
	2: 10.0 ←		2: 10.9x ←	
	3: 7.4 →		3: 9.5 ↓	
	4: 10.1 ↘		4: 9.6 →	
	5: 7.0 →		5: 10.2x ↙	
	6: 9.2 ←		6: 9.4 ↘	
	7: 10.1 ←		7: 9.5 →	
	8: 9.9 ←		8: 10.6x ↘	
	9: 10.7x ↘		9: 9.4 →	
	10: 9.9 ↓		10: 10.3x →	
	Series 93.3		Series 98.6	
	487.6		586.2	

Relay	Lane	Jacob Kuylser		
Qual Day 3		SWE	M	R
11.02.2026		Denmark Open Air 2026	Denmark Open Air 2026	
Series 1 	1: 10.3x ↑	Series 2 	1: 10.6x ↙	
	2: 9.6 ↙		2: 10.3x ↑	
	3: 10.8x ↑		3: 10.1 ↖	
	4: 10.2x ↘		4: 10.1 ↑	
	5: 10.1 ↘		5: 10.3x →	
	6: 10.8x →		6: 9.7 →	
	7: 10.5x ↑		7: 10.8x ↑	
	8: 10.5x ↑		8: 9.0 →	
	9: 10.2x ↖		9: 10.1 ↖	
	10: 10.5x ↖		10: 9.6 ↗	
	Series 103.5		Series 100.6	
	103.5		204.1	
Series 3 	1: 9.9 ↗	Series 4 	1: 10.3x ↘	
	2: 9.6 ↗		2: 10.6x →	
	3: 9.9 ↑		3: 10.7x ↖	
	4: 9.8 ↘		4: 10.2x ↖	
	5: 10.5x ↗		5: 10.3x ↖	
	6: 10.1 ↖		6: 10.3x ↖	
	7: 10.8x ↑		7: 10.1 →	
	8: 10.0 ↘		8: 10.2x →	
	9: 10.1 →		9: 10.6x ↑	
	10: 10.2x ↖		10: 10.9x ↑	
	Series 100.9		Series 104.2	
	305.0		409.2	
Series 5 	1: 9.6 →	Series 6 	1: 10.5x →	
	2: 9.5 ↗		2: 10.4x →	
	3: 10.3x ↗		3: 10.1 →	
	4: 10.4x ↑		4: 10.6x ↗	
	5: 10.6x ↘		5: 10.3x →	
	6: 10.6x ↘		6: 9.8 →	
	7: 9.0 ↖		7: 10.1 ↘	
	8: 9.9 ↘		8: 10.4x ↖	
	9: 10.2x →		9: 10.7x ↗	
	10: 10.6x ↙		10: 10.9x ↖	
	Series 100.7		Series 103.8	
	509.9		613.7	

Relay	Lane	Martin Black Jørgensen		
1	5			
Qual Day 3		DEN		M R
11.02.2026		Denmark Open Air 2026		Denmark Open Air 2026
Series 1 	1: 10.6x ↑	Series 2 	1: 10.2x ↗	
	2: 10.0 ↘		2: 10.8x ↖	
	3: 10.1 ↓		3: 10.4x ↓	
	4: 10.8x →		4: 10.5x ↖	
	5: 10.3x ↙		5: 10.4x ↗	
	6: 9.3 ↘		6: 10.4x ↓	
	7: 10.4x →		7: 10.1 ↓	
	8: 10.5x ↖		8: 10.8x ↗	
	9: 10.4x ↓		9: 10.4x ↖	
	10: 10.5x ↖		10: 10.2x ↑	
	Series 102.9	Series 104.2		
	102.9	207.1		
Series 3 	1: 10.2x →	Series 4 	1: 10.7x ↓	
	2: 10.6x ↑		2: 10.5x ↗	
	3: 10.7x →		3: 9.1 ↖	
	4: 10.3x →		4: 9.9 ↖	
	5: 10.9x ↙		5: 9.7 ↗	
	6: 10.0 ←		6: 10.3x ↑	
	7: 10.6x ↗		7: 10.4x ↓	
	8: 10.6x →		8: 10.7x ↗	
	9: 10.6x ↑		9: 10.7x ↖	
	10: 9.6 →		10: 10.2x →	
	Series 104.1	Series 102.2		
	311.2	413.4		
Series 5 	1: 10.3x ↓	Series 6 	1: 9.9 ↓	
	2: 10.5x →		2: 10.7x ↖	
	3: 10.3x →		3: 10.4x ↗	
	4: 10.3x ↖		4: 10.8x ↓	
	5: 10.6x ↙		5: 10.9x ↙	
	6: 9.9 ↘		6: 10.9x →	
	7: 10.6x ↖		7: 10.4x ↓	
	8: 10.0 ↓		8: 10.5x →	
	9: 9.9 ↗		9: 10.6x ↖	
	10: 10.4x ↑		10: 10.2x ↓	
	Series 102.8	Series 105.3		
	516.2	621.5		

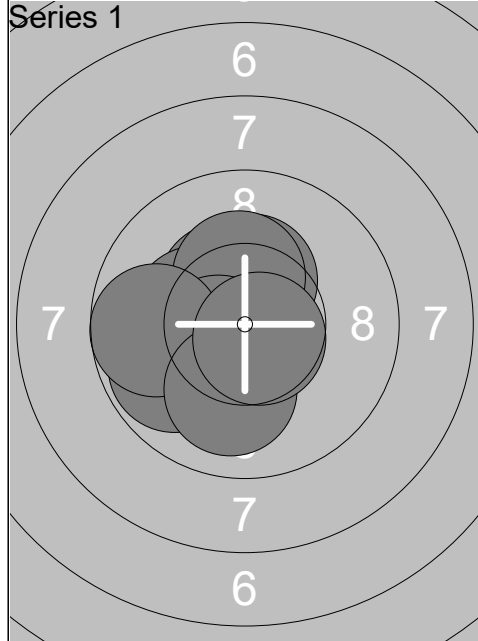

1:	10.4x ↗
2:	10.5x ↖
3:	10.3x ↙
4:	10.4x ↑
5:	10.3x ↑
6:	10.5x ↖
7:	9.8 ←
8:	9.8 ←
9:	10.0 ↓
10:	10.7x ↘
Series	102.7
	102.7

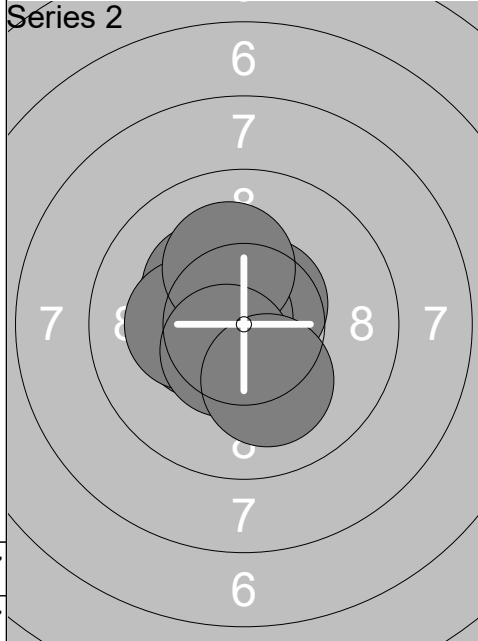

1:	10.5x ↓
2:	10.6x ↗
3:	10.4x ↙
4:	10.3x ↙
5:	10.7x ↙
6:	10.3x ↖
7:	10.2x ↙
8:	10.2x ↑
9:	10.5x ↘
10:	10.1 ↓
Series	103.8
	206.5

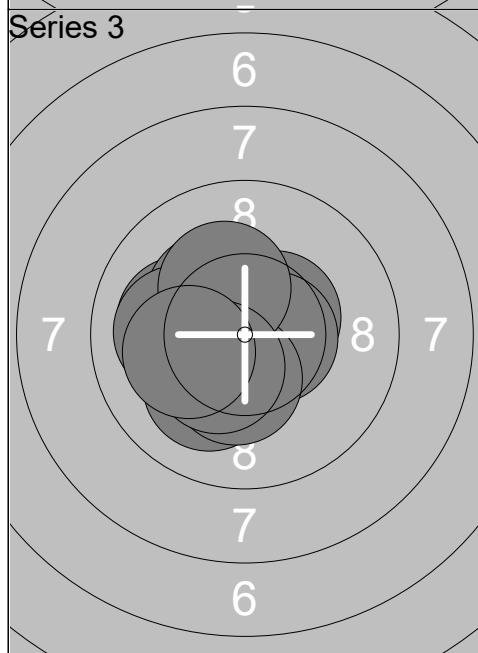

1:	10.1 ←
2:	10.5x ↗
3:	10.6x →
4:	10.1 ↓
5:	10.3x ↓
6:	10.3x ↖
7:	10.1 ←
8:	10.3x ↖
9:	10.4x ↘
10:	10.2x ↙
Series	102.9
	309.4

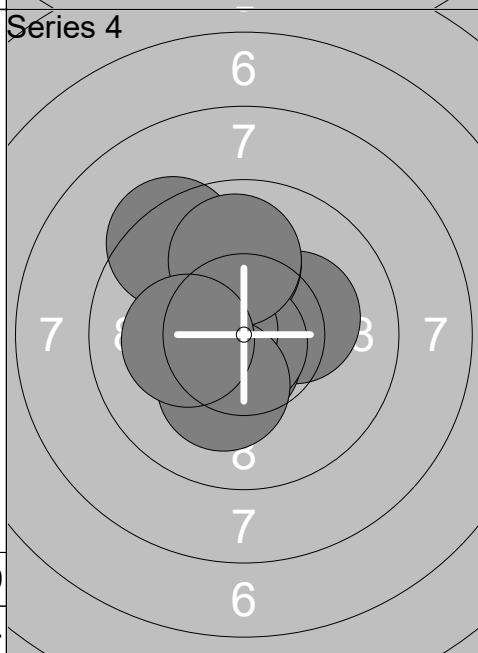

1:	10.3x ↙
2:	10.2x →
3:	10.0 ↑
4:	10.6x ↓
5:	9.4 ↖
6:	10.8x ↓
7:	10.5x ↙
8:	10.2x ↓
9:	10.0 ↑
10:	10.2x ↙
Series	102.2
	411.6

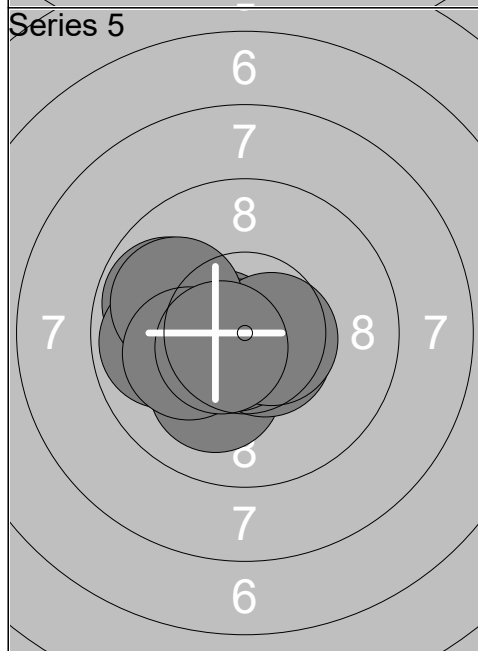

1:	9.8 ←
2:	10.6x ↙
3:	10.1 ↓
4:	9.9 ←
5:	10.6x ↘
6:	10.7x ↘
7:	10.6x →
8:	9.9 ←
9:	10.2x ↙
10:	10.6x ↙
Series	103.0
	514.6

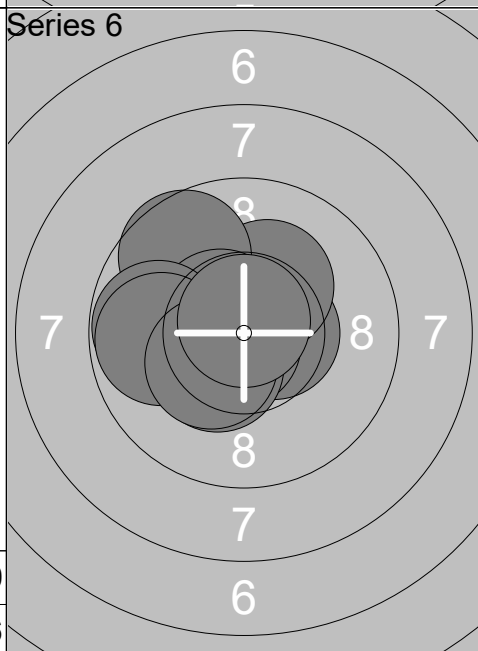

1:	10.6x →
2:	10.8x ↙
3:	10.2x ↗
4:	9.7 ↖
5:	10.5x ↖
6:	10.4x ↙
7:	9.8 ←
8:	9.8 ←
9:	10.4x ↙
10:	10.8x ↑
Series	103.0
	617.6

Relay	Lane	Isak Gurrik		
1	8	NOR	M	R
Qual Day 3		Denmark Open Air 2026		Denmark Open Air 2026
11.02.2026		Denmark Open Air 2026		Denmark Open Air 2026
Series 1 	1: 10.6x ←	Series 2 	1: 9.9 →	
	2: 10.6x ↗		2: 10.9x ↑	
	3: 10.7x ↗		3: 10.0 →	
	4: 10.4x ↓		4: 10.0 ↖	
	5: 10.3x ↘		5: 10.8x ↑	
	6: 10.5x ←		6: 10.3x ↖	
	7: 10.1 ↗		7: 10.4x ↑	
	8: 10.1 →		8: 10.2x ↘	
	9: 10.4x ↗		9: 10.6x ↘	
	10: 10.0 →		10: 10.6x ←	
	Series 103.7		Series 103.7	
	103.7		207.4	
Series 3 	1: 9.2 →	Series 4 	1: 10.1 ↓	
	2: 9.9 →		2: 10.6x ←	
	3: 10.2x ↓		3: 10.1 ←	
	4: 10.7x ↗		4: 9.6 →	
	5: 10.2x ↑		5: 10.2x ↗	
	6: 10.5x ↘		6: 10.4x ↑	
	7: 10.9x ↓		7: 10.2x ↗	
	8: 10.5x ↑		8: 9.8 ↙	
	9: 10.4x ↓		9: 9.7 →	
	10: 10.3x ↙		10: 10.0 →	
	Series 102.8		Series 100.7	
	310.2		410.9	
Series 5 	1: 9.9 ↖	Series 6 	1: 9.8 ↖	
	2: 10.2x ↑		2: 10.5x ←	
	3: 10.4x ↓		3: 10.5x ↖	
	4: 10.3x ←		4: 10.9x ↑	
	5: 10.8x ←		5: 10.1 ←	
	6: 10.6x ←		6: 10.6x ↑	
	7: 10.6x →		7: 10.6x ↘	
	8: 9.9 ↙		8: 10.1 ↓	
	9: 10.5x ↘		9: 10.7x ↑	
	10: 10.7x →		10: 10.5x ↓	
	Series 103.9		Series 104.3	
	514.8		619.1	

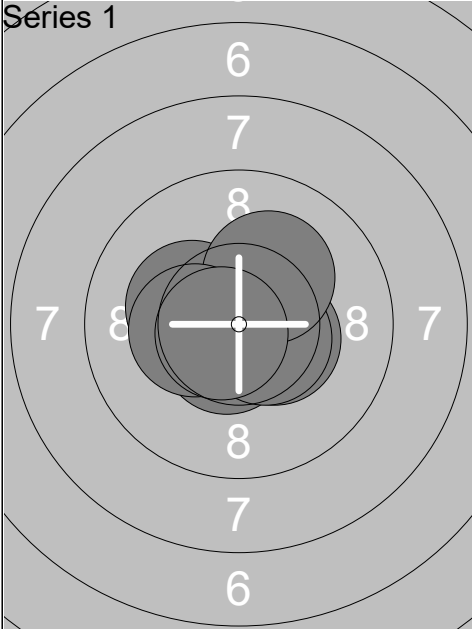
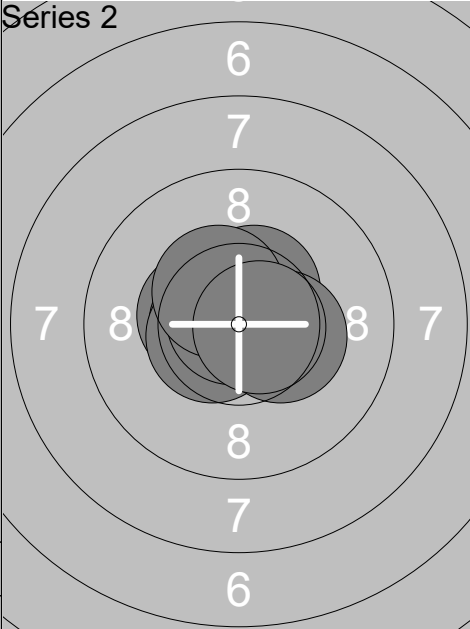
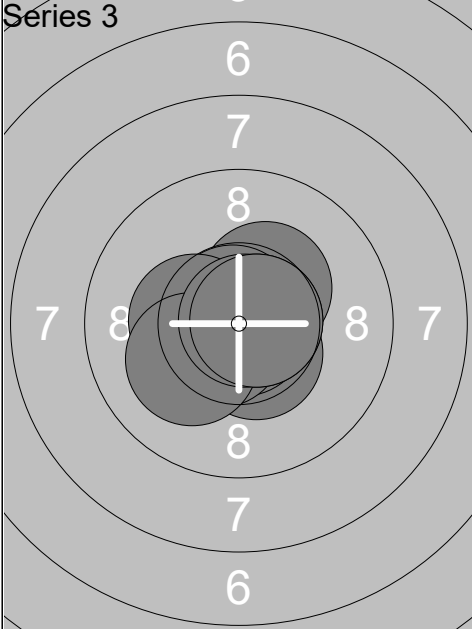
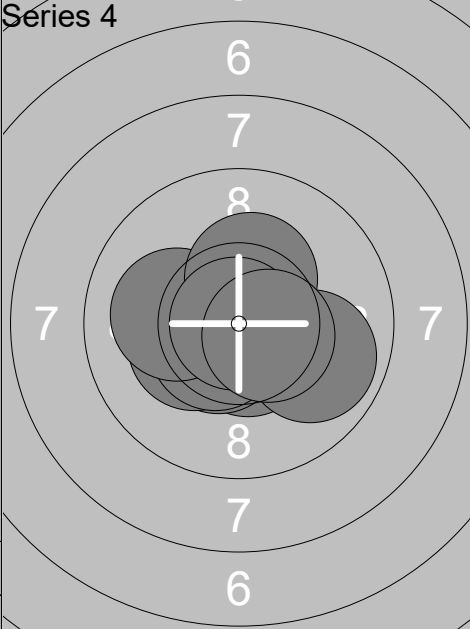
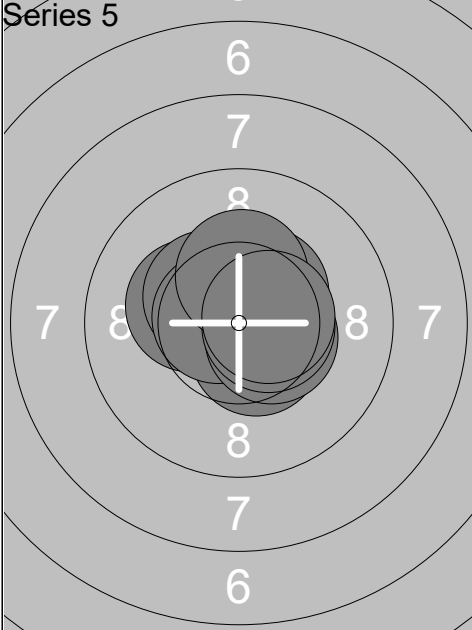
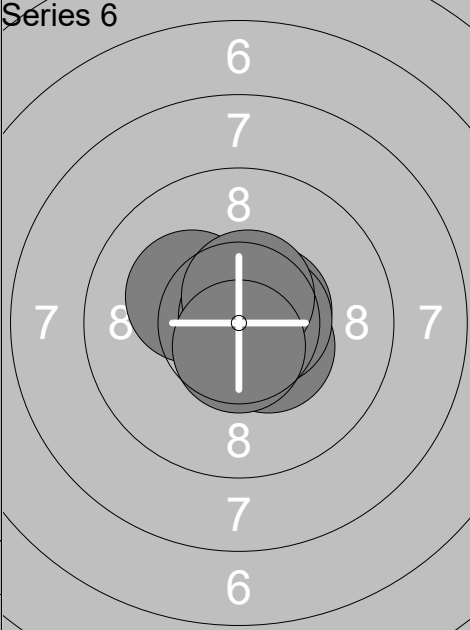
Relay	Lane	Participant Name			
1	10	Marcus Madsen			
Qual Day 3		SWE	M	R	
11.02.2026		Denmark Open Air 2026		Denmark Open Air 2026	
Series 1				Series 2 	
		1: 10.7x ← 2: 10.7x ← 3: 10.4x → 4: 10.6x ↙ 5: 10.3x ← 6: 10.6x ↘ 7: 10.5x → 8: 10.2x ↗ 9: 10.3x ← 10: 10.7x ←		1: 10.5x ← 2: 10.6x ← 3: 10.7x ↗ 4: 10.5x ↗ 5: 10.9x → 6: 10.5x ← 7: 10.4x → 8: 10.9x ↖ 9: 10.4x ↖ 10: 10.7x →	
		Series 105.0		Series 106.1	
		105.0		211.1	
Series 3				Series 4 	
		1: 10.4x ↗ 2: 10.5x ↘ 3: 10.9x ↘ 4: 10.6x ↙ 5: 10.8x ↖ 6: 10.4x ← 7: 10.7x → 8: 10.2x ↙ 9: 10.9x ↗ 10: 10.7x →		1: 10.8x ↗ 2: 10.6x ↘ 3: 10.5x ↙ 4: 10.3x ← 5: 9.9 → 6: 10.5x ↙ 7: 10.1 ← 8: 10.3x ↗ 9: 10.9x ← 10: 10.5x →	
		Series 106.1		Series 104.4	
		317.2		421.6	
Series 5				Series 6 	
		1: 10.4x ↗ 2: 10.3x ← 3: 10.4x ↖ 4: 10.5x ↘ 5: 10.6x ↗ 6: 10.7x ← 7: 10.5x → 8: 10.6x → 9: 10.3x ↗ 10: 10.5x →		1: 10.2x ↖ 2: 10.8x ↗ 3: 10.6x ↘ 4: 10.5x → 5: 10.7x ↘ 6: 10.4x ↘ 7: 10.8x → 8: 10.6x → 9: 10.6x ↗ 10: 10.6x ↘	
		Series 104.8		Series 105.8	
		526.4		632.2	

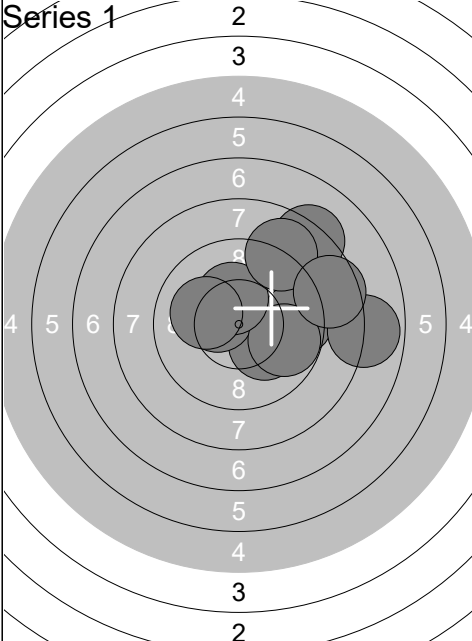
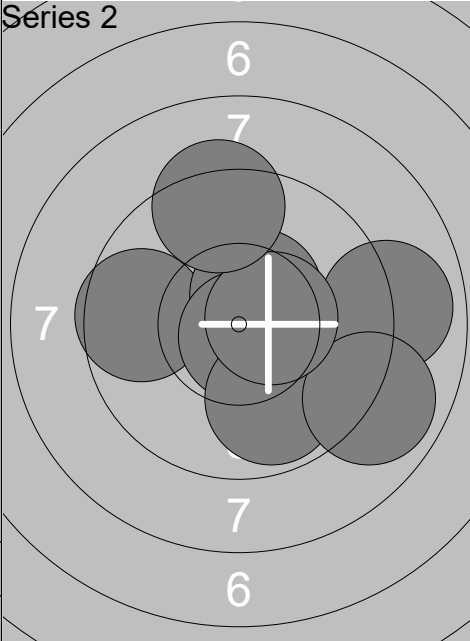
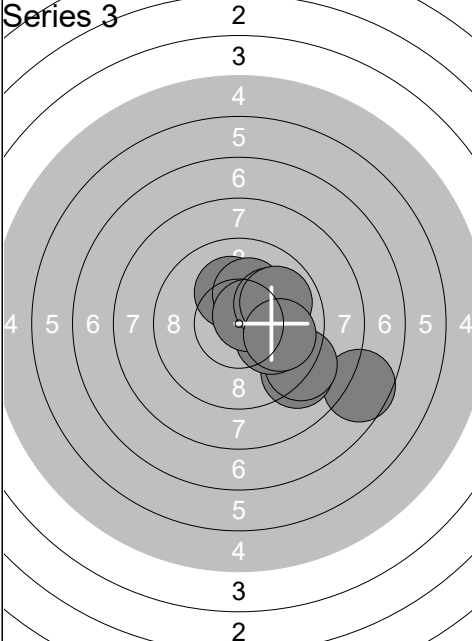
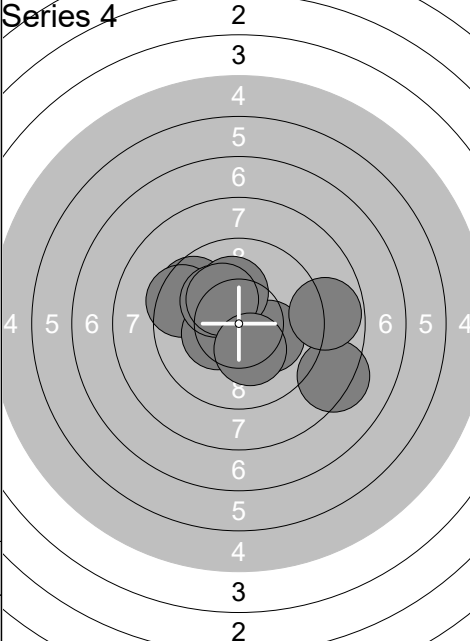
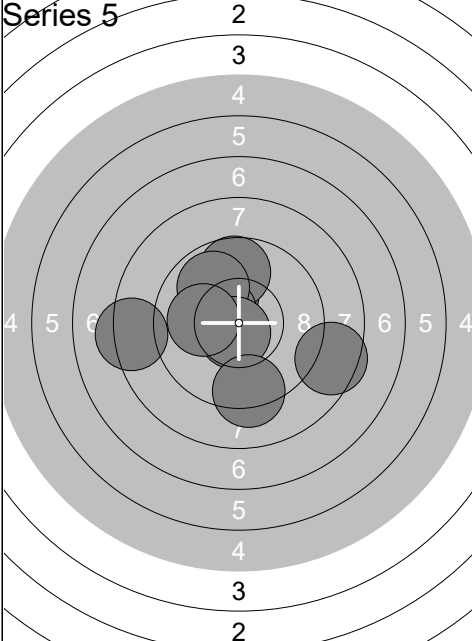
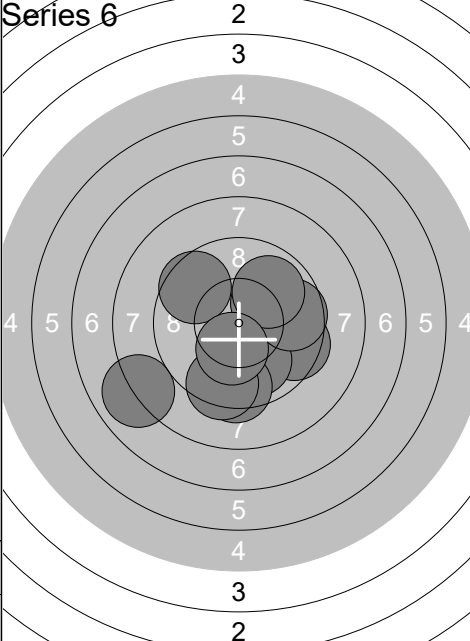
Relay	Lane	Ross Donaldson			
Qual Day 3		GBR		M	R
11.02.2026		Denmark Open Air 2026		Denmark Open Air 2026	
Series 1		1: 8.3 ↗		1: 9.6 ←	
		2: 9.5 →		2: 10.5x ↘	
		3: 10.1 ↘		3: 10.5x ↗	
		4: 10.4x ↙		4: 10.8x ↘	
		5: 9.8 →		5: 9.7 ↘	
		6: 7.9 →		6: 8.9 →	
		7: 10.3x ↗		7: 9.9 ↘	
		8: 8.9 ↗		8: 8.9 ↘	
		9: 8.6 →		9: 10.5x →	
		10: 10.1 ←		10: 9.3 ↗	
		Series 93.9		Series 98.6	
		93.9		192.5	
Series 3		1: 10.1 ↗		1: 8.3 ↘	
		2: 7.6 ↘		2: 9.6 ↗	
		3: 9.1 ↘		3: 9.4 ↙	
		4: 10.2x ↗		4: 10.4x ↙	
		5: 9.1 ↘		5: 10.1 ↘	
		6: 10.1 ↘		6: 10.1 ↗	
		7: 10.6x ↗		7: 10.2x ↗	
		8: 10.1 ↗		8: 10.2x ↗	
		9: 9.9 ↗		9: 8.8 →	
		10: 9.9 →		10: 10.3x ↘	
		Series 96.7		Series 97.4	
		289.2		386.6	
Series 5		1: 10.1 ↗		1: 9.5 ↗	
		2: 10.0 ↗		2: 9.5 →	
		3: 9.7 ↗		3: 10.1 ↗	
		4: 10.4x ↙		4: 10.0 ↘	
		5: 9.9 ↗		5: 9.7 →	
		6: 10.7x ↘		6: 9.4 ↘	
		7: 9.3 ↘		7: 9.9 ↗	
		8: 8.5 →		8: 9.4 ↘	
		9: 8.3 ←		9: 7.9 ↙	
		10: 10.1 ←		10: 10.3x ↘	
		Series 97.0		Series 95.7	
		483.6		579.3	

Relay	Lane	Emil Ala-Kulju		
1	13	SWE	M	R
Qual Day 3		Denmark Open Air 2026		Denmark Open Air 2026
11.02.2026				
Series 1 	1: 10.1 ←	Series 2 	1: 9.8 ←	
	2: 10.7x ↑		2: 9.4 ↑	
	3: 9.2 ↗		3: 10.9x ↗	
	4: 10.5x ↘		4: 10.4x →	
	5: 10.8x ←		5: 9.7 →	
	6: 9.1 ←		6: 10.5x ↑	
	7: 10.8x →		7: 9.8 ↘	
	8: 10.8x ↘		8: 10.7x ↘	
	9: 10.3x ↑		9: 10.0 ←	
	10: 10.0 →		10: 9.9 →	
	Series 102.3	Series 101.1		
	102.3	203.4		
Series 3 	1: 10.9x →	Series 4 	1: 9.3 ←	
	2: 9.6 →		2: 9.8 ←	
	3: 10.4x ↘		3: 9.9 ↗	
	4: 10.6x ↑		4: 9.6 →	
	5: 9.9 ↗		5: 9.3 ↑	
	6: 9.8 ↗		6: 10.6x ↘	
	7: 10.7x ↖		7: 9.2 →	
	8: 9.8 ←		8: 10.1 ↑	
	9: 9.1 ↓		9: 9.3 →	
	10: 10.5x ↘		10: 9.5 ↗	
	Series 101.3	Series 96.6		
	304.7	401.3		
Series 5 	1: 10.0 ←	Series 6 	1: 10.5x ↘	
	2: 9.6 ↗		2: 9.5 ↑	
	3: 9.6 ↑		3: 9.9 ←	
	4: 10.3x →		4: 10.5x ↘	
	5: 10.4x ↘		5: 9.9 ↗	
	6: 9.3 →		6: 9.0 →	
	7: 10.7x →		7: 10.4x ↑	
	8: 10.2x ↑		8: 10.2x ↗	
	9: 10.0 ↑		9: 10.5x ↘	
	10: 9.9 →		10: 9.8 ←	
	Series 100.0	Series 100.2		
	501.3	601.5		

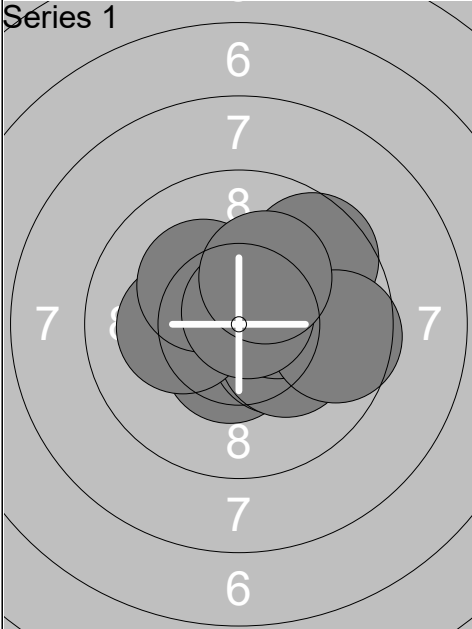
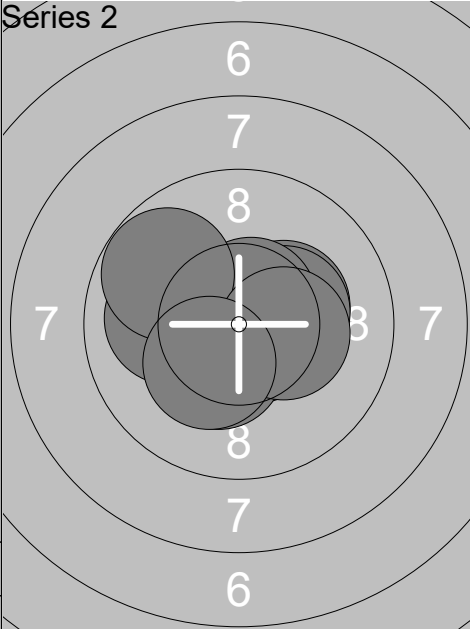
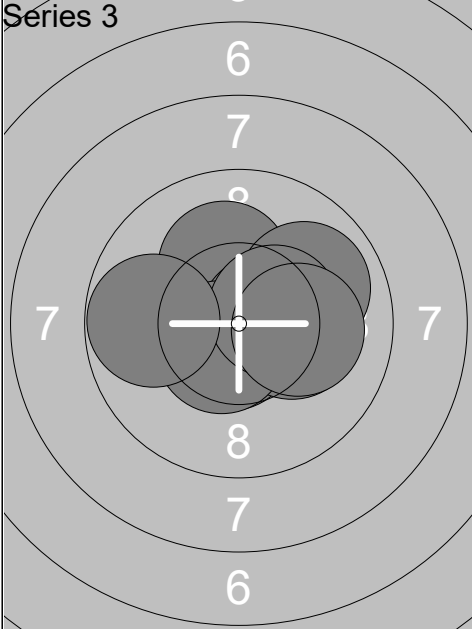
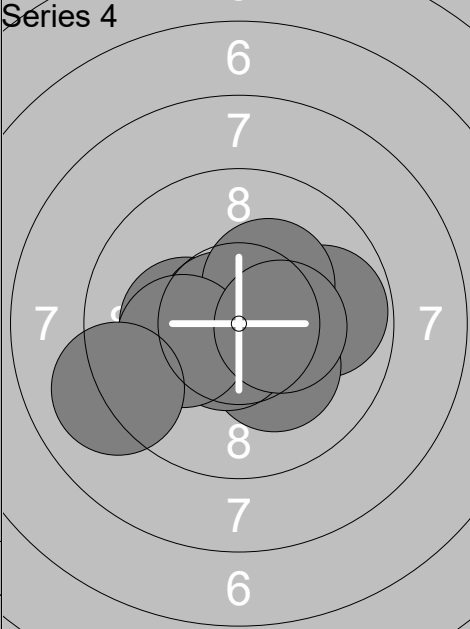
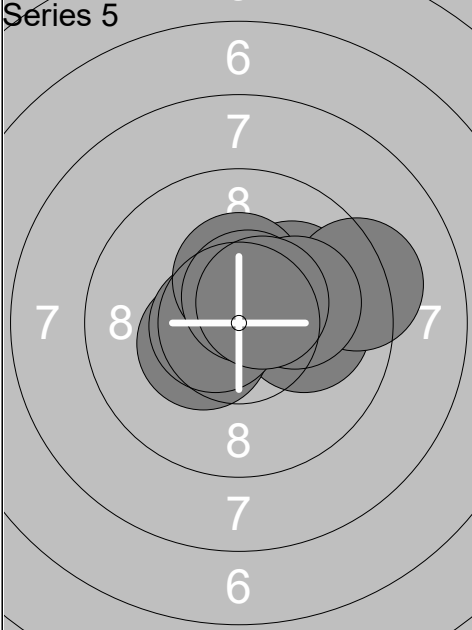
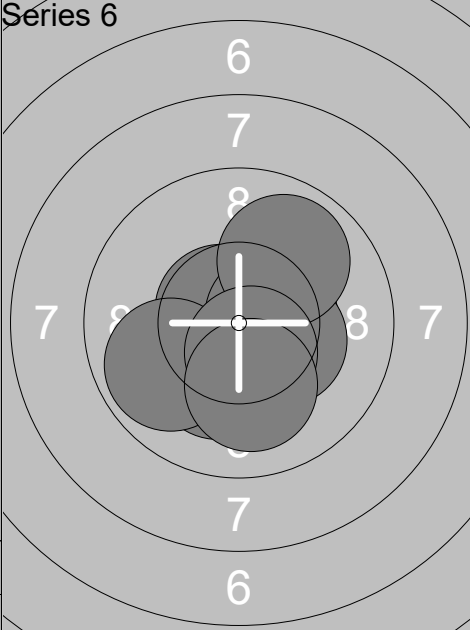
Relay	Lane	Jens Frimann		
1	14	DEN	M	R
Qual Day 3		Denmark Open Air 2026		Denmark Open Air 2026
11.02.2026		Denmark Open Air 2026		Denmark Open Air 2026
Series 1 	1: 10.5x ↓	Series 2 	1: 10.3x →	
	2: 10.4x ↘		2: 10.3x →	
	3: 10.2x ↘		3: 10.7x ↘	
	4: 10.2x ←		4: 10.4x ↓	
	5: 9.6 ↗		5: 10.0 ←	
	6: 10.4x →		6: 10.7x ←	
	7: 9.6 →		7: 10.6x ↗	
	8: 10.3x ↖		8: 9.8 ↖	
	9: 10.8x ↗		9: 10.3x →	
	10: 10.2x ↗		10: 10.3x ↓	
	Series 102.2		Series 103.4	
	102.2		205.6	
Series 3 	1: 10.7x ↓	Series 4 	1: 10.2x ←	
	2: 10.9x ↓		2: 10.6x ↗	
	3: 10.2x ↑		3: 9.8 →	
	4: 10.6x →		4: 10.8x ↖	
	5: 9.9 ↗		5: 10.2x ↘	
	6: 10.2x →		6: 10.6x ↓	
	7: 10.6x ↓		7: 10.3x ↗	
	8: 10.4x →		8: 10.2x ←	
	9: 9.8 ←		9: 10.4x →	
	10: 10.2x →		10: 9.1 ↖	
	Series 103.5		Series 102.2	
	309.1		411.3	
Series 5 	1: 10.1 ↗	Series 6 	1: 10.2x ↓	
	2: 10.5x ↗		2: 10.8x ↗	
	3: 10.1 →		3: 10.6x ↓	
	4: 10.4x ↖		4: 10.6x ↖	
	5: 10.6x ←		5: 9.9 ↖	
	6: 10.3x ↑		6: 10.5x →	
	7: 9.3 →		7: 10.4x →	
	8: 10.6x ↑		8: 9.9 ↗	
	9: 10.2x →		9: 10.5x ↓	
	10: 10.5x ↗		10: 10.1 ↓	
	Series 102.6		Series 103.5	
	513.9		617.4	

Relay	Lane	Keven Clausen		
1	15	DEN	M	R
Qual Day 3		Denmark Open Air 2026		Denmark Open Air 2026
11.02.2026		Denmark Open Air 2026		Denmark Open Air 2026
Series 1 	1: 10.3x ↓	Series 2 	1: 10.3x ↓	
	2: 10.6x ↓		2: 9.5 ←	
	3: 10.8x →		3: 9.8 ↑	
	4: 10.4x ←		4: 10.5x ↗	
	5: 9.5 ←		5: 9.3 ↑	
	6: 10.1 →		6: 9.8 ↑	
	7: 10.4x →		7: 10.3x →	
	8: 10.3x ↓		8: 10.7x ←	
	9: 9.5 ↓		9: 9.6 ↓	
	10: 10.8x ←		10: 10.0 ↓	
	Series 102.7	Series 99.8		
	102.7		202.5	
Series 3 	1: 8.4 ←	Series 4 	1: 9.9 ↖	
	2: 9.7 ↓		2: 9.6 ↓	
	3: 9.9 ↑		3: 9.5 ↗	
	4: 10.2x ←		4: 10.3x ↓	
	5: 10.2x ↓		5: 9.6 ↓	
	6: 9.2 ↗		6: 8.7 ←	
	7: 9.7 →		7: 9.1 ←	
	8: 10.0 ←		8: 9.6 ↓	
	9: 9.4 ↓		9: 9.6 ↓	
	10: 10.3x ↓		10: 10.5x ↓	
	Series 97.0	Series 96.4		
	299.5		395.9	
Series 5 	1: 10.1 ↗	Series 6 	1: 10.7x ↑	
	2: 10.2x ↓		2: 9.8 ↓	
	3: 10.2x ↓		3: 10.4x ↗	
	4: 9.9 ↑		4: 9.5 →	
	5: 10.4x →		5: 9.7 ↑	
	6: 10.6x ←		6: 10.6x ←	
	7: 10.7x ↓		7: 10.6x ↖	
	8: 9.4 →		8: 10.1 ←	
	9: 9.8 ←		9: 9.3 ↓	
	10: 8.7 →		10: 9.4 ←	
	Series 100.0	Series 100.1		
	495.9		596.0	

Relay	Lane	Roni Airo		
1	16	FIN	M	R
Qual Day 3		Denmark Open Air 2026		Denmark Open Air 2026
11.02.2026		Denmark Open Air 2026		Denmark Open Air 2026
Series 1 	1: 10.1 ↑	Series 2 	1: 10.7x ↗	
	2: 9.3 ←		2: 9.7 ↓	
	3: 9.4 ↑		3: 10.6x ↙	
	4: 10.4x →		4: 10.2x ⇒	
	5: 10.5x ↖		5: 10.8x ↙	
	6: 10.0 ↗		6: 10.8x ↓	
	7: 9.9 ←		7: 9.9 →	
	8: 10.1 ↓		8: 9.8 ↓	
	9: 10.5x ↓		9: 10.5x ↓	
	10: 9.8 ⇒		10: 10.5x ↖	
	Series 100.0		Series 103.5	
	100.0		203.5	
Series 3 	1: 10.4x →	Series 4 	1: 10.7x ↖	
	2: 10.6x ↓		2: 10.5x ↑	
	3: 10.5x ↗		3: 10.3x ↖	
	4: 10.7x ↑		4: 10.1 ↑	
	5: 10.7x ↑		5: 10.5x ↖	
	6: 10.4x ↑		6: 10.4x ↙	
	7: 10.8x ↗		7: 10.3x ↗	
	8: 10.2x ↖		8: 10.2x ↗	
	9: 10.5x ↖		9: 10.5x →	
	10: 10.2x ↖		10: 9.4 ↖	
	Series 105.0		Series 102.9	
	308.5		411.4	
Series 5 	1: 10.7x ↖	Series 6 	1: 10.1 ↗	
	2: 9.9 ↑		2: 10.5x ⇒	
	3: 10.4x ↑		3: 10.2x ↖	
	4: 10.8x ↗		4: 10.4x ↓	
	5: 10.0 ←		5: 10.1 ↙	
	6: 10.1 ↗		6: 9.6 ↖	
	7: 10.3x ↖		7: 10.0 ↗	
	8: 10.0 ↖		8: 10.4x →	
	9: 9.9 ↑		9: 10.7x ↑	
	10: 10.6x ↖		10: 10.6x ↑	
	Series 102.7		Series 102.6	
	514.1		616.7	

Relay	Lane	Björn Friman			
1	17	FIN		M	R
Qual Day 3		Denmark Open Air 2026		Denmark Open Air 2026	
11.02.2026		Denmark Open Air 2026		Denmark Open Air 2026	
Series 1 	1: 10.6x ↗	Series 2 	1: 10.7x ↘		
	2: 10.2x ←		2: 10.2x ↓		
	3: 10.7x ↘		3: 10.5x ←		
	4: 10.0 ↘		4: 10.6x ↘		
	5: 10.6x ↗		5: 10.6x ↘		
	6: 9.9 ←		6: 10.1 ↖		
	7: 10.0 ←		7: 10.0 ↓		
	8: 9.9 ←		8: 10.6x ↘		
	9: 10.2x ↘		9: 10.1 ↗		
	10: 8.9 ↘		10: 10.1 ↗		
	Series 101.0		Series 103.5		
	101.0		204.5		
Series 3 	1: 8.8 →	Series 4 	1: 10.3x →		
	2: 9.9 ↘		2: 9.6 ↗		
	3: 10.1 ↘		3: 10.0 →		
	4: 10.0 ←		4: 10.4x ←		
	5: 10.6x →		5: 10.4x ↖		
	6: 10.4x ↖		6: 9.8 ↘		
	7: 9.8 ↘		7: 10.3x ↘		
	8: 10.2x ↓		8: 10.2x ↗		
	9: 10.2x →		9: 10.2x ↗		
	10: 9.5 →		10: 9.9 ↗		
	Series 99.5		Series 101.1		
	304.0		405.1		
Series 5 	1: 10.1 ↗	Series 6 	1: 10.1 ←		
	2: 9.6 ↘		2: 10.4x ↗		
	3: 10.2x ←		3: 10.6x →		
	4: 10.5x ←		4: 10.3x →		
	5: 10.4x ↘		5: 9.9 ←		
	6: 10.3x ↗		6: 10.0 ↖		
	7: 10.1 →		7: 10.3x ↓		
	8: 10.3x ↘		8: 10.9x ↓		
	9: 10.4x →		9: 9.9 ←		
	10: 10.3x ←		10: 10.0 →		
	Series 102.2		Series 102.4		
	507.3		609.7		

Relay	Lane	Jan Winther		
1	19	DEN	M	R
Qual Day 3		Denmark Open Air 2026		Denmark Open Air 2026
11.02.2026				
Series 1 	1: 10.4x ↖	Series 2 	1: 10.1 ↓	
	2: 9.7 ↗		2: 10.6x ↙	
	3: 10.5x ↖		3: 10.7x →	
	4: 10.3x ↗		4: 10.8x ↖	
	5: 10.1 ↓		5: 10.5x ↗	
	6: 10.5x ↗		6: 10.9x ↖	
	7: 10.8x →		7: 10.8x →	
	8: 10.1 ↗		8: 10.5x ←	
	9: 9.6 ↑		9: 10.4x ↘	
	10: 10.8x ↘		10: 10.9x →	
	Series 102.8		Series 106.2	
	102.8		209.0	
Series 3 	1: 10.1 ↗	Series 4 	1: 10.7x ↑	
	2: 9.7 ↗		2: 10.1 ↖	
	3: 10.6x ←		3: 10.6x ↓	
	4: 10.6x ←		4: 10.6x ↓	
	5: 10.5x ↗		5: 10.0 ↑	
	6: 10.6x ↘		6: 10.4x ←	
	7: 10.6x ↓		7: 10.4x ↗	
	8: 10.4x ↗		8: 10.8x →	
	9: 10.2x ↗		9: 10.1 ←	
	10: 10.7x ↑		10: 10.2x ↘	
	Series 104.0		Series 103.9	
	313.0		416.9	
Series 5 	1: 10.1 ↓	Series 6 	1: 10.1 ←	
	2: 10.7x ↗		2: 10.7x ↘	
	3: 10.5x ↗		3: 10.4x →	
	4: 10.4x ←		4: 10.4x ↙	
	5: 10.8x ↓		5: 10.5x ↑	
	6: 10.7x ↓		6: 10.6x ↗	
	7: 10.2x ↓		7: 10.5x ←	
	8: 10.6x ↑		8: 10.5x ←	
	9: 10.7x ↙		9: 10.5x ↖	
	10: 10.7x →		10: 9.9 ↑	
	Series 105.4		Series 104.1	
	522.3		626.4	

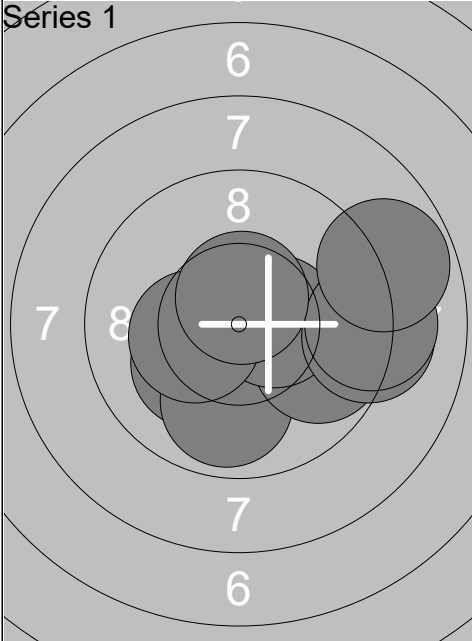
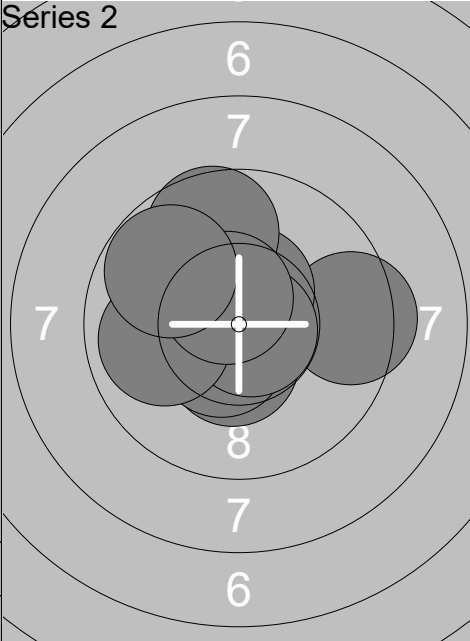
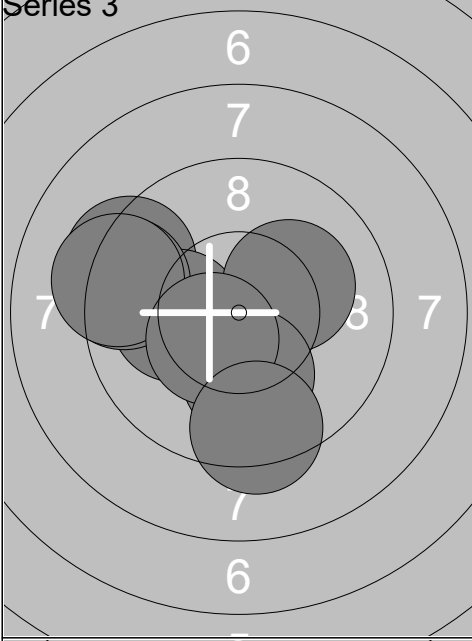
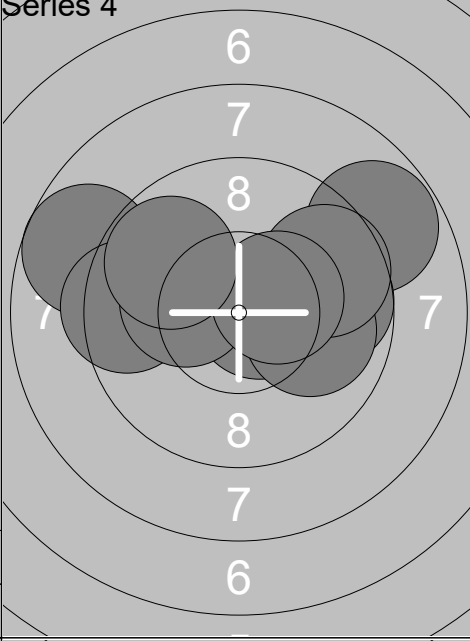
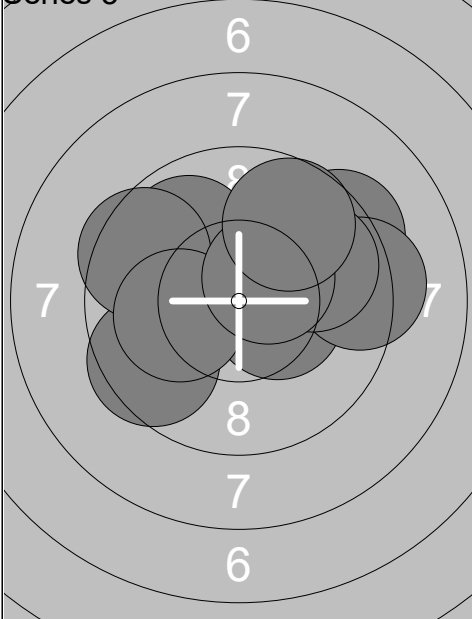
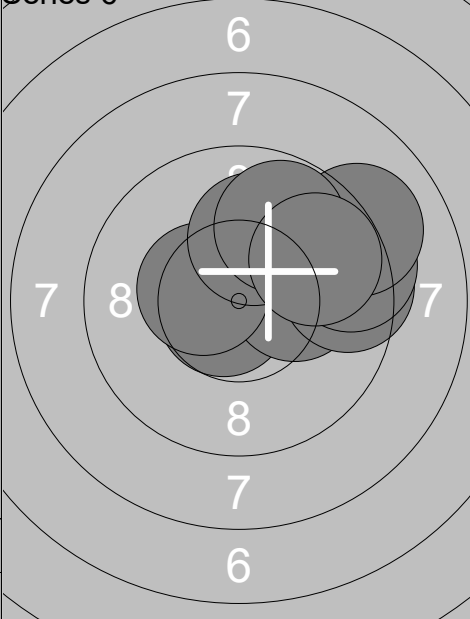
Relay	Lane	Kasper Lousdal		
1	20	DEN	M	R
Qual Day 3		Denmark Open Air 2026		Denmark Open Air 2026
11.02.2026		Denmark Open Air 2026		Denmark Open Air 2026
Series 1 	1: 10.3x ↓	Series 2 	1: 9.4 →	
	2: 10.2x ↙		2: 10.5x ↑	
	3: 9.9 ↓		3: 10.5x ↓	
	4: 9.8 →		4: 10.5x ↙	
	5: 10.5x →		5: 10.8x →	
	6: 10.3x ↙		6: 10.0 ↖	
	7: 9.2 →		7: 9.9 ←	
	8: 9.2 →		8: 9.7 ↑	
	9: 10.6x ↑		9: 10.5x ↗	
	10: 8.9 →		10: 9.8 ↖	
	Series 98.9		Series 101.6	
	98.9		200.5	
Series 3 	1: 10.6x ↓	Series 4 	1: 10.7x →	
	2: 9.3 ↖		2: 8.8 ↗	
	3: 10.6x ↙		3: 9.8 →	
	4: 10.1 ←		4: 10.0 →	
	5: 9.3 ↖		5: 9.6 ↗	
	6: 9.3 ↖		6: 8.8 ↖	
	7: 10.2x ↗		7: 9.4 ←	
	8: 10.1 ↓		8: 10.2x ↙	
	9: 10.4x ↙		9: 10.4x →	
	10: 9.4 ↓		10: 9.8 ↖	
	Series 99.3		Series 97.5	
	299.8		397.3	
Series 5 	1: 10.4x →	Series 6 	1: 10.7x ↙	
	2: 9.5 ↖		2: 10.2x →	
	3: 9.3 ↗		3: 9.5 →	
	4: 9.3 →		4: 10.4x ↙	
	5: 9.9 ↖		5: 9.3 →	
	6: 9.9 →		6: 9.8 ↗	
	7: 9.5 ↖		7: 10.1 ↑	
	8: 10.1 ←		8: 9.1 ↗	
	9: 10.5x ↗		9: 9.8 ↑	
	10: 9.7 ↗		10: 9.8 ↗	
	Series 98.1		Series 98.7	
	495.4		594.1	

Relay	Lane	Paul Kronemann		
1	21	GER	M	R
Qual Day 3		Denmark Open Air 2026		Denmark Open Air 2026
11.02.2026				
Series 1 	1: 10.3x ↑	Series 2 	1: 10.3x ↖	
	2: 10.5x ↙		2: 10.2x ↖	
	3: 8.9 ↖		3: 10.8x ↘	
	4: 9.3 →		4: 10.6x →	
	5: 10.0 →		5: 10.0 ↓	
	6: 10.9x →		6: 9.9 ↗	
	7: 10.0 ↑		7: 10.5x →	
	8: 9.8 ↘		8: 9.9 →	
	9: 9.7 ↘		9: 10.5x ↙	
	10: 10.2x ↗		10: 10.1 ↖	
	Series 99.6	Series 102.8		
	99.6	202.4		
Series 3 	1: 10.8x ←	Series 4 	1: 9.9 ↓	
	2: 10.7x ↙		2: 10.2x ↓	
	3: 10.1 ←		3: 9.7 ↓	
	4: 10.2x ↗		4: 10.2x →	
	5: 10.3x ←		5: 9.8 ←	
	6: 9.6 ↑		6: 8.6 ↙	
	7: 10.1 ←		7: 10.4x ↑	
	8: 10.2x ↗		8: 10.3x ↗	
	9: 10.5x ↗		9: 10.3x ↑	
	10: 10.3x ←		10: 10.6x ↓	
	Series 102.8	Series 100.0		
	305.2	405.2		
Series 5 	1: 10.4x ↘	Series 6 	1: 9.6 ↖	
	2: 9.8 ↖		2: 10.0 ↖	
	3: 10.2x ↓		3: 9.8 ↖	
	4: 10.7x ↗		4: 10.8x ↑	
	5: 10.5x ↖		5: 9.5 ↓	
	6: 10.6x ↗		6: 10.4x ↑	
	7: 10.8x ↓		7: 9.9 ↑	
	8: 10.4x ↗		8: 9.9 ←	
	9: 10.6x ↙		9: 9.8 ←	
	10: 10.2x ↖		10: 10.7x ←	
	Series 104.2	Series 100.4		
	509.4	609.8		

Relay	Lane	Victor Lindgren		
1	22	SWE	M	R
Qual Day 3		Denmark Open Air 2026		Denmark Open Air 2026
11.02.2026		Denmark Open Air 2026		Denmark Open Air 2026
Series 1 	1: 10.7x ←	Series 2 	1: 10.5x ↗	
	2: 10.1 ←		2: 10.4x ↓	
	3: 10.6x ↘		3: 10.8x ↓	
	4: 10.7x ↓		4: 10.5x ↓	
	5: 10.8x ←		5: 10.8x ↗	
	6: 10.3x ↓		6: 10.6x ↘	
	7: 10.9x ←		7: 10.8x ↓	
	8: 10.2x ↓		8: 10.3x ↗	
	9: 10.5x →		9: 10.6x ↑	
	10: 10.3x ↗		10: 10.8x ↓	
	Series 105.1		Series 106.1	
	105.1		211.2	
Series 3 	1: 10.8x ↑	Series 4 	1: 10.5x ↗	
	2: 10.5x ↓		2: 10.8x ↑	
	3: 10.2x →		3: 10.5x ←	
	4: 10.7x ↑		4: 10.8x ↘	
	5: 10.9x ↗		5: 10.7x ←	
	6: 10.7x ↑		6: 10.2x ↓	
	7: 10.7x →		7: 10.7x ←	
	8: 10.7x ↖		8: 10.5x ↖	
	9: 10.4x ↗		9: 10.8x →	
	10: 10.6x →		10: 10.3x ↓	
	Series 106.2		Series 105.8	
	317.4		423.2	
Series 5 	1: 10.6x ↘	Series 6 	1: 10.7x →	
	2: 10.4x ↖		2: 10.4x →	
	3: 10.4x ↘		3: 10.5x ↓	
	4: 10.7x ↓		4: 10.7x →	
	5: 10.4x ↗		5: 10.5x ↗	
	6: 10.5x ←		6: 10.6x ↖	
	7: 10.6x ↑		7: 10.7x ↑	
	8: 10.4x ↖		8: 10.6x ↗	
	9: 10.3x ↗		9: 10.4x ↓	
	10: 10.6x →		10: 10.4x →	
	Series 104.9		Series 105.5	
	528.1		633.6	