

Relay 2	Lane 4	Ann Helen Aune
-------------------	------------------	-----------------------

Mix Team Pistol Qual	NOR 1	Wp	P
----------------------	-------	----	---

11.02.2026	Denmark Open Air 2026	Denmark Open Air 2026
------------	-----------------------	-----------------------

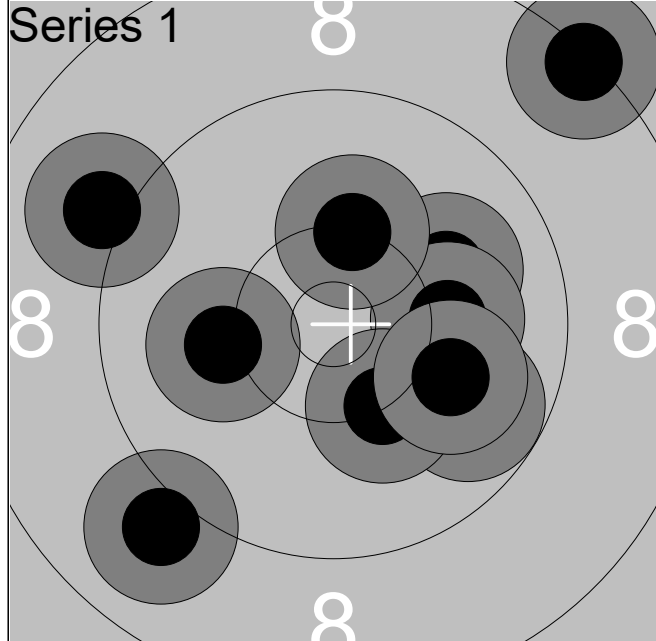

1:	10.0	➔
2:	10.1	➔
3:	9.8	➘
4:	8.3	↗
5:	9.1	↖
6:	10.3	↑
7:	10.3	↓
8:	10.1	←
9:	9.0	↙
10:	10.0	➔

Series	95 (0x)
	95 (0x)

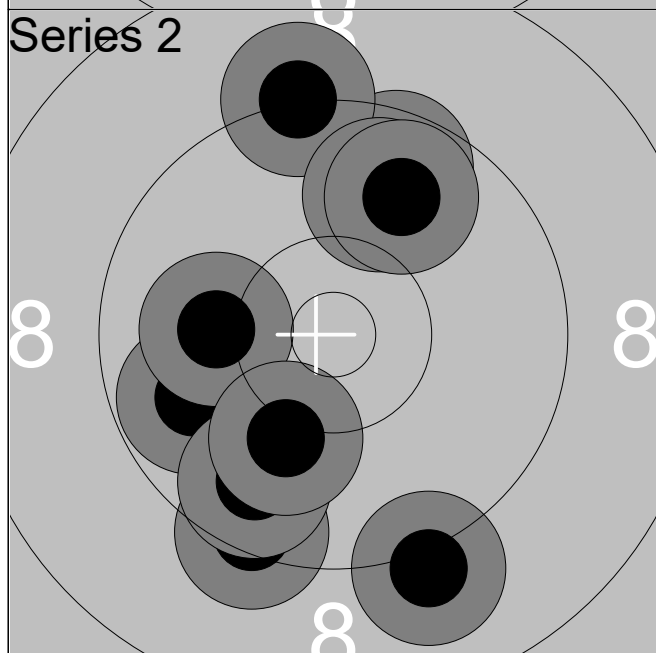

1:	9.6	↑
2:	9.2	↑
3:	9.9	↑
4:	9.1	↓
5:	9.8	↖
6:	9.4	↓
7:	10.1	←
8:	9.8	↑
9:	9.7	↓
10:	10.1	↓

Series	92 (0x)
	187 (0x)

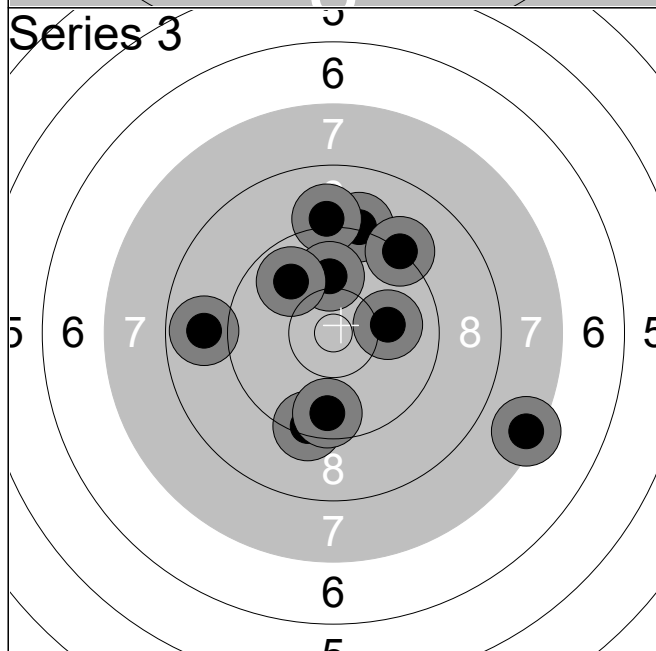

1:	9.2	↑
2:	9.2	↗
3:	9.4	↓
4:	8.9	←
5:	9.1	↑
6:	10.0	↑
7:	10.1	➔
8:	9.6	↓
9:	9.9	↗
10:	7.4	➔

Series	89 (0x)
	276 (0x)

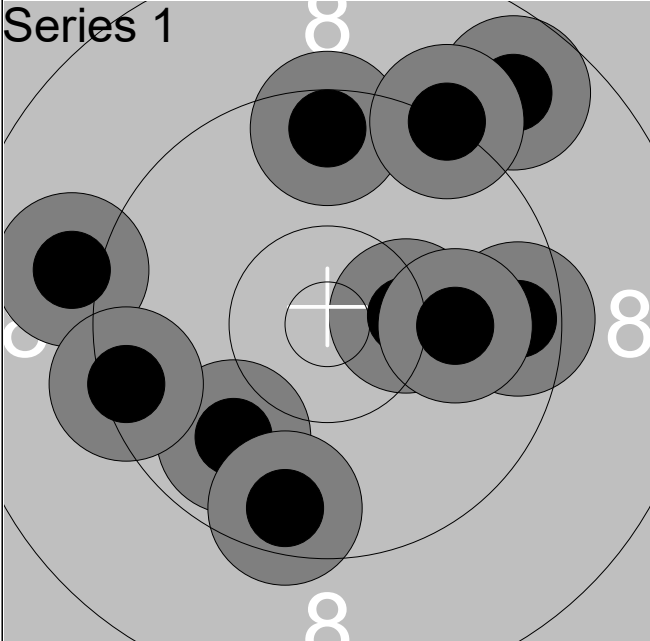
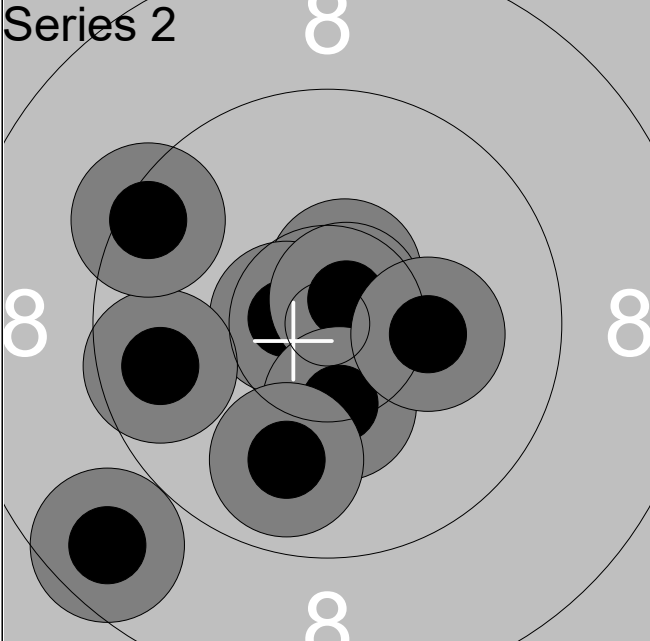
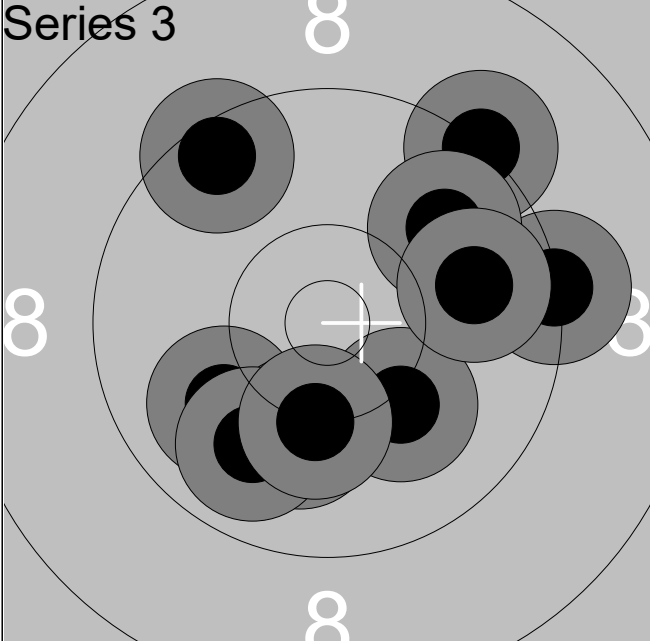
Relay 2	Lane 5	Ingar Woll		
Mix Team Pistol Qual	NOR 1	Vp	P	
11.02.2026	Denmark Open Air 2026	Denmark Open Air 2026		
Series 1 	1:	9.0	←	
	2:	9.6	→	
	3:	10.4x	→	
	4:	8.8	↗	
	5:	9.5	↑	
	6:	9.9	↙	
	7:	9.4	←	
	8:	9.6	↓	
	9:	10.0	→	
	10:	9.2	↗	
	Series			91 (1x)
			91 (1x)	
Series 2 	1:	10.7x	↗	
	2:	8.7	↙	
	3:	10.6x	↑	
	4:	10.6x	←	
	5:	9.7	←	
	6:	10.7x	↗	
	7:	9.4	↖	
	8:	10.4x	↓	
	9:	9.9	↓	
	10:	10.2	→	
	Series			95 (5x)
			186 (6x)	
Series 3 	1:	9.3	→	
	2:	10.1	↘	
	3:	10.0	↙	
	4:	10.1	↓	
	5:	9.9	↙	
	6:	9.5	↗	
	7:	9.2	↗	
	8:	10.2	↓	
	9:	9.8	↗	
	10:	9.8	→	
	Series			94 (0x)
			280 (6x)	

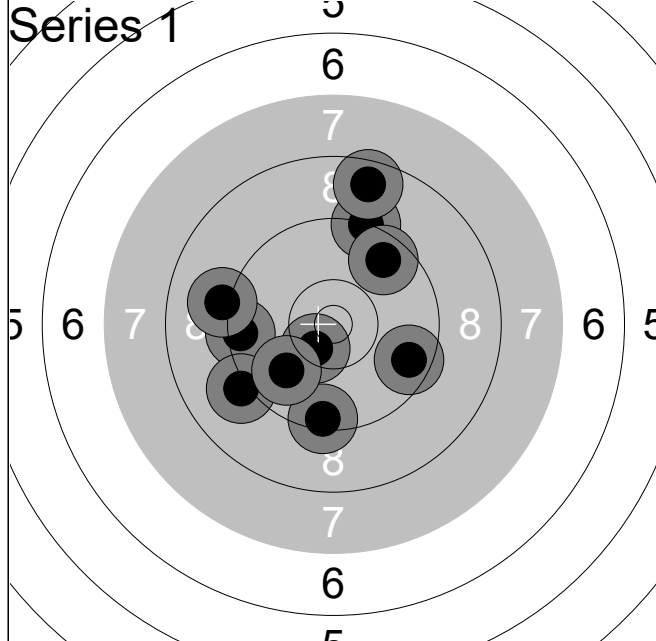

1:	9.4	↓
2:	9.6	→
3:	9.4	←
4:	9.1	↙
5:	9.2	↑
6:	9.1	←
7:	9.6	↗
8:	10.5x	↘
9:	9.9	↘
10:	8.6	↑
Series		90 (1x)
		90 (1x)

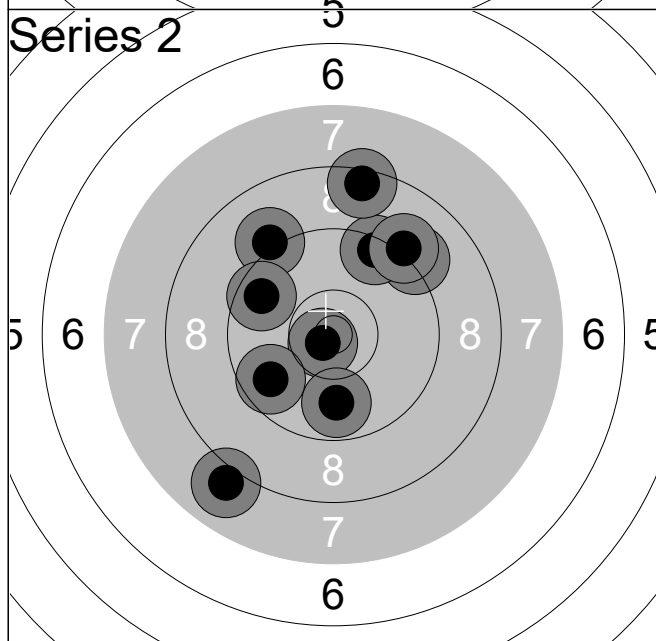

1:	10.7x	↙
2:	9.2	↗
3:	9.1	↖
4:	9.4	↑
5:	9.8	↓
6:	9.7	↙
7:	8.5	↑
8:	8.0	↘
9:	9.1	↗
10:	9.6	↖
Series		89 (1x)
		179 (2x)

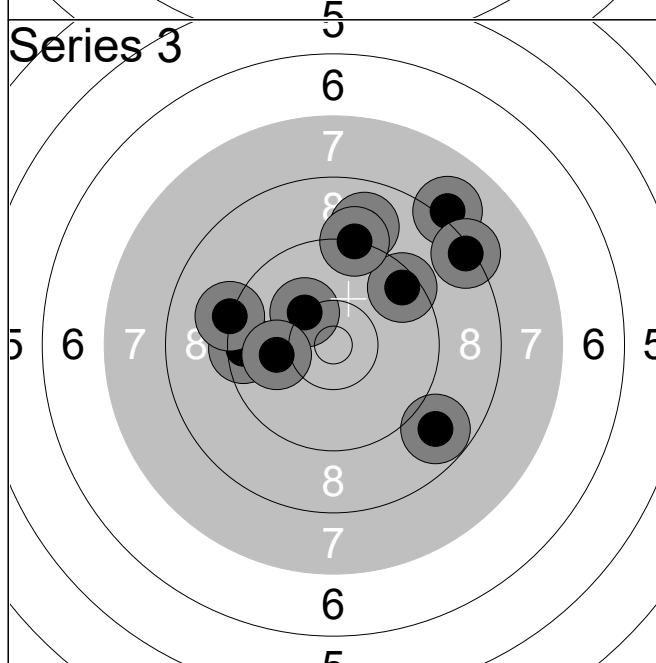

1:	9.5	←
2:	10.3	↖
3:	8.1	↗
4:	8.8	↘
5:	9.0	↑
6:	9.2	←
7:	10.0	←
8:	9.5	↗
9:	9.2	↑
10:	8.3	↗
Series		89 (0x)
		268 (2x)

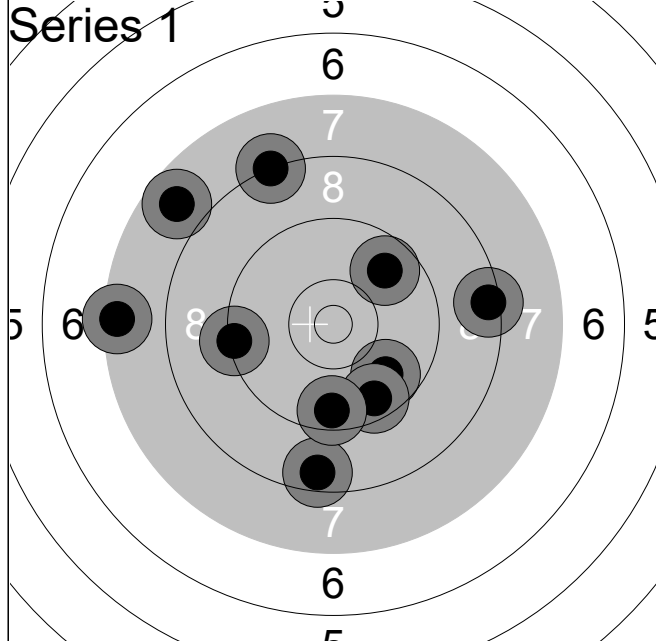

1:	9.8	↘
2:	8.2	↗
3:	9.6	↘
4:	7.4	←
5:	8.5	↓
6:	9.6	↓
7:	8.4	→
8:	9.7	↗
9:	7.8	↖
10:	9.3	←
Series		83 (0x)
		83 (0x)

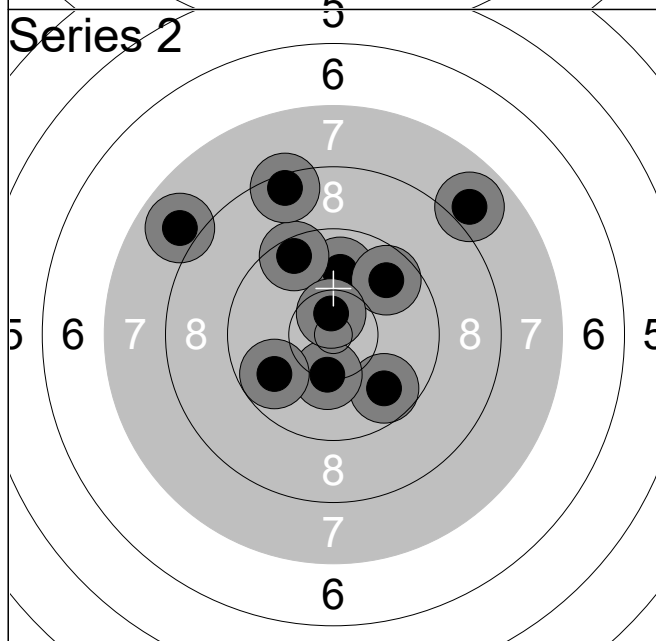

1:	9.7	↘
2:	10.3	↓
3:	9.9	↑
4:	7.9	↗
5:	7.9	↖
6:	9.8	←
7:	9.5	↗
8:	9.7	↗
9:	8.4	↑
10:	10.6x	↑
Series		87 (1x)
		170 (1x)

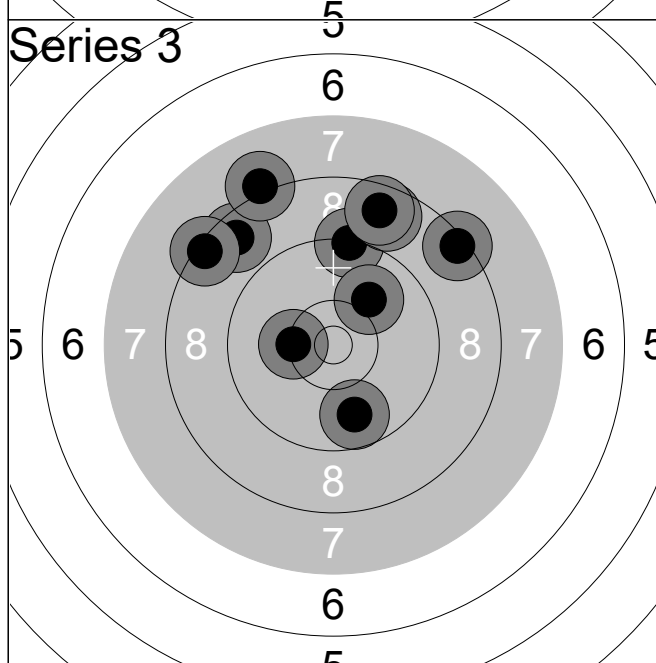

1:	8.6	↖
2:	9.3	↑
3:	8.1	↗
4:	9.8	↓
5:	10.3	←
6:	10.0	↗
7:	8.4	↗
8:	8.4	↖
9:	8.7	↑
10:	8.6	↑
Series		86 (0x)
		256 (1x)

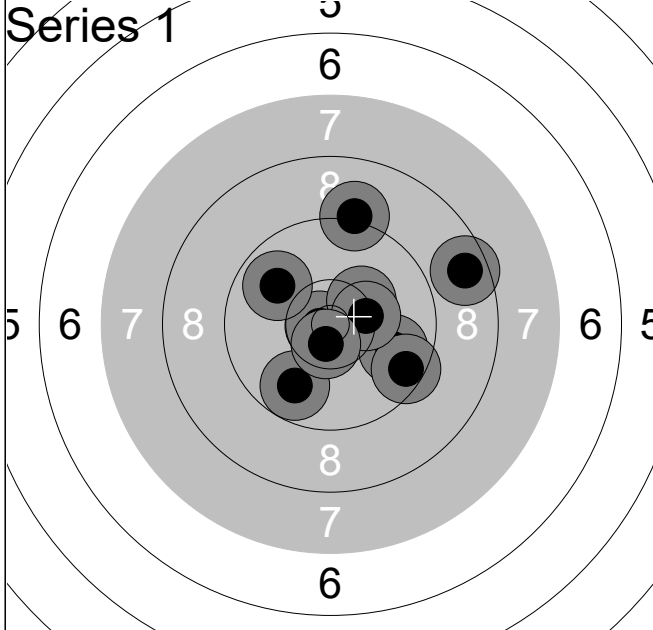
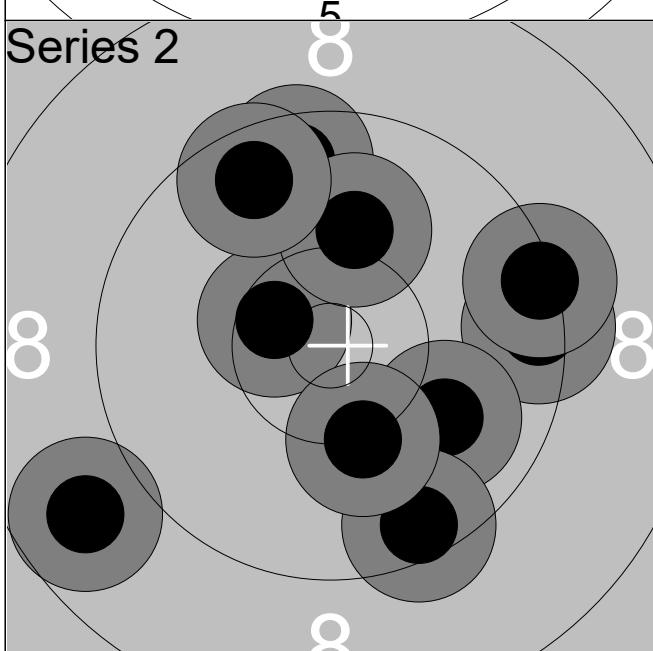
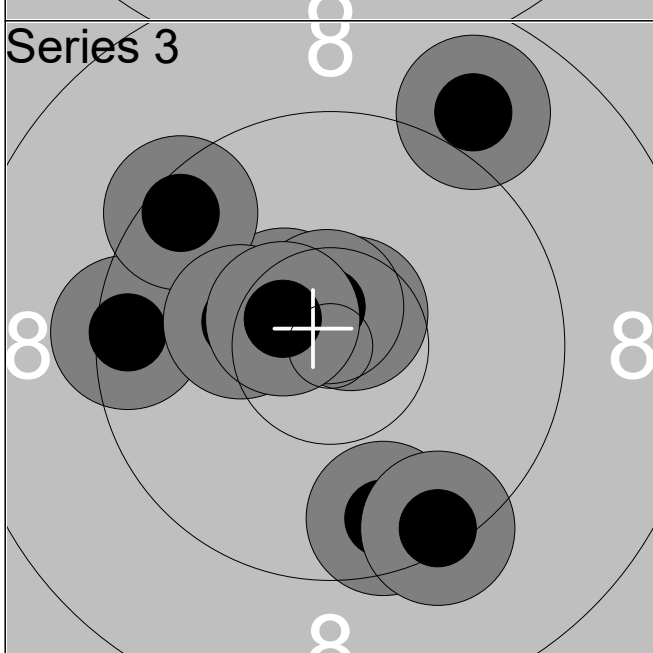
11.02.2026	Denmark Open Air 2026	Denmark Open Air 2026																																		
Series 1 	<table style="width:100%; border-collapse: collapse;"> <tr><td style="width:5%;">1:</td><td style="width:85%;">10.8x</td><td style="width:10%; text-align: right;">←</td></tr> <tr><td>2:</td><td>9.2</td><td style="text-align: right;">↑</td></tr> <tr><td>3:</td><td>9.9</td><td style="text-align: right;">→</td></tr> <tr><td>4:</td><td>8.6</td><td style="text-align: right;">↗</td></tr> <tr><td>5:</td><td>9.5</td><td style="text-align: right;">↘</td></tr> <tr><td>6:</td><td>10.3</td><td style="text-align: right;">↗</td></tr> <tr><td>7:</td><td>9.8</td><td style="text-align: right;">↓</td></tr> <tr><td>8:</td><td>10.4x</td><td style="text-align: right;">→</td></tr> <tr><td>9:</td><td>10.6x</td><td style="text-align: right;">↓</td></tr> <tr><td>10:</td><td>9.9</td><td style="text-align: right;">↖</td></tr> </table>	1:	10.8x	←	2:	9.2	↑	3:	9.9	→	4:	8.6	↗	5:	9.5	↘	6:	10.3	↗	7:	9.8	↓	8:	10.4x	→	9:	10.6x	↓	10:	9.9	↖	<table style="width:100%; border-collapse: collapse;"> <tr> <td style="width:80%;">Series</td> <td style="text-align: right;">93 (3x)</td> </tr> <tr> <td></td> <td style="text-align: right;">93 (3x)</td> </tr> </table>	Series	93 (3x)		93 (3x)
1:	10.8x	←																																		
2:	9.2	↑																																		
3:	9.9	→																																		
4:	8.6	↗																																		
5:	9.5	↘																																		
6:	10.3	↗																																		
7:	9.8	↓																																		
8:	10.4x	→																																		
9:	10.6x	↓																																		
10:	9.9	↖																																		
Series	93 (3x)																																			
	93 (3x)																																			
Series 2 	<table style="width:100%; border-collapse: collapse;"> <tr><td style="width:5%;">1:</td><td style="width:85%;">9.4</td><td style="width:10%; text-align: right;">→</td></tr> <tr><td>2:</td><td>10.0</td><td style="text-align: right;">↘</td></tr> <tr><td>3:</td><td>10.5x</td><td style="text-align: right;">↖</td></tr> <tr><td>4:</td><td>9.6</td><td style="text-align: right;">↑</td></tr> <tr><td>5:</td><td>9.5</td><td style="text-align: right;">↓</td></tr> <tr><td>6:</td><td>10.2</td><td style="text-align: right;">↓</td></tr> <tr><td>7:</td><td>10.1</td><td style="text-align: right;">↑</td></tr> <tr><td>8:</td><td>9.6</td><td style="text-align: right;">↑</td></tr> <tr><td>9:</td><td>9.3</td><td style="text-align: right;">→</td></tr> <tr><td>10:</td><td>8.8</td><td style="text-align: right;">↖</td></tr> </table>	1:	9.4	→	2:	10.0	↘	3:	10.5x	↖	4:	9.6	↑	5:	9.5	↓	6:	10.2	↓	7:	10.1	↑	8:	9.6	↑	9:	9.3	→	10:	8.8	↖	<table style="width:100%; border-collapse: collapse;"> <tr> <td style="width:80%;">Series</td> <td style="text-align: right;">93 (1x)</td> </tr> <tr> <td></td> <td style="text-align: right;">186 (4x)</td> </tr> </table>	Series	93 (1x)		186 (4x)
1:	9.4	→																																		
2:	10.0	↘																																		
3:	10.5x	↖																																		
4:	9.6	↑																																		
5:	9.5	↓																																		
6:	10.2	↓																																		
7:	10.1	↑																																		
8:	9.6	↑																																		
9:	9.3	→																																		
10:	8.8	↖																																		
Series	93 (1x)																																			
	186 (4x)																																			
Series 3 	<table style="width:100%; border-collapse: collapse;"> <tr><td style="width:5%;">1:</td><td style="width:85%;">8.9</td><td style="width:10%; text-align: right;">↗</td></tr> <tr><td>2:</td><td>9.5</td><td style="text-align: right;">←</td></tr> <tr><td>3:</td><td>9.6</td><td style="text-align: right;">↓</td></tr> <tr><td>4:</td><td>10.5x</td><td style="text-align: right;">↗</td></tr> <tr><td>5:</td><td>9.5</td><td style="text-align: right;">↗</td></tr> <tr><td>6:</td><td>9.4</td><td style="text-align: right;">↓</td></tr> <tr><td>7:</td><td>10.3</td><td style="text-align: right;">←</td></tr> <tr><td>8:</td><td>10.7x</td><td style="text-align: right;">↗</td></tr> <tr><td>9:</td><td>10.7x</td><td style="text-align: right;">↑</td></tr> <tr><td>10:</td><td>10.5x</td><td style="text-align: right;">↖</td></tr> </table>	1:	8.9	↗	2:	9.5	←	3:	9.6	↓	4:	10.5x	↗	5:	9.5	↗	6:	9.4	↓	7:	10.3	←	8:	10.7x	↗	9:	10.7x	↑	10:	10.5x	↖	<table style="width:100%; border-collapse: collapse;"> <tr> <td style="width:80%;">Series</td> <td style="text-align: right;">94 (4x)</td> </tr> <tr> <td></td> <td style="text-align: right;">280 (8x)</td> </tr> </table>	Series	94 (4x)		280 (8x)
1:	8.9	↗																																		
2:	9.5	←																																		
3:	9.6	↓																																		
4:	10.5x	↗																																		
5:	9.5	↗																																		
6:	9.4	↓																																		
7:	10.3	←																																		
8:	10.7x	↗																																		
9:	10.7x	↑																																		
10:	10.5x	↖																																		
Series	94 (4x)																																			
	280 (8x)																																			

Relay 2	Lane 9	Andreas Köppl
-------------------	------------------	----------------------

Mix Team Pistol Qual	GER 3	Mp	P
----------------------	-------	----	---

11.02.2026	Denmark Open Air 2026	Denmark Open Air 2026
------------	-----------------------	-----------------------

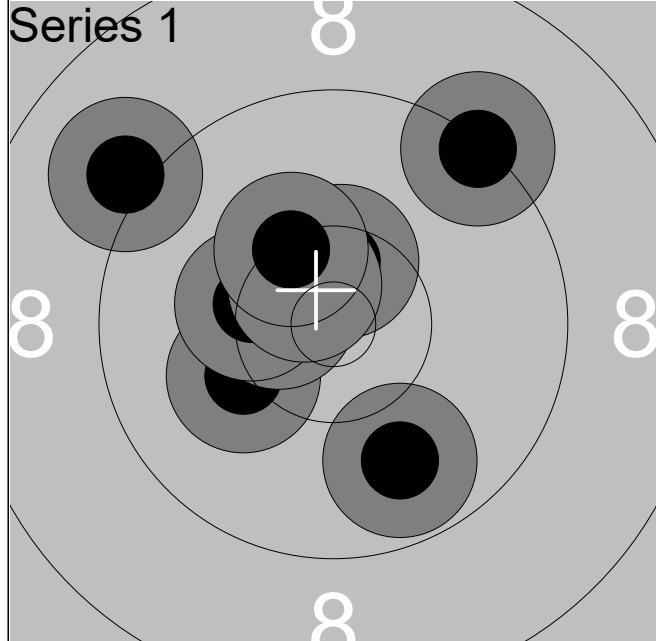

1:	9.1	↗
2:	10.6x	↗
3:	10.2	↖
4:	10.5x	↖
5:	9.3	↗
6:	10.3	↖
7:	10.5x	↑
8:	9.8	↓
9:	10.6x	↗
10:	10.3	↑

Series	97 (4x)
	97 (4x)

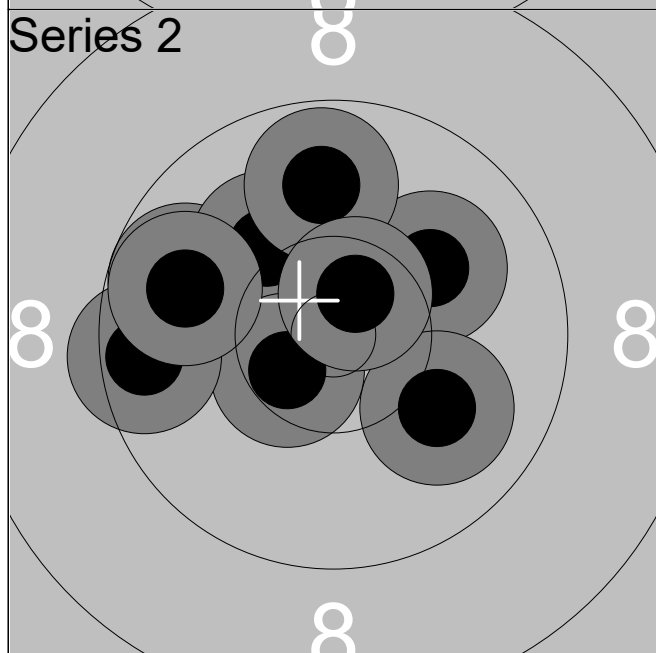

1:	10.6x	↑
2:	10.1	↗
3:	10.0	↓
4:	9.8	↖
5:	10.2	↗
6:	10.5x	↖
7:	9.8	↑
8:	10.6x	↗
9:	9.6	↖
10:	9.8	↖

Series	96 (3x)
	193 (7x)

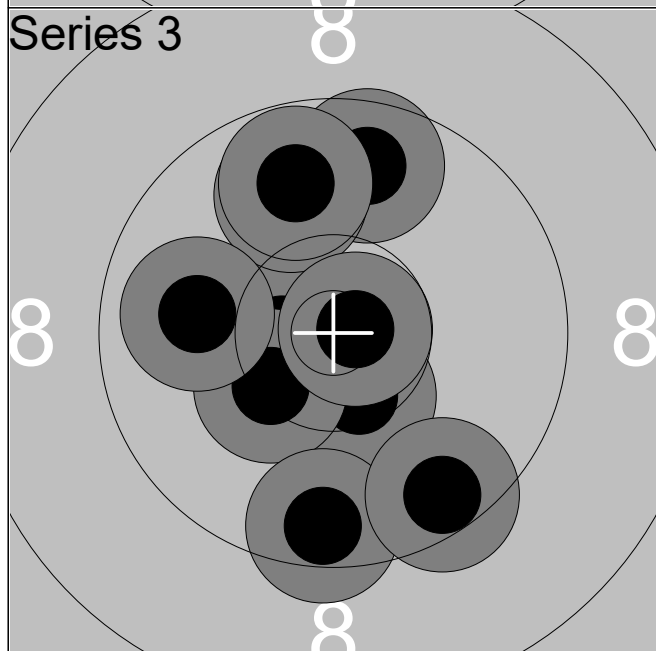

1:	10.6x	↖
2:	9.7	↑
3:	10.4x	↓
4:	10.4	↖
5:	9.9	↑
6:	9.8	↑
7:	9.5	↓
8:	9.5	↓
9:	10.8x	→
10:	9.9	↖

Series	94 (3x)
	287 (10x)

11.02.2026	Denmark Open Air 2026	Denmark Open Air 2026
------------	-----------------------	-----------------------

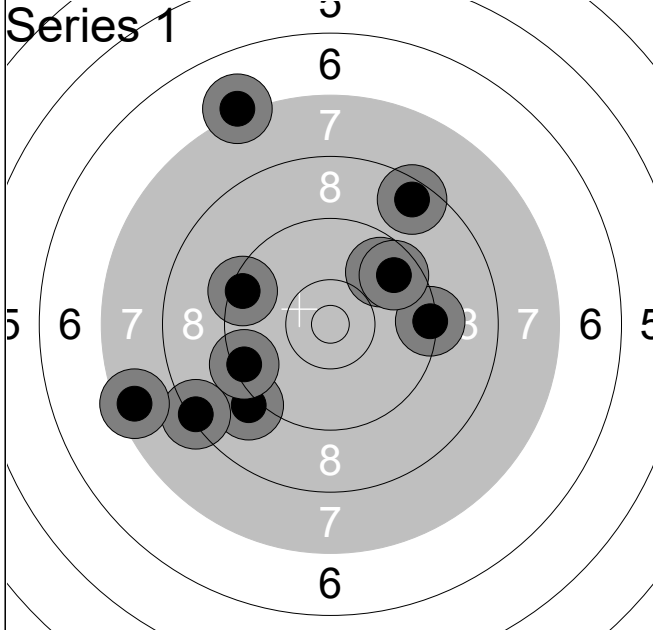
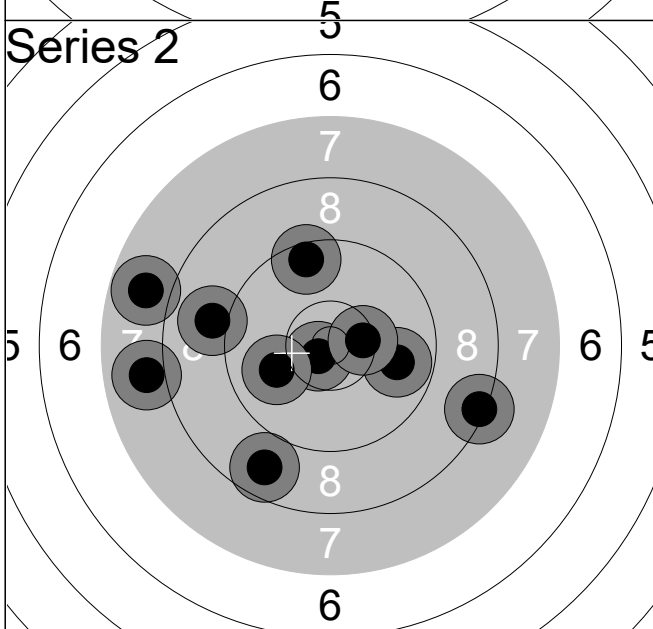
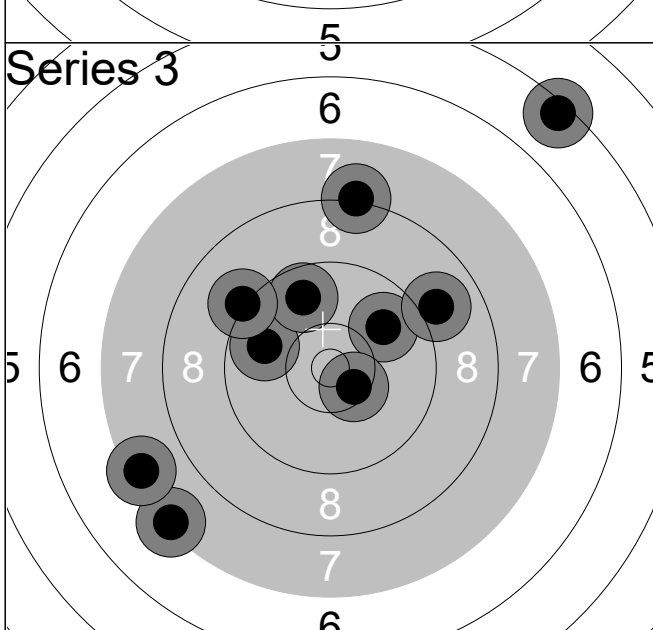
Series 1 	<table style="width:100%; border-collapse: collapse;"> <tr><td style="width:10%;">1:</td><td style="width:15%;">9.1</td><td style="width:10%; text-align: right;">↙</td></tr> <tr><td>2:</td><td>7.1</td><td style="text-align: right;">↑</td></tr> <tr><td>3:</td><td>9.3</td><td style="text-align: right;">→</td></tr> <tr><td>4:</td><td>9.4</td><td style="text-align: right;">↙</td></tr> <tr><td>5:</td><td>9.8</td><td style="text-align: right;">↗</td></tr> <tr><td>6:</td><td>9.4</td><td style="text-align: right;">↖</td></tr> <tr><td>7:</td><td>8.3</td><td style="text-align: right;">↙</td></tr> <tr><td>8:</td><td>9.6</td><td style="text-align: right;">↗</td></tr> <tr><td>9:</td><td>8.5</td><td style="text-align: right;">↗</td></tr> <tr><td>10:</td><td>7.5</td><td style="text-align: right;">↖</td></tr> <tr><td colspan="2">Series</td><td style="text-align: right;">84 (0x)</td></tr> <tr><td colspan="2"></td><td style="text-align: right;">84 (0x)</td></tr> </table>	1:	9.1	↙	2:	7.1	↑	3:	9.3	→	4:	9.4	↙	5:	9.8	↗	6:	9.4	↖	7:	8.3	↙	8:	9.6	↗	9:	8.5	↗	10:	7.5	↖	Series		84 (0x)			84 (0x)
1:	9.1	↙																																			
2:	7.1	↑																																			
3:	9.3	→																																			
4:	9.4	↙																																			
5:	9.8	↗																																			
6:	9.4	↖																																			
7:	8.3	↙																																			
8:	9.6	↗																																			
9:	8.5	↗																																			
10:	7.5	↖																																			
Series		84 (0x)																																			
		84 (0x)																																			
Series 2 	<table style="width:100%; border-collapse: collapse;"> <tr><td style="width:10%;">1:</td><td style="width:15%;">9.0</td><td style="width:10%; text-align: right;">↖</td></tr> <tr><td>2:</td><td>7.9</td><td style="text-align: right;">↖</td></tr> <tr><td>3:</td><td>9.5</td><td style="text-align: right;">↑</td></tr> <tr><td>4:</td><td>8.7</td><td style="text-align: right;">↘</td></tr> <tr><td>5:</td><td>10.7x</td><td style="text-align: right;">↙</td></tr> <tr><td>6:</td><td>9.8</td><td style="text-align: right;">→</td></tr> <tr><td>7:</td><td>10.0</td><td style="text-align: right;">↖</td></tr> <tr><td>8:</td><td>10.4x</td><td style="text-align: right;">→</td></tr> <tr><td>9:</td><td>8.3</td><td style="text-align: right;">→</td></tr> <tr><td>10:</td><td>7.8</td><td style="text-align: right;">↖</td></tr> <tr><td colspan="2">Series</td><td style="text-align: right;">87 (2x)</td></tr> <tr><td colspan="2"></td><td style="text-align: right;">171 (2x)</td></tr> </table>	1:	9.0	↖	2:	7.9	↖	3:	9.5	↑	4:	8.7	↘	5:	10.7x	↙	6:	9.8	→	7:	10.0	↖	8:	10.4x	→	9:	8.3	→	10:	7.8	↖	Series		87 (2x)			171 (2x)
1:	9.0	↖																																			
2:	7.9	↖																																			
3:	9.5	↑																																			
4:	8.7	↘																																			
5:	10.7x	↙																																			
6:	9.8	→																																			
7:	10.0	↖																																			
8:	10.4x	→																																			
9:	8.3	→																																			
10:	7.8	↖																																			
Series		87 (2x)																																			
		171 (2x)																																			
Series 3 	<table style="width:100%; border-collapse: collapse;"> <tr><td style="width:10%;">1:</td><td style="width:15%;">7.3</td><td style="width:10%; text-align: right;">↙</td></tr> <tr><td>2:</td><td>8.2</td><td style="text-align: right;">↑</td></tr> <tr><td>3:</td><td>9.9</td><td style="text-align: right;">↗</td></tr> <tr><td>4:</td><td>9.8</td><td style="text-align: right;">↖</td></tr> <tr><td>5:</td><td>9.7</td><td style="text-align: right;">↑</td></tr> <tr><td>6:</td><td>9.2</td><td style="text-align: right;">↖</td></tr> <tr><td>7:</td><td>5.4</td><td style="text-align: right;">↗</td></tr> <tr><td>8:</td><td>9.0</td><td style="text-align: right;">↗</td></tr> <tr><td>9:</td><td>10.5x</td><td style="text-align: right;">↘</td></tr> <tr><td>10:</td><td>7.5</td><td style="text-align: right;">↖</td></tr> <tr><td colspan="2">Series</td><td style="text-align: right;">82 (1x)</td></tr> <tr><td colspan="2"></td><td style="text-align: right;">253 (3x)</td></tr> </table>	1:	7.3	↙	2:	8.2	↑	3:	9.9	↗	4:	9.8	↖	5:	9.7	↑	6:	9.2	↖	7:	5.4	↗	8:	9.0	↗	9:	10.5x	↘	10:	7.5	↖	Series		82 (1x)			253 (3x)
1:	7.3	↙																																			
2:	8.2	↑																																			
3:	9.9	↗																																			
4:	9.8	↖																																			
5:	9.7	↑																																			
6:	9.2	↖																																			
7:	5.4	↗																																			
8:	9.0	↗																																			
9:	10.5x	↘																																			
10:	7.5	↖																																			
Series		82 (1x)																																			
		253 (3x)																																			

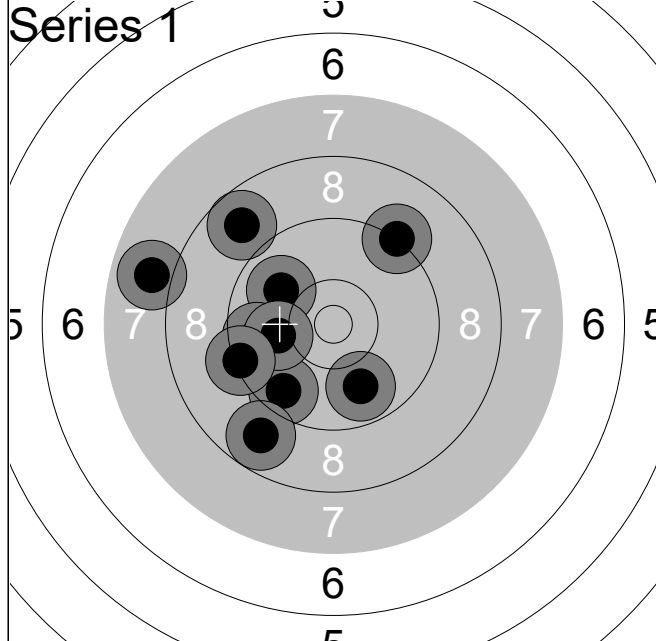

1:	8.8	↗
2:	9.9	↖
3:	9.2	↗
4:	9.7	←
5:	7.9	←
6:	9.6	↘
7:	8.8	↘
8:	10.0	←
9:	9.3	←
10:	9.9	↓
Series		87 (0x)
		87 (0x)

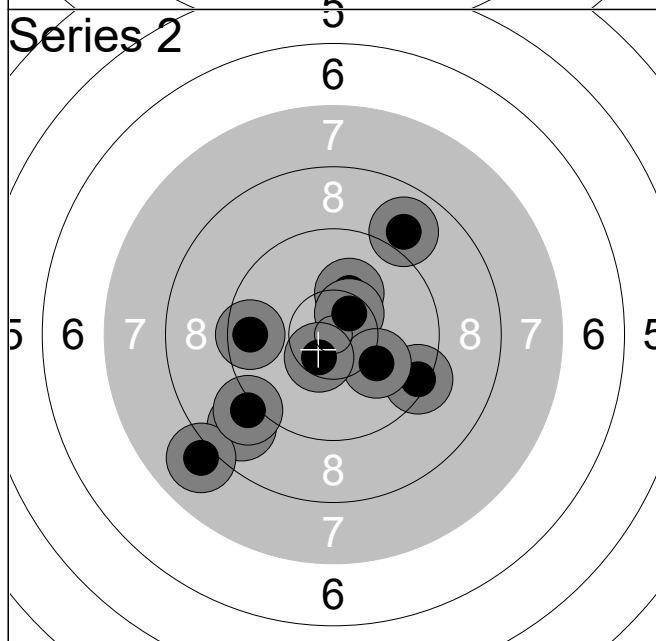

1:	8.8	↘
2:	10.2	↗
3:	10.5x	↗
4:	9.4	⇒
5:	9.6	←
6:	10.1	⇒
7:	8.0	↘
8:	9.1	↘
9:	10.5x	↘
10:	8.9	↗
Series		91 (2x)
		178 (2x)

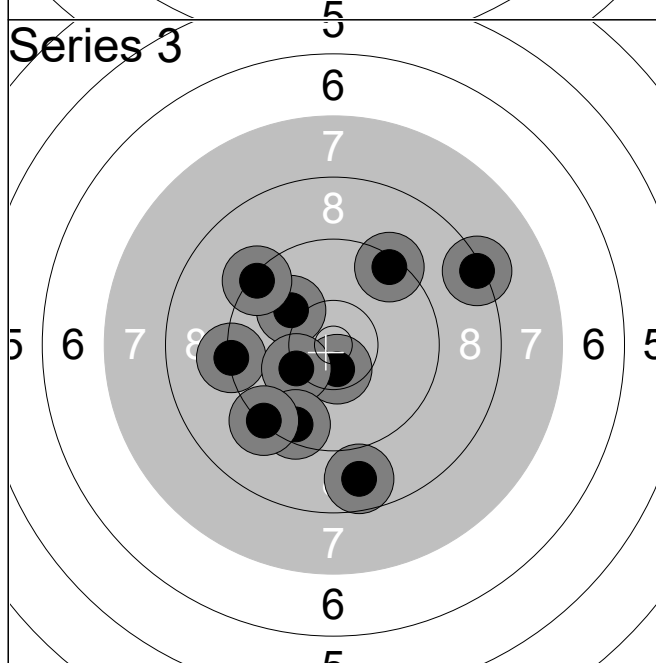

1:	10.6x	↓
2:	9.3	←
3:	10.1	↗
4:	8.3	↗
5:	10.2	←
6:	9.5	↘
7:	9.3	↘
8:	9.4	↗
9:	9.3	↗
10:	8.7	↓
Series		91 (1x)
		269 (3x)

Relay 2	Lane 12	Susanne Neisinger
-------------------	-------------------	--------------------------

Mix Team Pistol Qual	GER 2	Wp	P
----------------------	-------	----	---

11.02.2026	Denmark Open Air 2026	Denmark Open Air 2026
------------	-----------------------	-----------------------

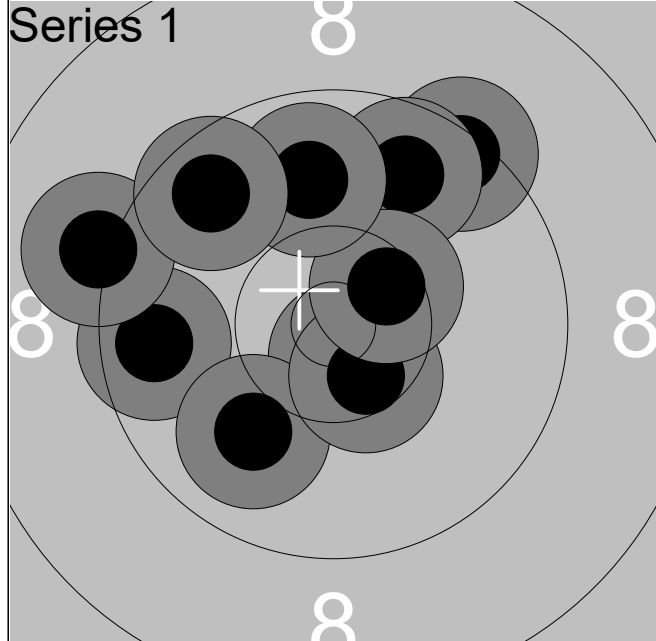

1:	10.7x	↓
2:	9.4	↗
3:	9.6	←
4:	9.1	↖
5:	10.0	↙
6:	9.7	↗
7:	10.5x	↓
8:	10.5x	↗
9:	9.9	↑
10:	9.6	↖

Series	94 (3x)
	94 (3x)

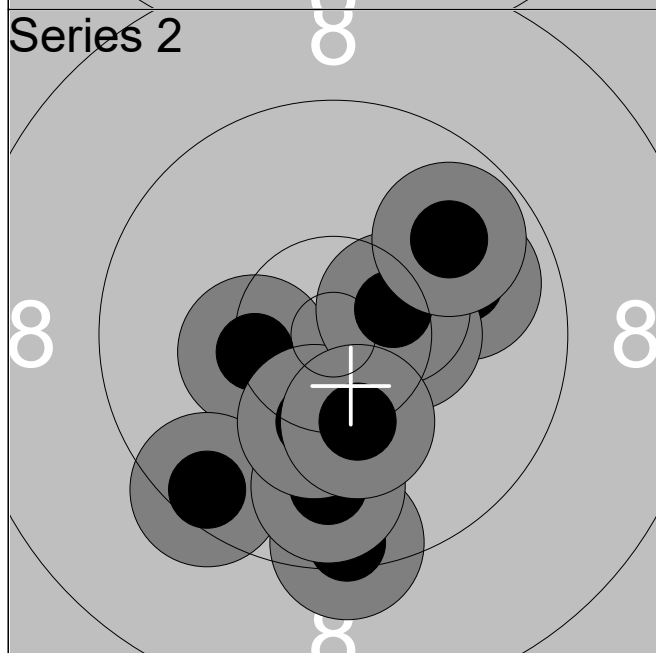

1:	10.4x	←
2:	9.5	↙
3:	9.4	↓
4:	9.8	↓
5:	10.3	↓
6:	9.9	↗
7:	10.4x	→
8:	10.5x	↗
9:	10.3	↓
10:	9.8	↗

Series	95 (3x)
	189 (6x)

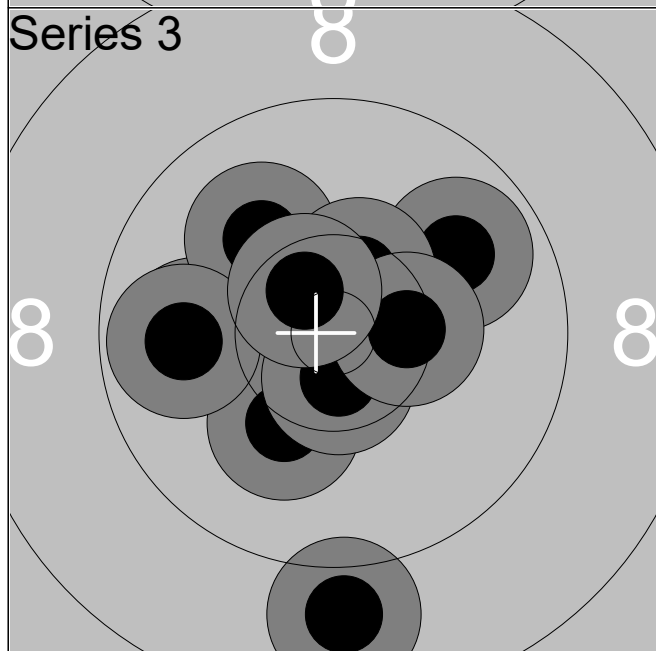

1:	8.9	↓
2:	10.0	←
3:	9.9	↗
4:	10.1	↖
5:	10.2	↙
6:	9.8	←
7:	10.6x	↓
8:	10.5x	↗
9:	10.4x	→
10:	10.6x	↖

Series	96 (4x)
	285 (10x)

Relay 2	Lane 13	Paul Frölich
-------------------	-------------------	---------------------

Mix Team Pistol Qual	GER	Mp	P
----------------------	-----	----	---

11.02.2026	Denmark Open Air 2026	Denmark Open Air 2026
------------	-----------------------	-----------------------

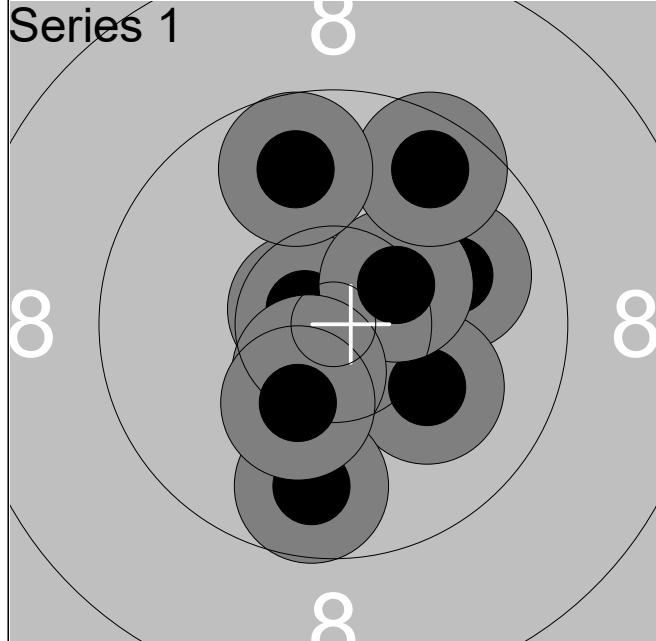

1:	10.4x	→
2:	10.0	→
3:	10.7x	↖
4:	10.1	↘
5:	10.4x	→
6:	10.6x	↙
7:	9.6	↗
8:	9.7	↘
9:	9.8	↑
10:	10.3	↘

Series	97 (4x)
	97 (4x)

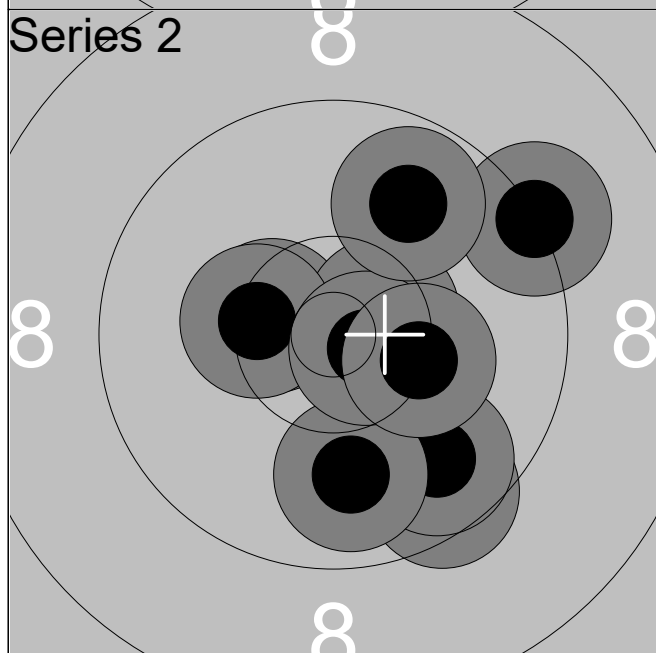

1:	9.3	↗
2:	10.5x	↖
3:	9.5	↘
4:	10.6x	→
5:	10.4x	↖
6:	9.8	↘
7:	9.9	↘
8:	10.7x	→
9:	10.3	→
10:	9.8	↗

Series	95 (4x)
	192 (8x)

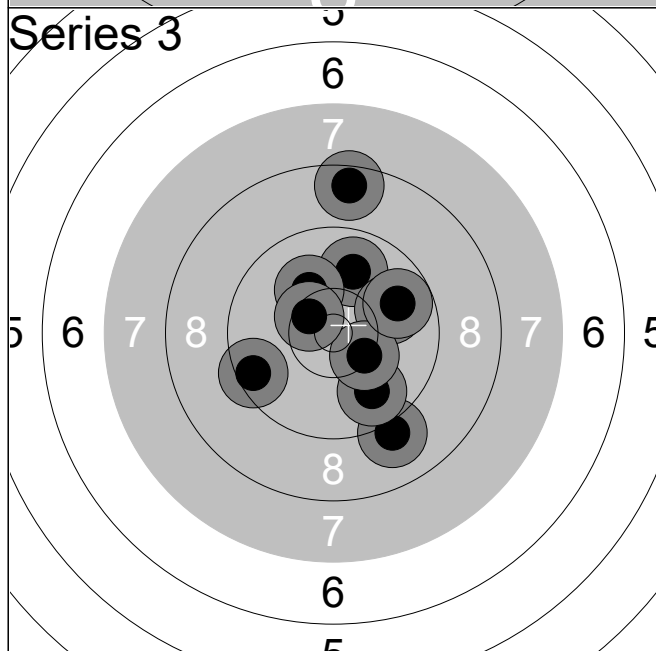

1:	9.9	↑
2:	9.1	↘
3:	9.5	↖
4:	10.1	↗
5:	8.6	↑
6:	9.8	↘
7:	10.0	→
8:	10.3	↘
9:	10.5x	↗
10:	9.8	→

Series	93 (1x)
	285 (9x)

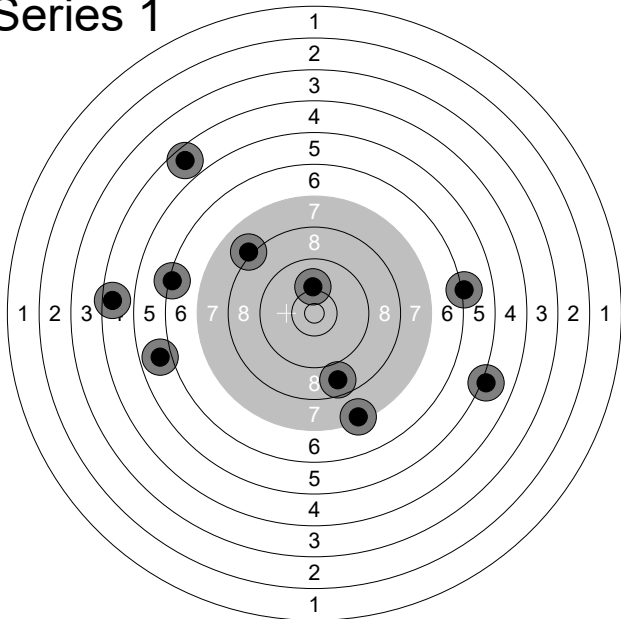
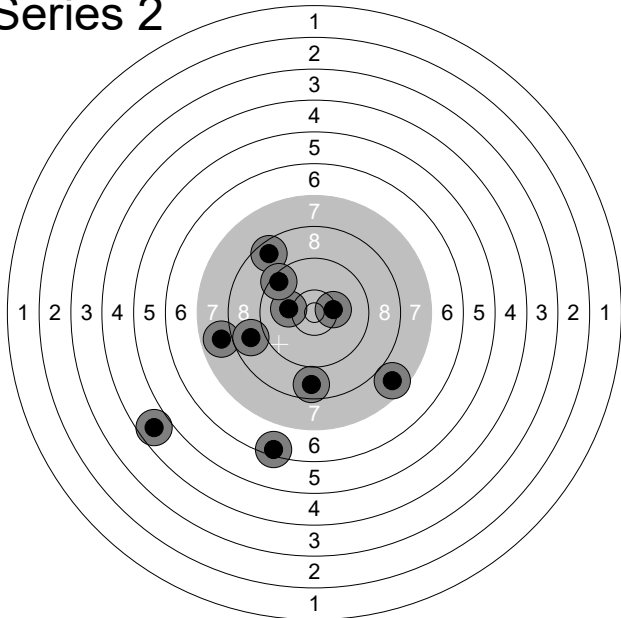
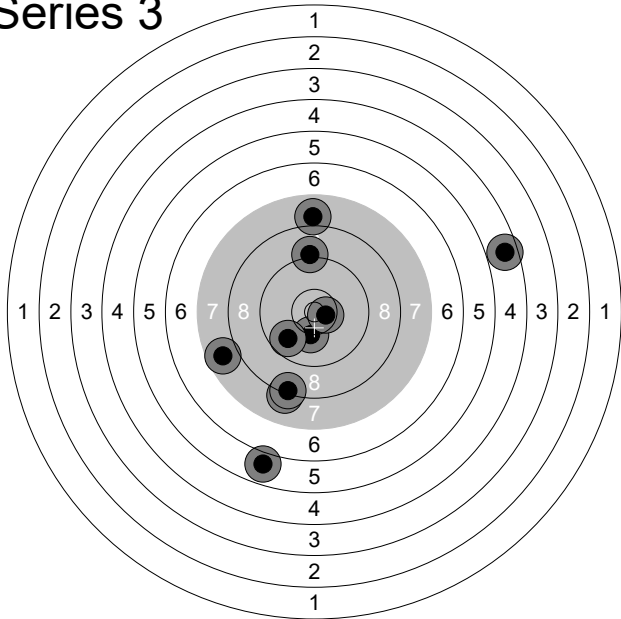
11.02.2026	Denmark Open Air 2026	Denmark Open Air 2026																													
Series 1 	<table style="width:100%; border-collapse: collapse;"> <tr><td>1:</td><td>4.6</td><td>↗</td></tr> <tr><td>2:</td><td>6.3</td><td>↖</td></tr> <tr><td>3:</td><td>5.1</td><td>↘</td></tr> <tr><td>4:</td><td>5.9</td><td>↖</td></tr> <tr><td>5:</td><td>6.1</td><td>→</td></tr> <tr><td>6:</td><td>10.1</td><td>↑</td></tr> <tr><td>7:</td><td>8.1</td><td>↗</td></tr> <tr><td>8:</td><td>7.4</td><td>↘</td></tr> <tr><td>9:</td><td>8.7</td><td>↘</td></tr> <tr><td>10:</td><td>4.6</td><td>↖</td></tr> </table>	1:	4.6	↗	2:	6.3	↖	3:	5.1	↘	4:	5.9	↖	5:	6.1	→	6:	10.1	↑	7:	8.1	↗	8:	7.4	↘	9:	8.7	↘	10:	4.6	↖
1:	4.6	↗																													
2:	6.3	↖																													
3:	5.1	↘																													
4:	5.9	↖																													
5:	6.1	→																													
6:	10.1	↑																													
7:	8.1	↗																													
8:	7.4	↘																													
9:	8.7	↘																													
10:	4.6	↖																													
Series		63 (0x)																													
		63 (0x)																													
Series 2 	<table style="width:100%; border-collapse: collapse;"> <tr><td>1:</td><td>8.7</td><td>↓</td></tr> <tr><td>2:</td><td>4.7</td><td>↖</td></tr> <tr><td>3:</td><td>10.1</td><td>↖</td></tr> <tr><td>4:</td><td>10.3</td><td>→</td></tr> <tr><td>5:</td><td>7.7</td><td>↘</td></tr> <tr><td>6:</td><td>8.6</td><td>↗</td></tr> <tr><td>7:</td><td>6.4</td><td>↘</td></tr> <tr><td>8:</td><td>9.5</td><td>↗</td></tr> <tr><td>9:</td><td>7.9</td><td>↖</td></tr> <tr><td>10:</td><td>8.8</td><td>↖</td></tr> </table>	1:	8.7	↓	2:	4.7	↖	3:	10.1	↖	4:	10.3	→	5:	7.7	↘	6:	8.6	↗	7:	6.4	↘	8:	9.5	↗	9:	7.9	↖	10:	8.8	↖
1:	8.7	↓																													
2:	4.7	↖																													
3:	10.1	↖																													
4:	10.3	→																													
5:	7.7	↘																													
6:	8.6	↗																													
7:	6.4	↘																													
8:	9.5	↗																													
9:	7.9	↖																													
10:	8.8	↖																													
Series		77 (0x)																													
		140 (0x)																													
Series 3 	<table style="width:100%; border-collapse: collapse;"> <tr><td>1:</td><td>10.2</td><td>↓</td></tr> <tr><td>2:</td><td>10.6x</td><td>→</td></tr> <tr><td>3:</td><td>7.7</td><td>↖</td></tr> <tr><td>4:</td><td>8.2</td><td>↘</td></tr> <tr><td>5:</td><td>9.1</td><td>↑</td></tr> <tr><td>6:</td><td>9.8</td><td>↖</td></tr> <tr><td>7:</td><td>4.6</td><td>→</td></tr> <tr><td>8:</td><td>8.3</td><td>↘</td></tr> <tr><td>9:</td><td>5.9</td><td>↘</td></tr> <tr><td>10:</td><td>7.9</td><td>↑</td></tr> </table>	1:	10.2	↓	2:	10.6x	→	3:	7.7	↖	4:	8.2	↘	5:	9.1	↑	6:	9.8	↖	7:	4.6	→	8:	8.3	↘	9:	5.9	↘	10:	7.9	↑
1:	10.2	↓																													
2:	10.6x	→																													
3:	7.7	↖																													
4:	8.2	↘																													
5:	9.1	↑																													
6:	9.8	↖																													
7:	4.6	→																													
8:	8.3	↘																													
9:	5.9	↘																													
10:	7.9	↑																													
Series		77 (1x)																													
		217 (1x)																													

11.02.2026	Denmark Open Air 2026	Denmark Open Air 2026
------------	-----------------------	-----------------------

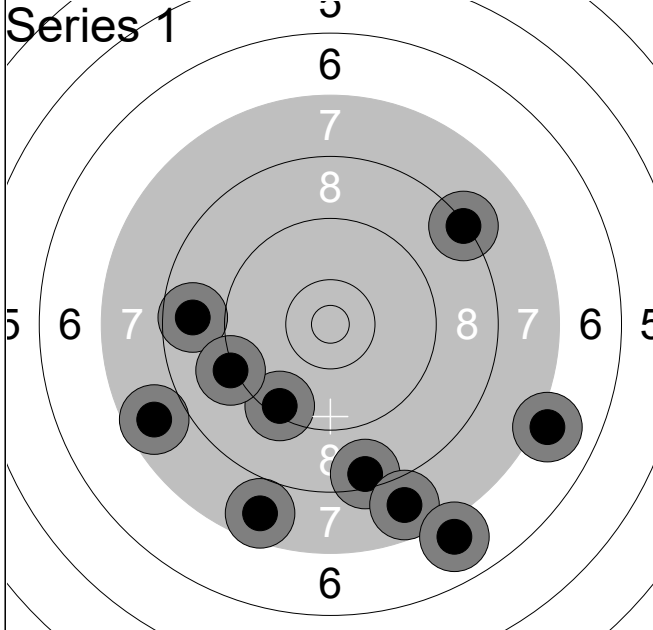
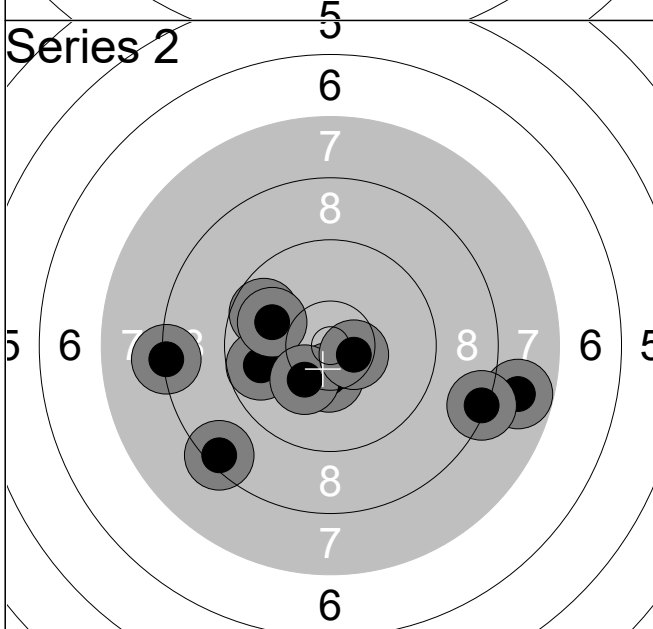
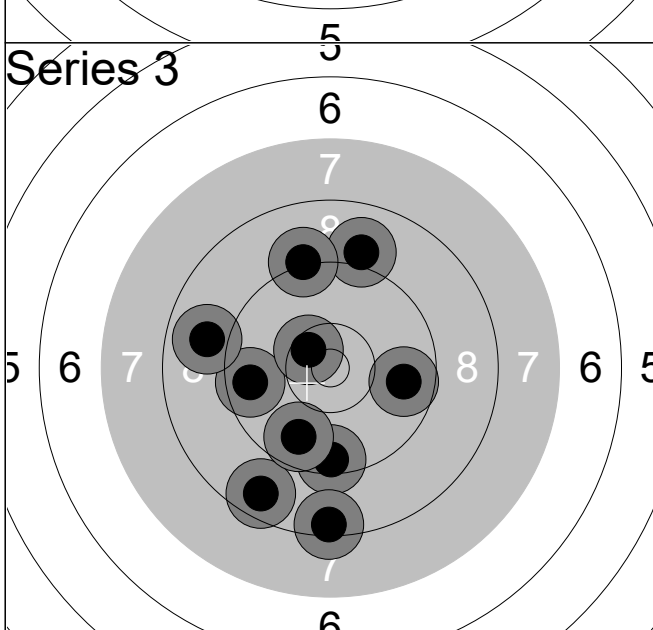
Series 1 	<table style="width:100%; border-collapse: collapse;"> <tr><td style="width:5%;">1:</td><td style="width:15%;">7.7</td><td style="width:10%; text-align: right;">↓</td></tr> <tr><td>2:</td><td>8.7</td><td style="text-align: right;">←</td></tr> <tr><td>3:</td><td>9.4</td><td style="text-align: right;">↓</td></tr> <tr><td>4:</td><td>7.0</td><td style="text-align: right;">→</td></tr> <tr><td>5:</td><td>9.2</td><td style="text-align: right;">←</td></tr> <tr><td>6:</td><td>8.5</td><td style="text-align: right;">↓</td></tr> <tr><td>7:</td><td>8.3</td><td style="text-align: right;">↗</td></tr> <tr><td>8:</td><td>7.7</td><td style="text-align: right;">←</td></tr> <tr><td>9:</td><td>7.8</td><td style="text-align: right;">↓</td></tr> <tr><td>10:</td><td>7.0</td><td style="text-align: right;">↓</td></tr> <tr><td colspan="2" style="text-align: right;">Series</td><td style="text-align: right;">77 (0x)</td></tr> <tr><td colspan="2"></td><td style="text-align: right;">77 (0x)</td></tr> </table>	1:	7.7	↓	2:	8.7	←	3:	9.4	↓	4:	7.0	→	5:	9.2	←	6:	8.5	↓	7:	8.3	↗	8:	7.7	←	9:	7.8	↓	10:	7.0	↓	Series		77 (0x)			77 (0x)
1:	7.7	↓																																			
2:	8.7	←																																			
3:	9.4	↓																																			
4:	7.0	→																																			
5:	9.2	←																																			
6:	8.5	↓																																			
7:	8.3	↗																																			
8:	7.7	←																																			
9:	7.8	↓																																			
10:	7.0	↓																																			
Series		77 (0x)																																			
		77 (0x)																																			
Series 2 	<table style="width:100%; border-collapse: collapse;"> <tr><td style="width:5%;">1:</td><td style="width:15%;">7.8</td><td style="width:10%; text-align: right;">→</td></tr> <tr><td>2:</td><td>9.8</td><td style="text-align: right;">↖</td></tr> <tr><td>3:</td><td>8.4</td><td style="text-align: right;">↓</td></tr> <tr><td>4:</td><td>10.4x</td><td style="text-align: right;">↓</td></tr> <tr><td>5:</td><td>9.8</td><td style="text-align: right;">←</td></tr> <tr><td>6:</td><td>8.3</td><td style="text-align: right;">→</td></tr> <tr><td>7:</td><td>8.3</td><td style="text-align: right;">←</td></tr> <tr><td>8:</td><td>9.9</td><td style="text-align: right;">↖</td></tr> <tr><td>9:</td><td>10.3</td><td style="text-align: right;">↓</td></tr> <tr><td>10:</td><td>10.5x</td><td style="text-align: right;">→</td></tr> <tr><td colspan="2" style="text-align: right;">Series</td><td style="text-align: right;">88 (2x)</td></tr> <tr><td colspan="2"></td><td style="text-align: right;">165 (2x)</td></tr> </table>	1:	7.8	→	2:	9.8	↖	3:	8.4	↓	4:	10.4x	↓	5:	9.8	←	6:	8.3	→	7:	8.3	←	8:	9.9	↖	9:	10.3	↓	10:	10.5x	→	Series		88 (2x)			165 (2x)
1:	7.8	→																																			
2:	9.8	↖																																			
3:	8.4	↓																																			
4:	10.4x	↓																																			
5:	9.8	←																																			
6:	8.3	→																																			
7:	8.3	←																																			
8:	9.9	↖																																			
9:	10.3	↓																																			
10:	10.5x	→																																			
Series		88 (2x)																																			
		165 (2x)																																			
Series 3 	<table style="width:100%; border-collapse: collapse;"> <tr><td style="width:5%;">1:</td><td style="width:15%;">9.5</td><td style="width:10%; text-align: right;">↓</td></tr> <tr><td>2:</td><td>9.0</td><td style="text-align: right;">↑</td></tr> <tr><td>3:</td><td>9.6</td><td style="text-align: right;">←</td></tr> <tr><td>4:</td><td>10.5x</td><td style="text-align: right;">↗</td></tr> <tr><td>5:</td><td>9.2</td><td style="text-align: right;">↑</td></tr> <tr><td>6:</td><td>8.6</td><td style="text-align: right;">↓</td></tr> <tr><td>7:</td><td>9.7</td><td style="text-align: right;">↓</td></tr> <tr><td>8:</td><td>9.7</td><td style="text-align: right;">→</td></tr> <tr><td>9:</td><td>8.9</td><td style="text-align: right;">←</td></tr> <tr><td>10:</td><td>8.4</td><td style="text-align: right;">↓</td></tr> <tr><td colspan="2" style="text-align: right;">Series</td><td style="text-align: right;">88 (1x)</td></tr> <tr><td colspan="2"></td><td style="text-align: right;">253 (3x)</td></tr> </table>	1:	9.5	↓	2:	9.0	↑	3:	9.6	←	4:	10.5x	↗	5:	9.2	↑	6:	8.6	↓	7:	9.7	↓	8:	9.7	→	9:	8.9	←	10:	8.4	↓	Series		88 (1x)			253 (3x)
1:	9.5	↓																																			
2:	9.0	↑																																			
3:	9.6	←																																			
4:	10.5x	↗																																			
5:	9.2	↑																																			
6:	8.6	↓																																			
7:	9.7	↓																																			
8:	9.7	→																																			
9:	8.9	←																																			
10:	8.4	↓																																			
Series		88 (1x)																																			
		253 (3x)																																			

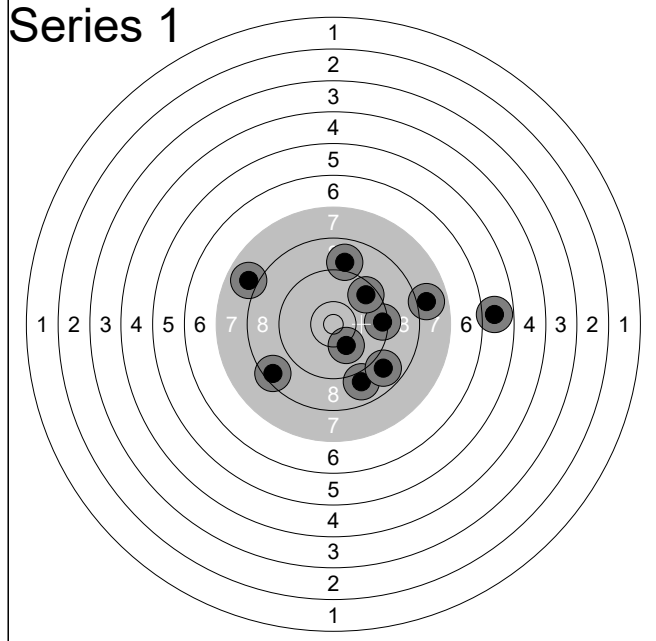

1:	7.9	→
2:	10.2	↓
3:	5.8	→
4:	8.9	↓
5:	9.4	→
6:	8.5	↙
7:	9.0	↑
8:	8.8	↓
9:	9.6	↗
10:	7.9	↖
Series		80 (0x)
		80 (0x)

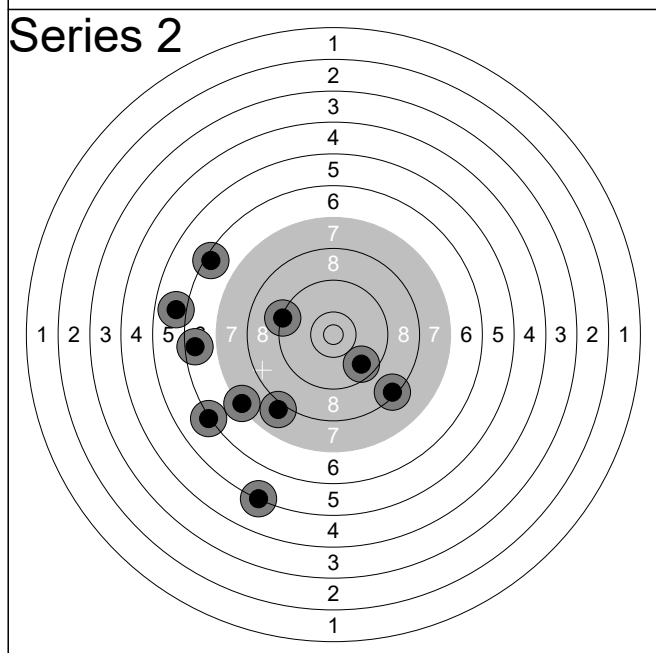

1:	6.5	←
2:	9.3	←
3:	9.7	↓
4:	8.3	↓
5:	5.2	↓
6:	6.4	↗
7:	6.2	↙
8:	7.3	↙
9:	8.0	↓
10:	5.9	←
Series		69 (0x)
		149 (0x)

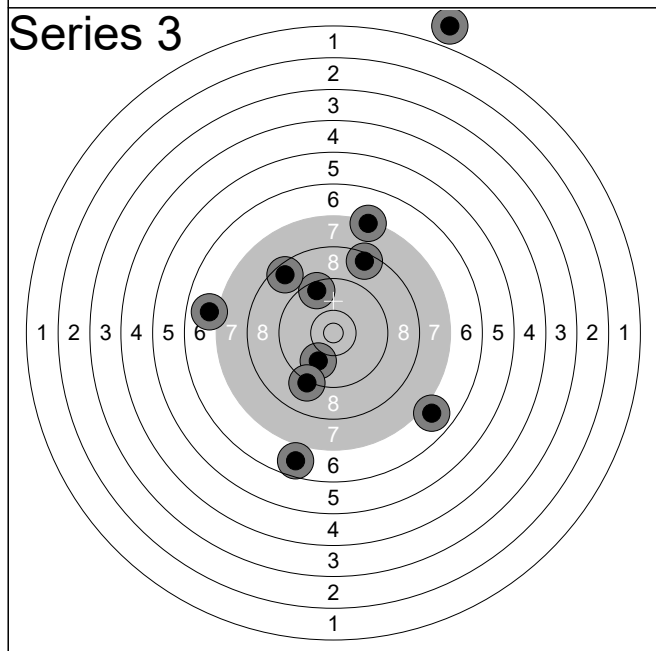

1:	6.9	↘
2:	7.3	↑
3:	10.0	↓
4:	9.5	↑
5:	0.0	↑
6:	9.2	↓
7:	6.7	↓
8:	8.5	↑
9:	8.5	↗
10:	7.0	←
Series		70 (0x)
		219 (0x)

11.02.2026	Denmark Open Air 2026	Denmark Open Air 2026	
Series 1 	1:	7.8	↖
	2:	6.5	↙
	3:	7.2	↑
	4:	10.2	↗
	5:	10.7x	↓
	6:	9.1	↙
	7:	9.8	↗
	8:	10.2	↘
	9:	7.2	↙
	10:	8.4	↑
Series		83 (1x)	
		83 (1x)	
Series 2 	1:	9.2	↙
	2:	9.1	↑
	3:	9.3	↙
	4:	9.2	↓
	5:	7.2	↗
	6:	9.0	↑
	7:	9.4	↙
	8:	5.1	↑
	9:	6.5	↙
	10:	8.0	↘
Series		80 (0x)	
		163 (1x)	
Series 3 	1:	9.6	↙
	2:	10.6x	↙
	3:	9.2	↙
	4:	6.8	→
	5:	8.9	↙
	6:	9.6	↙
	7:	10.7x	↗
	8:	9.9	↘
	9:	10.2	↙
	10:	8.2	→
Series		88 (2x)	
		251 (3x)	

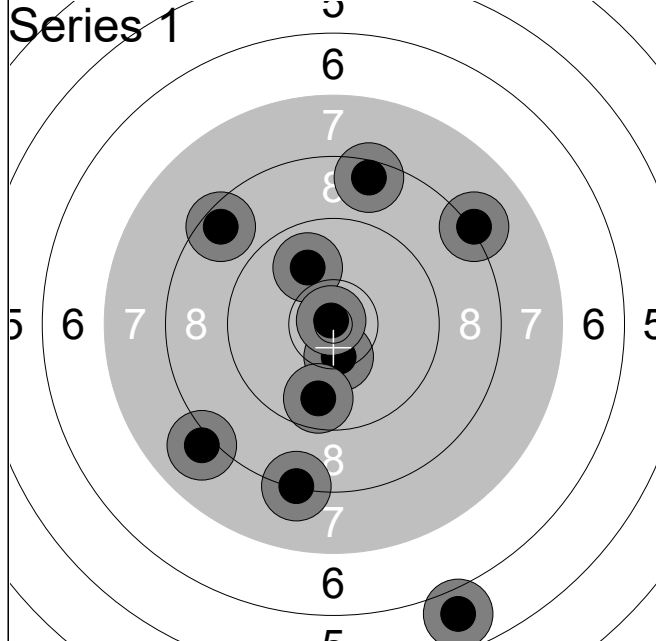

1:	8.5	↗
2:	9.9	↗
3:	10.4x	↓
4:	8.2	↗
5:	8.3	↓
6:	8.5	↗
7:	10.9x	↗
8:	9.7	↓
9:	8.1	↙
10:	5.8	↓
Series		83 (2x)
		83 (2x)

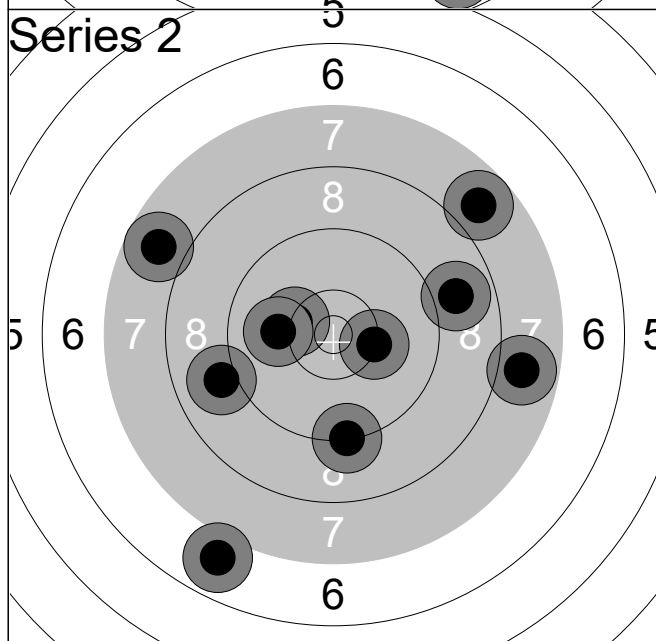

1:	9.3	↓
2:	6.9	↓
3:	9.0	←
4:	7.8	→
5:	10.3	→
6:	8.9	→
7:	7.8	↖
8:	10.3	←
9:	7.8	↗
10:	10.0	←
Series		83 (0x)
		166 (2x)

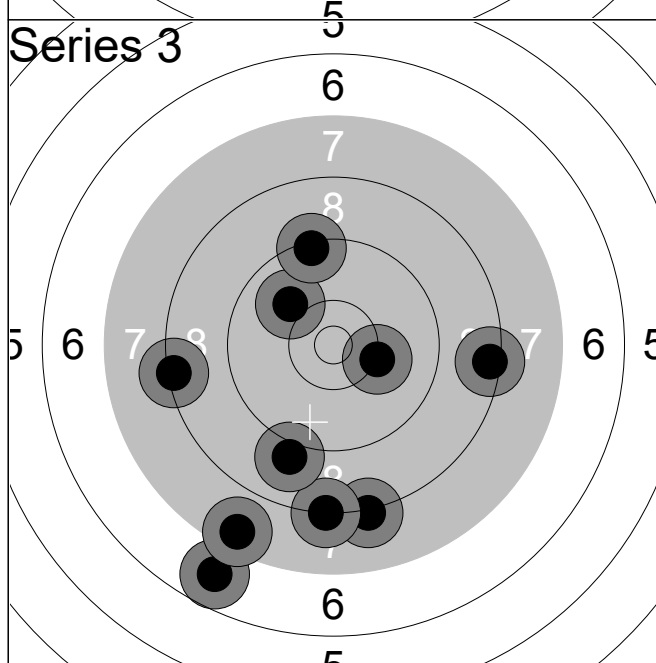

1:	8.2	↓
2:	10.0	↗
3:	10.2	→
4:	6.8	↓
5:	8.4	→
6:	8.2	↓
7:	7.5	↓
8:	8.3	←
9:	9.0	↓
10:	9.3	↗
Series		83 (0x)
		249 (2x)

Relay 2	Lane 19	Buster Antonsen
-------------------	-------------------	------------------------

Mix Team Pistol Qual	DEN 6	Mp	P
----------------------	-------	----	---

11.02.2026	Denmark Open Air 2026	Denmark Open Air 2026
------------	-----------------------	-----------------------

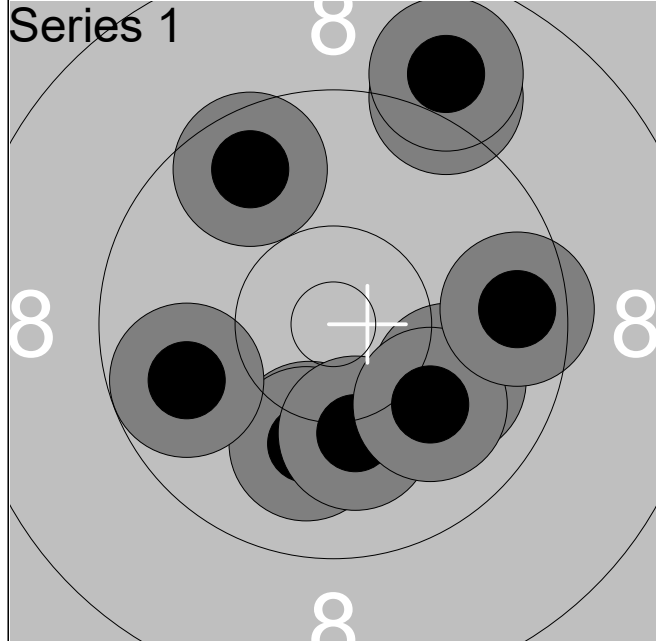

1:	10.1	↓
2:	9.1	↗
3:	10.1	↓
4:	10.0	→
5:	10.1	↓
6:	9.7	↗
7:	10.0	↘
8:	9.6	→
9:	9.8	↖
10:	8.9	↗

Series	94 (0x)
	94 (0x)

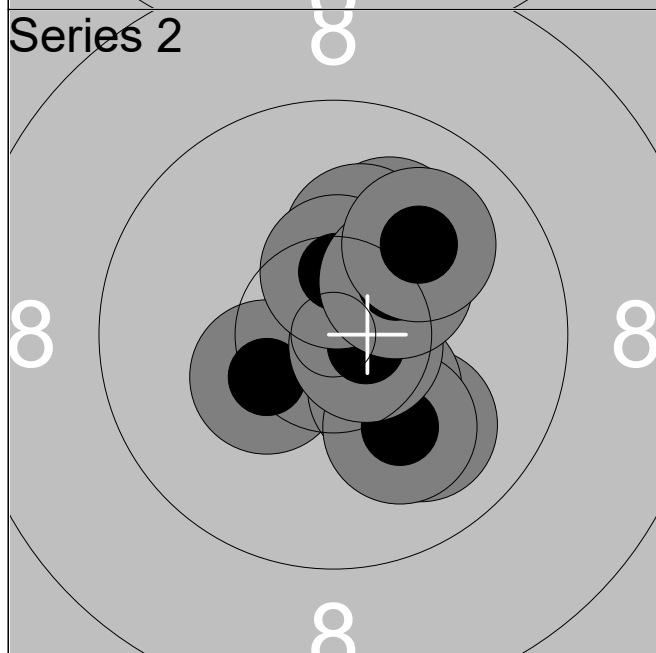

1:	10.4x	↖
2:	10.0	↘
3:	10.4x	↘
4:	10.1	↘
5:	10.1	↗
6:	10.7x	→
7:	10.2	↗
8:	10.5x	↑
9:	10.3	↗
10:	10.0	↗

Series	100 (4x)
	194 (4x)

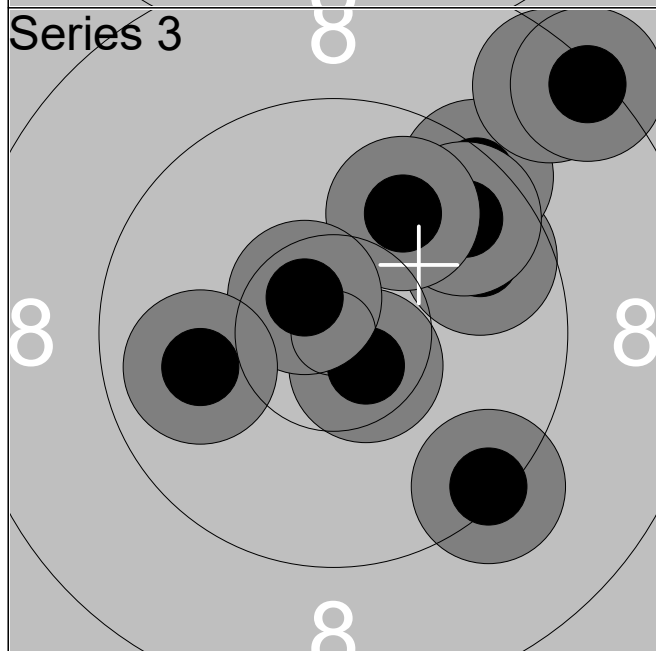

1:	9.3	↘
2:	9.7	↗
3:	9.4	↗
4:	10.6x	↘
5:	8.5	↗
6:	9.7	↗
7:	9.9	↗
8:	10.6x	↖
9:	8.3	↗
10:	9.9	↖

Series	90 (2x)
	284 (6x)

11.02.2026	Denmark Open Air 2026	Denmark Open Air 2026
------------	-----------------------	-----------------------

<p>Series 1</p>	<table style="width:100%; border-collapse: collapse;"> <tr><td style="width:10%;">1:</td><td style="width:20%;">10.1</td><td style="width:10%; text-align: center;">↓</td></tr> <tr><td>2:</td><td>10.0</td><td style="text-align: center;">↑</td></tr> <tr><td>3:</td><td>7.9</td><td style="text-align: center;">↙</td></tr> <tr><td>4:</td><td>8.0</td><td style="text-align: center;">↓</td></tr> <tr><td>5:</td><td>8.7</td><td style="text-align: center;">↖</td></tr> <tr><td>6:</td><td>8.5</td><td style="text-align: center;">↙</td></tr> <tr><td>7:</td><td>10.0</td><td style="text-align: center;">↑</td></tr> <tr><td>8:</td><td>9.1</td><td style="text-align: center;">↑</td></tr> <tr><td>9:</td><td>8.8</td><td style="text-align: center;">↑</td></tr> <tr><td>10:</td><td>9.8</td><td style="text-align: center;">↑</td></tr> <tr><td colspan="2">Series</td><td style="text-align: right;">87 (0x)</td></tr> <tr><td colspan="2"></td><td style="text-align: right;">87 (0x)</td></tr> </table>	1:	10.1	↓	2:	10.0	↑	3:	7.9	↙	4:	8.0	↓	5:	8.7	↖	6:	8.5	↙	7:	10.0	↑	8:	9.1	↑	9:	8.8	↑	10:	9.8	↑	Series		87 (0x)			87 (0x)
1:	10.1	↓																																			
2:	10.0	↑																																			
3:	7.9	↙																																			
4:	8.0	↓																																			
5:	8.7	↖																																			
6:	8.5	↙																																			
7:	10.0	↑																																			
8:	9.1	↑																																			
9:	8.8	↑																																			
10:	9.8	↑																																			
Series		87 (0x)																																			
		87 (0x)																																			
<p>Series 2</p>	<table style="width:100%; border-collapse: collapse;"> <tr><td style="width:10%;">1:</td><td style="width:20%;">9.6</td><td style="width:10%; text-align: center;">↓</td></tr> <tr><td>2:</td><td>7.8</td><td style="text-align: center;">↑</td></tr> <tr><td>3:</td><td>8.9</td><td style="text-align: center;">↗</td></tr> <tr><td>4:</td><td>7.7</td><td style="text-align: center;">↘</td></tr> <tr><td>5:</td><td>10.1</td><td style="text-align: center;">↙</td></tr> <tr><td>6:</td><td>7.9</td><td style="text-align: center;">↑</td></tr> <tr><td>7:</td><td>8.9</td><td style="text-align: center;">↑</td></tr> <tr><td>8:</td><td>7.9</td><td style="text-align: center;">→</td></tr> <tr><td>9:</td><td>7.8</td><td style="text-align: center;">↑</td></tr> <tr><td>10:</td><td>9.1</td><td style="text-align: center;">↑</td></tr> <tr><td colspan="2">Series</td><td style="text-align: right;">79 (0x)</td></tr> <tr><td colspan="2"></td><td style="text-align: right;">166 (0x)</td></tr> </table>	1:	9.6	↓	2:	7.8	↑	3:	8.9	↗	4:	7.7	↘	5:	10.1	↙	6:	7.9	↑	7:	8.9	↑	8:	7.9	→	9:	7.8	↑	10:	9.1	↑	Series		79 (0x)			166 (0x)
1:	9.6	↓																																			
2:	7.8	↑																																			
3:	8.9	↗																																			
4:	7.7	↘																																			
5:	10.1	↙																																			
6:	7.9	↑																																			
7:	8.9	↑																																			
8:	7.9	→																																			
9:	7.8	↑																																			
10:	9.1	↑																																			
Series		79 (0x)																																			
		166 (0x)																																			
<p>Series 3</p>	<table style="width:100%; border-collapse: collapse;"> <tr><td style="width:10%;">1:</td><td style="width:20%;">9.7</td><td style="width:10%; text-align: center;">↓</td></tr> <tr><td>2:</td><td>10.1</td><td style="text-align: center;">↓</td></tr> <tr><td>3:</td><td>9.6</td><td style="text-align: center;">↙</td></tr> <tr><td>4:</td><td>10.7x</td><td style="text-align: center;">↓</td></tr> <tr><td>5:</td><td>6.6</td><td style="text-align: center;">↑</td></tr> <tr><td>6:</td><td>7.6</td><td style="text-align: center;">↘</td></tr> <tr><td>7:</td><td>8.0</td><td style="text-align: center;">↓</td></tr> <tr><td>8:</td><td>8.8</td><td style="text-align: center;">↗</td></tr> <tr><td>9:</td><td>10.3</td><td style="text-align: center;">↗</td></tr> <tr><td>10:</td><td>7.3</td><td style="text-align: center;">↘</td></tr> <tr><td colspan="2">Series</td><td style="text-align: right;">84 (1x)</td></tr> <tr><td colspan="2"></td><td style="text-align: right;">250 (1x)</td></tr> </table>	1:	9.7	↓	2:	10.1	↓	3:	9.6	↙	4:	10.7x	↓	5:	6.6	↑	6:	7.6	↘	7:	8.0	↓	8:	8.8	↗	9:	10.3	↗	10:	7.3	↘	Series		84 (1x)			250 (1x)
1:	9.7	↓																																			
2:	10.1	↓																																			
3:	9.6	↙																																			
4:	10.7x	↓																																			
5:	6.6	↑																																			
6:	7.6	↘																																			
7:	8.0	↓																																			
8:	8.8	↗																																			
9:	10.3	↗																																			
10:	7.3	↘																																			
Series		84 (1x)																																			
		250 (1x)																																			

Relay 2	Lane 21	Stefan Nielsen
-------------------	-------------------	-----------------------

Mix Team Pistol Qual	DEN 7	Mp	P
----------------------	-------	----	---

11.02.2026	Denmark Open Air 2026	Denmark Open Air 2026
------------	-----------------------	-----------------------

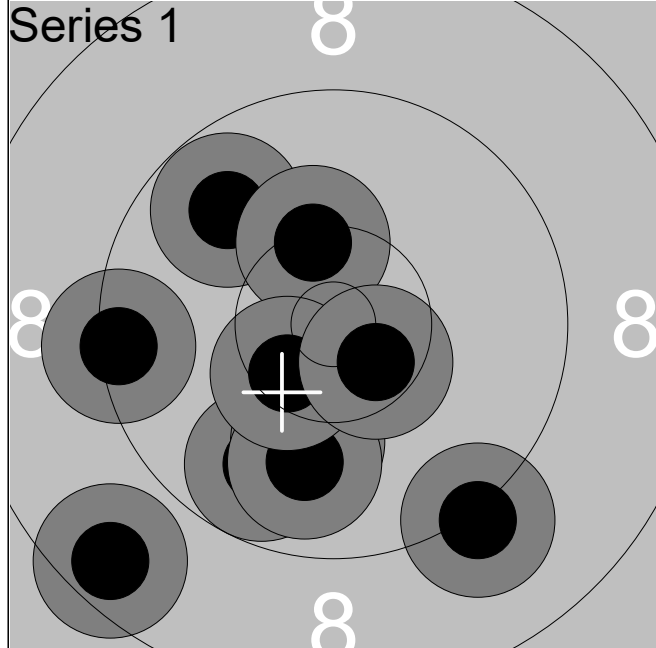

1:	9.8	↗
2:	9.8	↓
3:	10.1	↓
4:	8.6	↙
5:	9.9	↓
6:	9.4	←
7:	10.3	↑
8:	9.2	↓
9:	10.5x	↙
10:	10.5x	↓
Series		93 (2x)
		93 (2x)

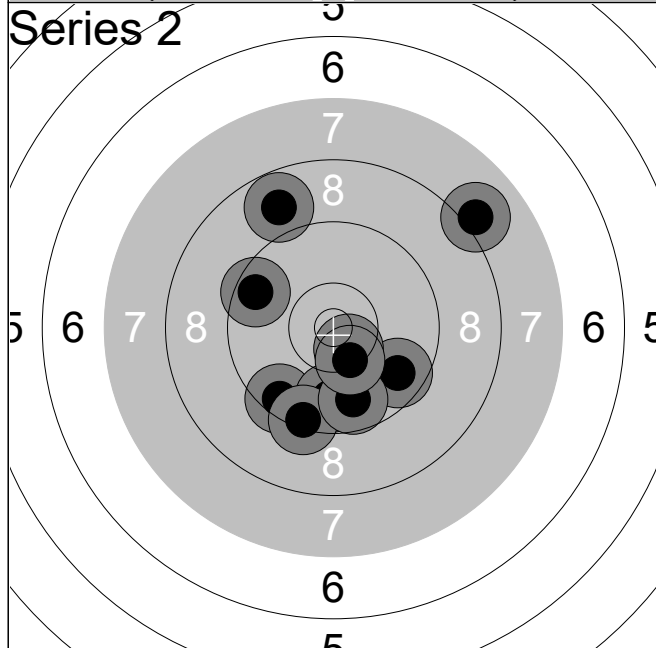

1:	9.7	↘
2:	9.5	↙
3:	10.5x	↓
4:	8.0	↗
5:	9.8	↓
6:	9.4	↓
7:	9.7	↓
8:	9.6	↖
9:	10.4	↓
10:	8.8	↑
Series		90 (1x)
		183 (3x)

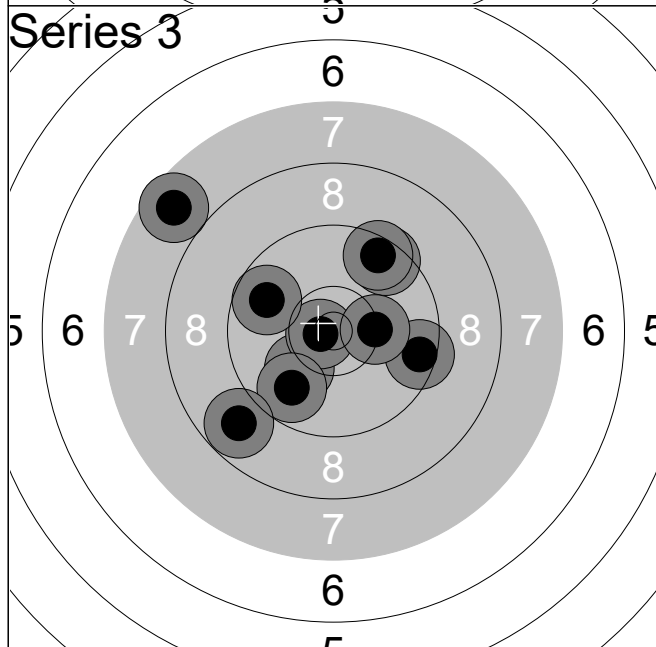

1:	9.5	↗
2:	7.7	↖
3:	10.1	↙
4:	10.7x	←
5:	9.5	→
6:	10.3	→
7:	9.8	↓
8:	9.5	↑
9:	8.8	↙
10:	9.8	↖
Series		90 (1x)
		273 (4x)

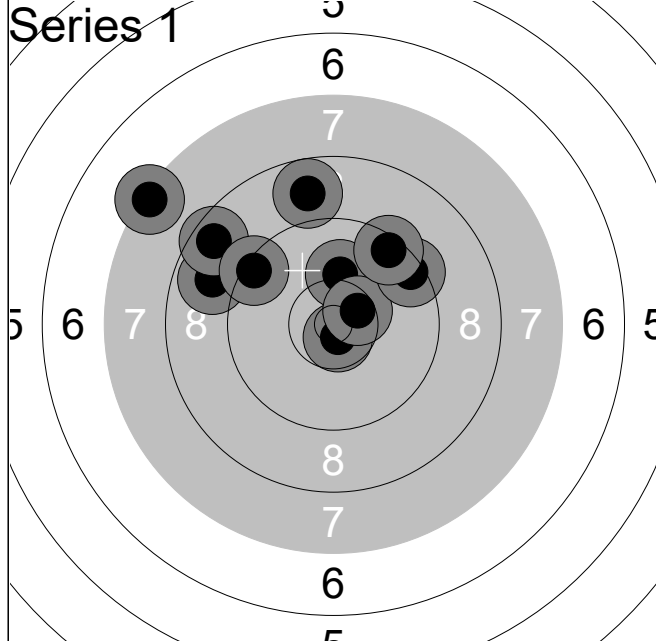

1:	8.9	↖
2:	7.4	↗
3:	10.1	↑
4:	10.7x	↓
5:	10.5x	↘
6:	8.6	↖
7:	8.8	↑
8:	9.4	↖
9:	9.4	↘
10:	9.5	↗

Series	88 (2x)
88 (2x)	

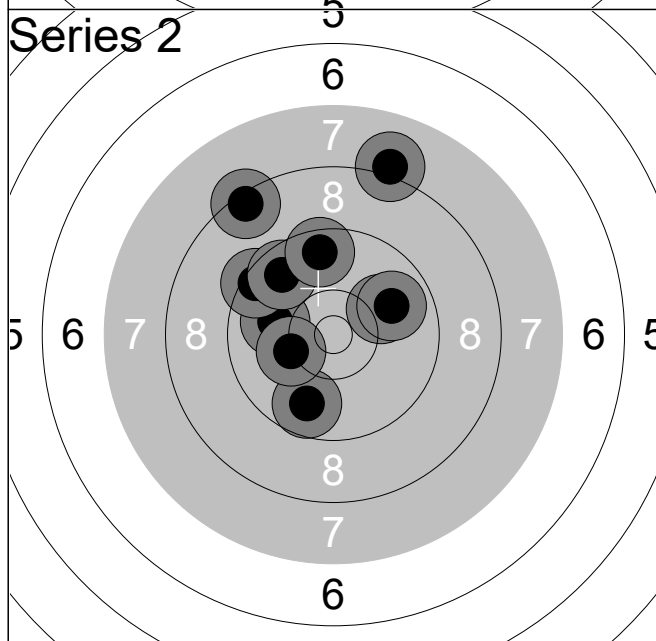

1:	10.0	↖
2:	9.4	↖
3:	10.1	↘
4:	9.8	↓
5:	10.2	↖
6:	9.9	↘
7:	9.7	↖
8:	9.6	↑
9:	8.4	↖
10:	8.1	↑

Series	91 (0x)
179 (2x)	

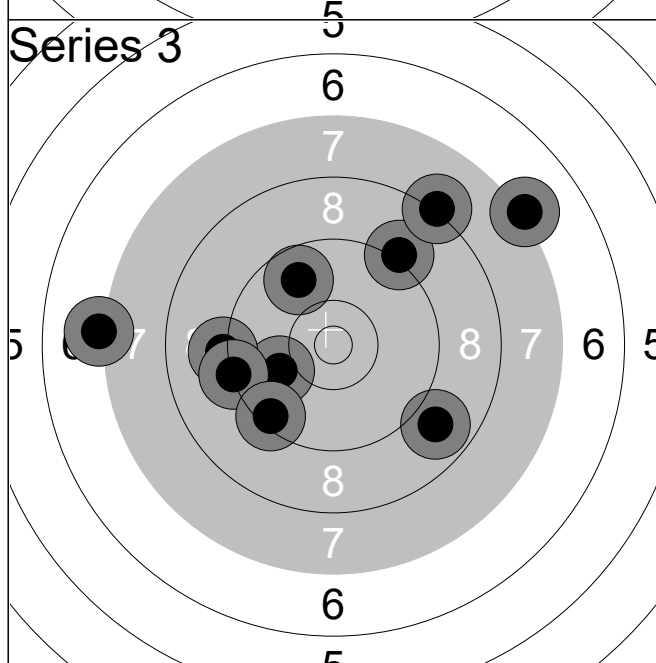

1:	9.1	↗
2:	10.0	↖
3:	8.2	↗
4:	7.1	↖
5:	8.9	↓
6:	9.8	↑
7:	7.2	↘
8:	9.2	↖
9:	9.3	↖
10:	9.4	↓

Series	85 (0x)
264 (2x)	

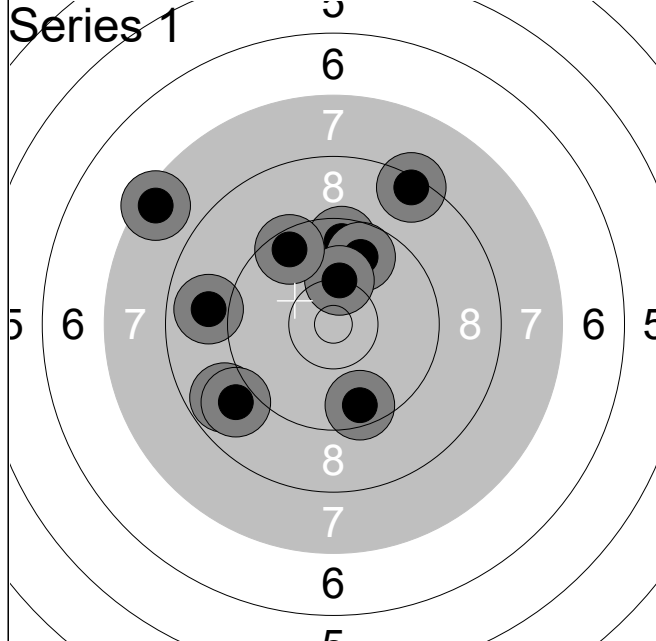

1:	9.6	↑
2:	7.5	↖
3:	9.6	↓
4:	9.8	↑
5:	8.8	↖
6:	8.4	↗
7:	8.9	↖
8:	10.2	↑
9:	9.5	↗
10:	8.9	←
Series		85 (0x)
		85 (0x)

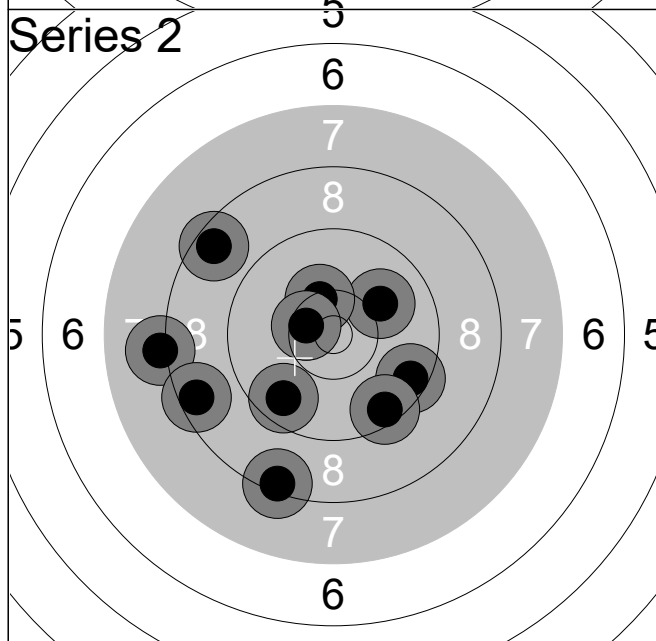

1:	10.0	↗
2:	9.5	↘
3:	8.1	←
4:	10.3	↑
5:	8.5	↗
6:	8.4	↓
7:	9.6	↘
8:	8.5	↖
9:	9.5	↘
10:	10.5x	←
Series		89 (1x)
		174 (1x)

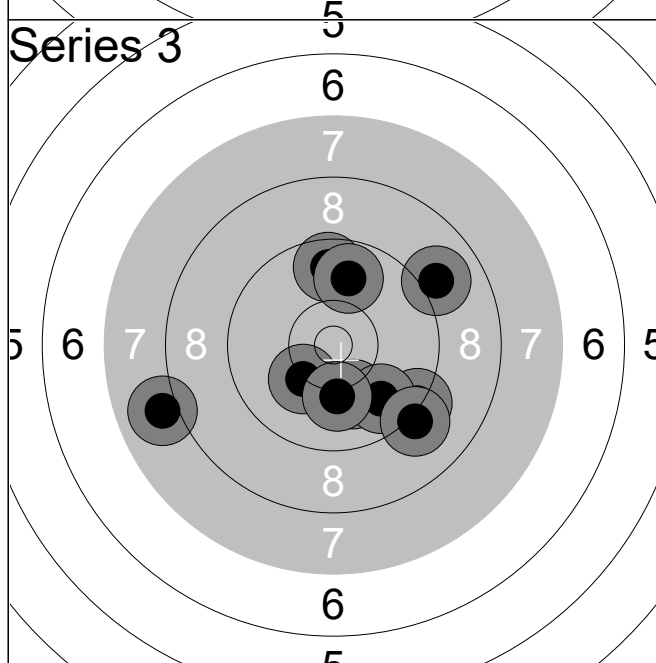

1:	9.3	↘
2:	8.0	↖
3:	10.1	↓
4:	9.8	↘
5:	10.2	↘
6:	9.7	↑
7:	9.1	↘
8:	9.0	↗
9:	9.9	↑
10:	10.1	↓
Series		92 (0x)
		266 (1x)

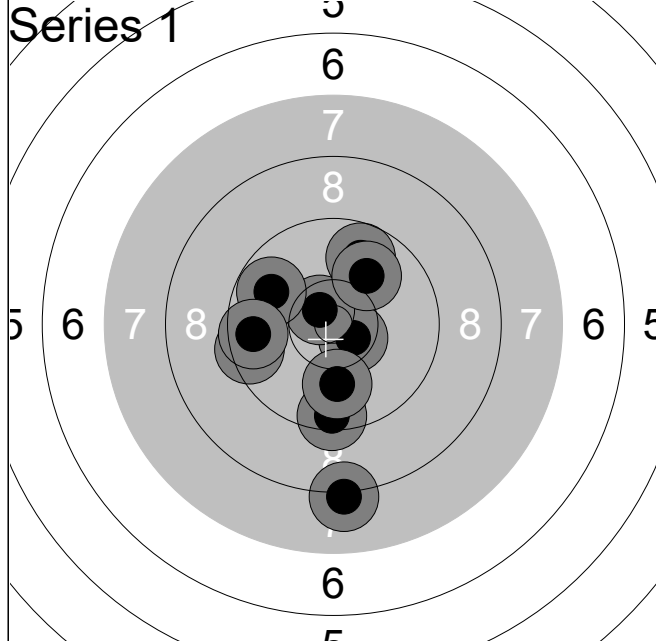

1:	10.6x	↘
2:	10.6x	↗
3:	9.8	↗
4:	9.5	←
5:	8.2	↓
6:	9.5	↓
7:	9.8	↖
8:	10.0	↓
9:	10.0	↗
10:	9.6	←

Series	93 (2x)
93 (2x)	

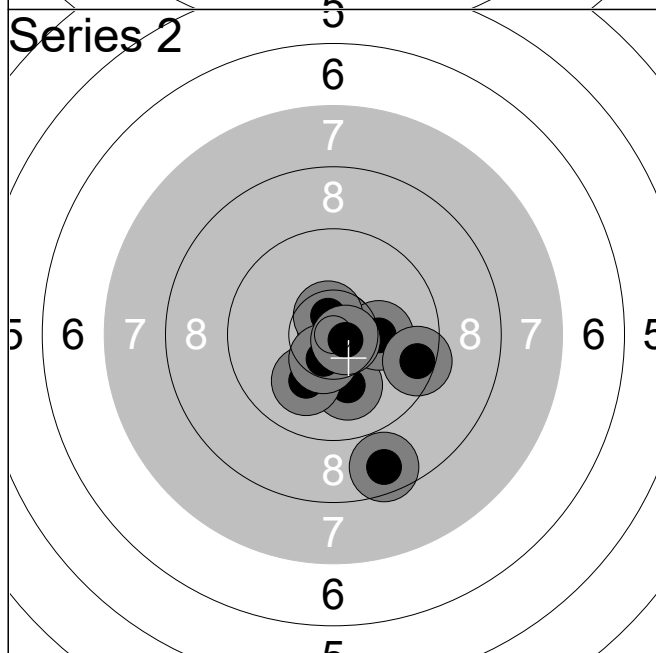

1:	10.8x	↗
2:	10.1	↓
3:	8.6	↓
4:	10.9x	←
5:	10.2	→
6:	10.1	↓
7:	10.6x	↗
8:	10.5x	↓
9:	9.5	→
10:	10.7x	→

Series	97 (5x)
190 (7x)	

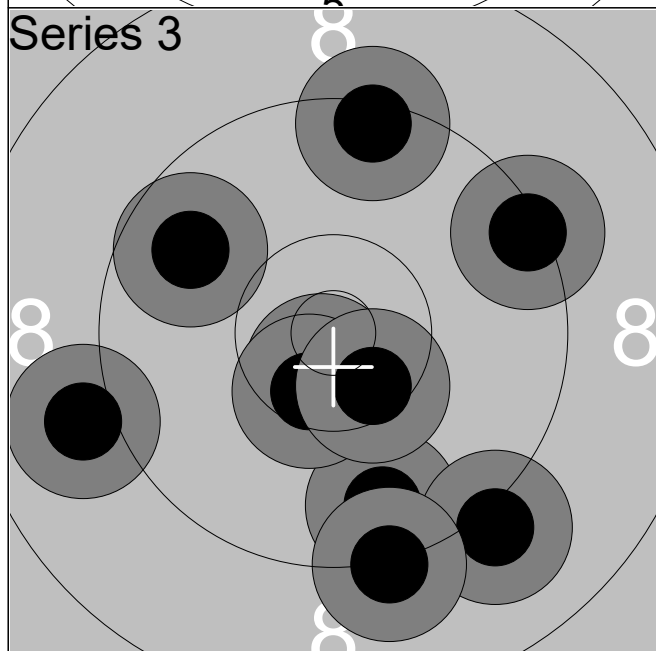

1:	9.0	←
2:	9.3	↗
3:	9.6	↓
4:	9.7	↖
5:	9.1	↓
6:	10.7x	↓
7:	9.4	↗
8:	9.2	↓
9:	10.5x	↓
10:	10.5x	↓

Series	93 (3x)
283 (10x)	

Relay 2	Lane 25	Christian Reitz
-------------------	-------------------	------------------------

Mix Team Pistol Qual	GER 1	Mp	P
----------------------	-------	----	---

11.02.2026	Denmark Open Air 2026	Denmark Open Air 2026
------------	-----------------------	-----------------------

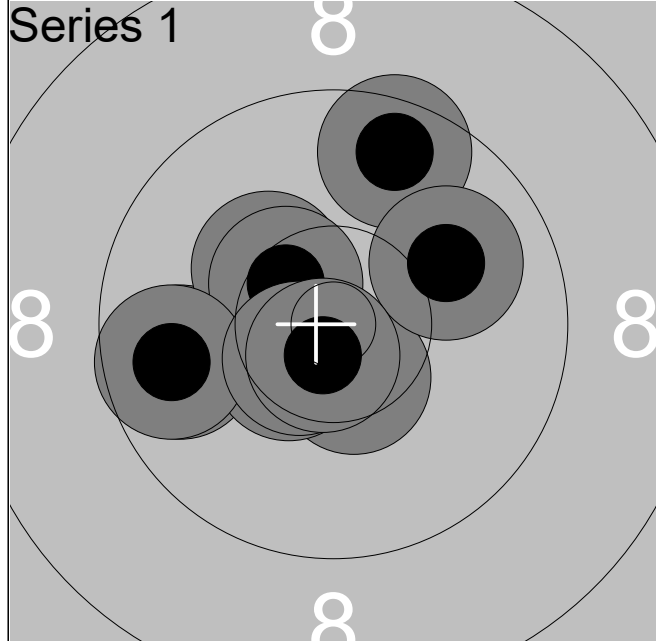

1:	9.8	←
2:	10.5x	↓
3:	9.6	↑
4:	10.5x	↙
5:	10.0	↗
6:	10.3	↖
7:	10.5x	↗
8:	9.7	←
9:	10.6x	↙
10:	10.7x	↓

Series	97 (5x)
	97 (5x)

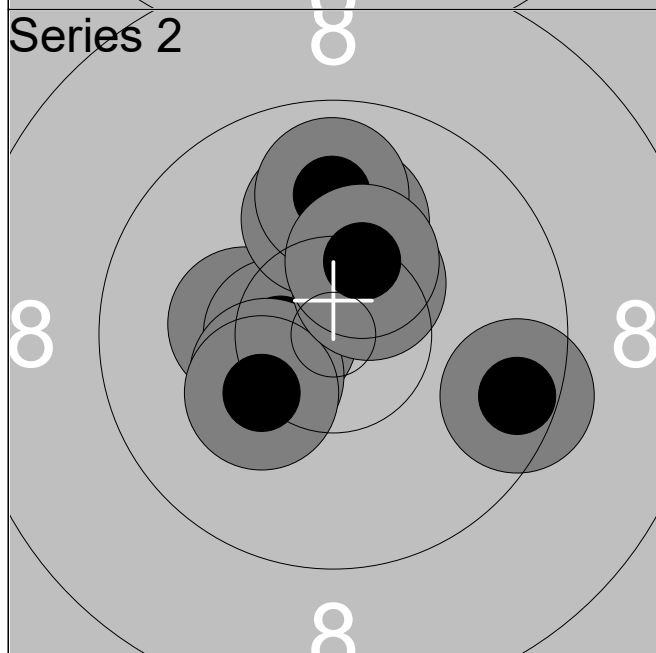

1:	10.3	←
2:	10.6x	←
3:	10.1	↑
4:	10.1	↑
5:	10.4x	↙
6:	10.3	↙
7:	9.9	↑
8:	10.5x	↗
9:	9.5	→
10:	10.4x	↑

Series	98 (4x)
	195 (9x)

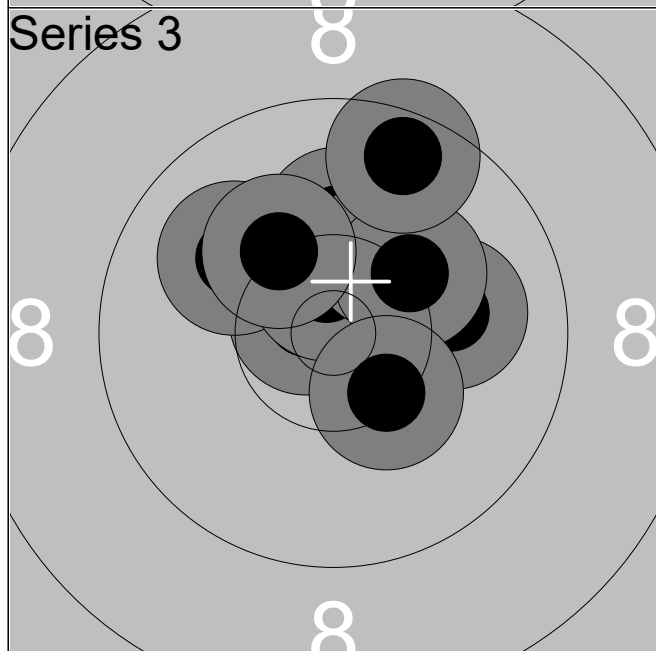

1:	10.7x	↖
2:	10.0	↖
3:	10.1	↑
4:	10.1	→
5:	10.6x	↑
6:	10.3	↗
7:	10.2	↗
8:	9.6	↑
9:	10.4x	↓
10:	10.2	↖

Series	99 (3x)
	294 (12x)

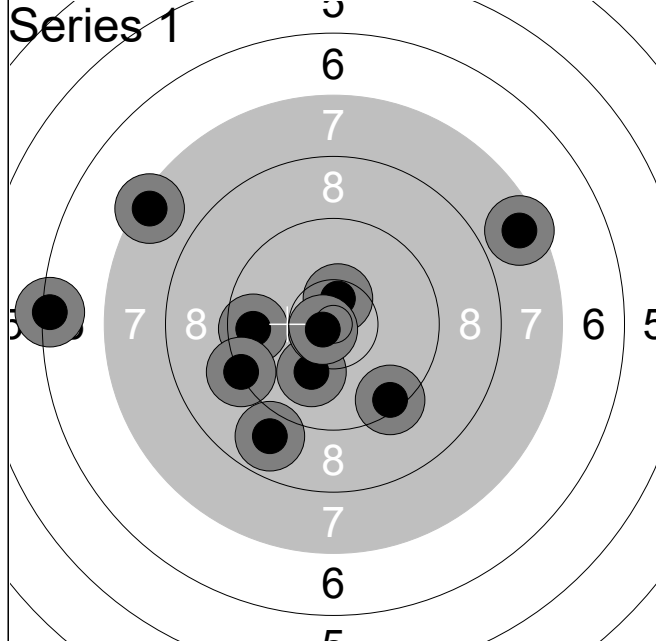

1:	7.4	↖
2:	9.6	←
3:	7.6	↗
4:	10.1	↓
5:	9.3	←
6:	10.5x	↑
7:	6.3	←
8:	9.4	↓
9:	10.8x	↙
10:	8.9	↓
Series		85 (2x)
		85 (2x)

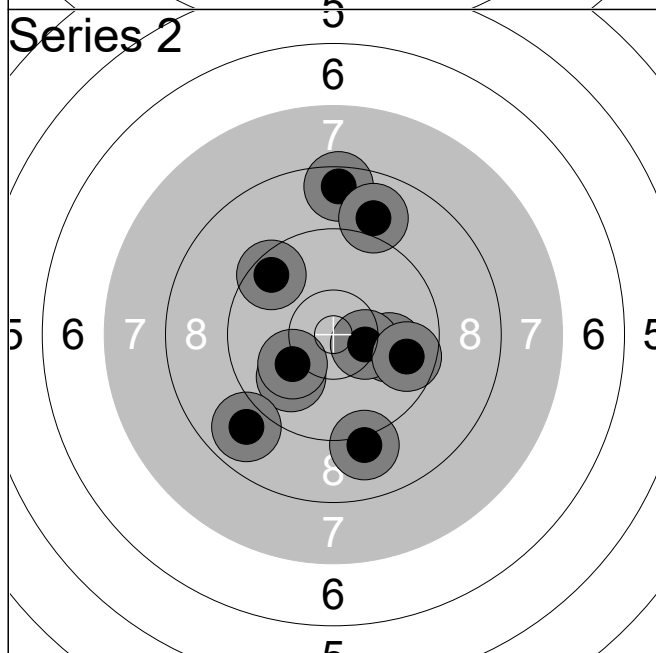

1:	8.6	↑
2:	10.0	↙
3:	8.9	↙
4:	10.0	→
5:	9.0	↑
6:	9.6	↗
7:	10.4x	→
8:	9.7	→
9:	10.1	↙
10:	9.1	↓
Series		92 (1x)
		177 (3x)

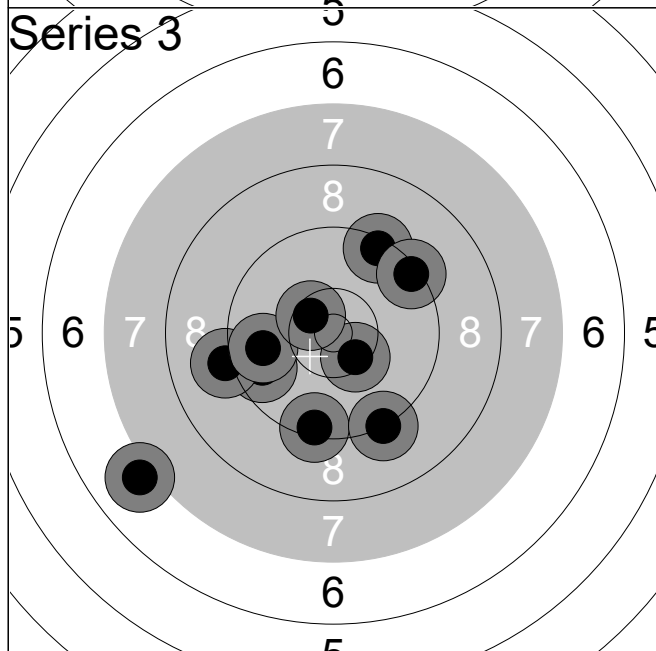

1:	10.4x	↘
2:	9.7	←
3:	9.4	↓
4:	9.4	↗
5:	9.2	↓
6:	9.1	←
7:	9.4	↗
8:	9.8	←
9:	7.0	↙
10:	10.5x	↖
Series		90 (2x)
		267 (5x)

11.02.2026	Denmark Open Air 2026	Denmark Open Air 2026
Series 1 	1: 9.8	➔
	2: 10.3	↗
	3: 9.4	↑
	4: 8.4	↖
	5: 10.7x	←
	6: 8.8	←
	7: 8.3	➔
	8: 10.5x	←
	9: 9.5	↗
	10: 8.4	←
	Series	89 (2x)
		89 (2x)
Series 2 	1: 10.1	↗
	2: 9.9	↑
	3: 9.2	↓
	4: 9.6	➔
	5: 9.9	↗
	6: 7.6	↗
	7: 9.8	↑
	8: 9.0	↓
	9: 9.3	↘
	10: 10.1	←
	Series	90 (0x)
		179 (2x)
Series 3 	1: 2.6	↑
	2: 7.8	↗
	3: 9.9	↗
	4: 8.5	↑
	5: 9.4	↗
	6: 8.9	↖
	7: 8.4	↖
	8: 8.8	↘
	9: 9.2	←
	10: 9.9	←
	Series	77 (0x)
		256 (2x)

11.02.2026	Denmark Open Air 2026	Denmark Open Air 2026
------------	-----------------------	-----------------------

<p>Series 1</p>	<table style="width:100%; border-collapse: collapse;"> <tr><td style="width:10%;">1:</td><td style="width:30%;">7.5</td><td style="width:10%; text-align: center;">↘</td></tr> <tr><td>2:</td><td>8.9</td><td style="text-align: center;">↓</td></tr> <tr><td>3:</td><td>9.8</td><td style="text-align: center;">→</td></tr> <tr><td>4:</td><td>10.1</td><td style="text-align: center;">←</td></tr> <tr><td>5:</td><td>8.5</td><td style="text-align: center;">↓</td></tr> <tr><td>6:</td><td>9.2</td><td style="text-align: center;">↗</td></tr> <tr><td>7:</td><td>9.8</td><td style="text-align: center;">↗</td></tr> <tr><td>8:</td><td>8.8</td><td style="text-align: center;">↘</td></tr> <tr><td>9:</td><td>7.8</td><td style="text-align: center;">↓</td></tr> <tr><td>10:</td><td>9.4</td><td style="text-align: center;">↘</td></tr> <tr><td colspan="2">Series</td><td style="text-align: right;">84 (0x)</td></tr> <tr><td colspan="2"></td><td style="text-align: right;">84 (0x)</td></tr> </table>	1:	7.5	↘	2:	8.9	↓	3:	9.8	→	4:	10.1	←	5:	8.5	↓	6:	9.2	↗	7:	9.8	↗	8:	8.8	↘	9:	7.8	↓	10:	9.4	↘	Series		84 (0x)			84 (0x)
1:	7.5	↘																																			
2:	8.9	↓																																			
3:	9.8	→																																			
4:	10.1	←																																			
5:	8.5	↓																																			
6:	9.2	↗																																			
7:	9.8	↗																																			
8:	8.8	↘																																			
9:	7.8	↓																																			
10:	9.4	↘																																			
Series		84 (0x)																																			
		84 (0x)																																			
<p>Series 2</p>	<table style="width:100%; border-collapse: collapse;"> <tr><td style="width:10%;">1:</td><td style="width:30%;">9.2</td><td style="width:10%; text-align: center;">↘</td></tr> <tr><td>2:</td><td>9.4</td><td style="text-align: center;">↘</td></tr> <tr><td>3:</td><td>9.4</td><td style="text-align: center;">↓</td></tr> <tr><td>4:</td><td>10.0</td><td style="text-align: center;">↘</td></tr> <tr><td>5:</td><td>10.0</td><td style="text-align: center;">↘</td></tr> <tr><td>6:</td><td>10.1</td><td style="text-align: center;">↗</td></tr> <tr><td>7:</td><td>8.9</td><td style="text-align: center;">←</td></tr> <tr><td>8:</td><td>9.2</td><td style="text-align: center;">↓</td></tr> <tr><td>9:</td><td>9.5</td><td style="text-align: center;">→</td></tr> <tr><td>10:</td><td>9.0</td><td style="text-align: center;">↓</td></tr> <tr><td colspan="2">Series</td><td style="text-align: right;">92 (0x)</td></tr> <tr><td colspan="2"></td><td style="text-align: right;">176 (0x)</td></tr> </table>	1:	9.2	↘	2:	9.4	↘	3:	9.4	↓	4:	10.0	↘	5:	10.0	↘	6:	10.1	↗	7:	8.9	←	8:	9.2	↓	9:	9.5	→	10:	9.0	↓	Series		92 (0x)			176 (0x)
1:	9.2	↘																																			
2:	9.4	↘																																			
3:	9.4	↓																																			
4:	10.0	↘																																			
5:	10.0	↘																																			
6:	10.1	↗																																			
7:	8.9	←																																			
8:	9.2	↓																																			
9:	9.5	→																																			
10:	9.0	↓																																			
Series		92 (0x)																																			
		176 (0x)																																			
<p>Series 3</p>	<table style="width:100%; border-collapse: collapse;"> <tr><td style="width:10%;">1:</td><td style="width:30%;">10.6x</td><td style="width:10%; text-align: center;">→</td></tr> <tr><td>2:</td><td>10.0</td><td style="text-align: center;">↗</td></tr> <tr><td>3:</td><td>8.9</td><td style="text-align: center;">←</td></tr> <tr><td>4:</td><td>9.6</td><td style="text-align: center;">↑</td></tr> <tr><td>5:</td><td>9.6</td><td style="text-align: center;">↘</td></tr> <tr><td>6:</td><td>8.1</td><td style="text-align: center;">↗</td></tr> <tr><td>7:</td><td>8.3</td><td style="text-align: center;">↗</td></tr> <tr><td>8:</td><td>9.5</td><td style="text-align: center;">↑</td></tr> <tr><td>9:</td><td>7.7</td><td style="text-align: center;">↘</td></tr> <tr><td>10:</td><td>9.7</td><td style="text-align: center;">←</td></tr> <tr><td colspan="2">Series</td><td style="text-align: right;">87 (1x)</td></tr> <tr><td colspan="2"></td><td style="text-align: right;">263 (1x)</td></tr> </table>	1:	10.6x	→	2:	10.0	↗	3:	8.9	←	4:	9.6	↑	5:	9.6	↘	6:	8.1	↗	7:	8.3	↗	8:	9.5	↑	9:	7.7	↘	10:	9.7	←	Series		87 (1x)			263 (1x)
1:	10.6x	→																																			
2:	10.0	↗																																			
3:	8.9	←																																			
4:	9.6	↑																																			
5:	9.6	↘																																			
6:	8.1	↗																																			
7:	8.3	↗																																			
8:	9.5	↑																																			
9:	7.7	↘																																			
10:	9.7	←																																			
Series		87 (1x)																																			
		263 (1x)																																			

11.02.2026	Denmark Open Air 2026	Denmark Open Air 2026
Series 1 	1: 9.1	↓
	2: 8.6	↓
	3: 8.6	↓
	4: 9.5	↗
	5: 8.7	→
	6: 8.9	←
	7: 7.5	←
	8: 9.5	←
	9: 8.6	↖
	10: 7.7	←
	Series	81 (0x)
81 (0x)		
Series 2 	1: 9.4	↖
	2: 9.9	↖
	3: 9.6	←
	4: 7.5	↖
	5: 9.3	←
	6: 8.8	↓
	7: 10.3	←
	8: 10.5x	→
	9: 10.2	↓
	10: 9.4	→
	Series	90 (1x)
171 (1x)		
Series 3 	1: 9.3	↘
	2: 10.6x	←
	3: 8.1	↗
	4: 10.1	↗
	5: 10.1	↓
	6: 9.6	↘
	7: 9.4	→
	8: 10.4x	↓
	9: 8.1	↓
	10: 8.9	↓
	Series	91 (2x)
262 (3x)		

11.02.2026	Denmark Open Air 2026	Denmark Open Air 2026
------------	-----------------------	-----------------------

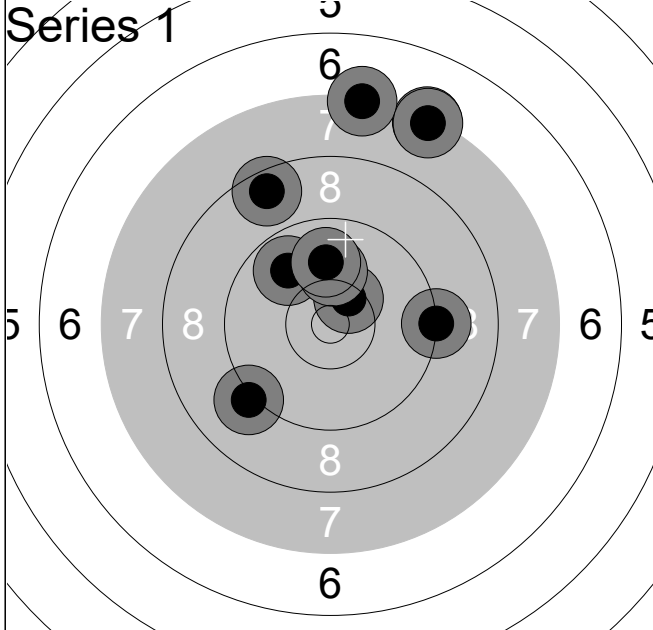
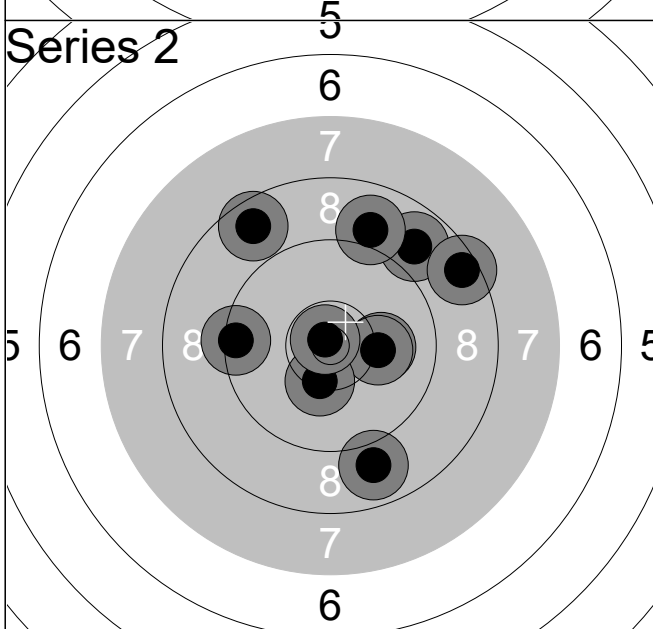
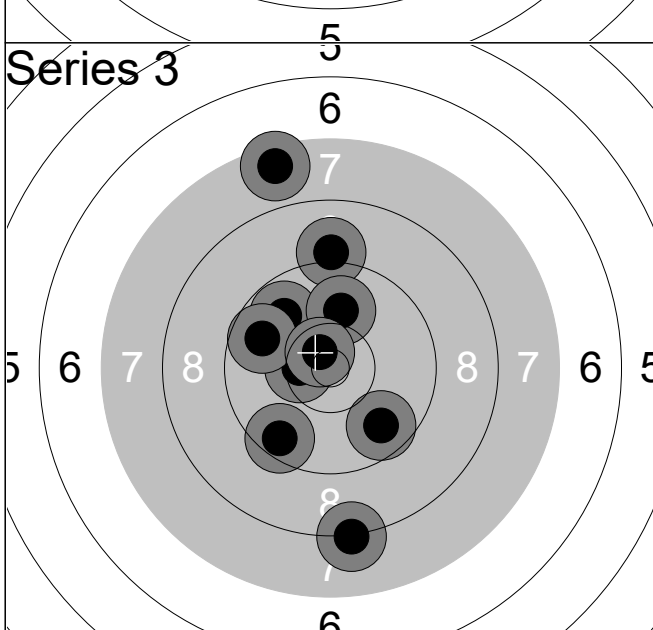
Series 1 	<table style="width:100%; border-collapse: collapse;"> <tr><td style="width:10%;">1:</td><td style="width:60%;">7.3</td><td style="width:10%; text-align: center;">↗</td></tr> <tr><td>2:</td><td>7.3</td><td style="text-align: center;">↑</td></tr> <tr><td>3:</td><td>9.2</td><td style="text-align: center;">↙</td></tr> <tr><td>4:</td><td>8.6</td><td style="text-align: center;">↖</td></tr> <tr><td>5:</td><td>10.4x</td><td style="text-align: center;">↗</td></tr> <tr><td>6:</td><td>9.8</td><td style="text-align: center;">↖</td></tr> <tr><td>7:</td><td>9.2</td><td style="text-align: center;">→</td></tr> <tr><td>8:</td><td>10.1</td><td style="text-align: center;">↑</td></tr> <tr><td>9:</td><td>9.9</td><td style="text-align: center;">↑</td></tr> <tr><td>10:</td><td>7.3</td><td style="text-align: center;">↗</td></tr> <tr><td colspan="2">Series</td><td style="text-align: right;">85 (1x)</td></tr> <tr><td colspan="2"></td><td style="text-align: right;">85 (1x)</td></tr> </table>	1:	7.3	↗	2:	7.3	↑	3:	9.2	↙	4:	8.6	↖	5:	10.4x	↗	6:	9.8	↖	7:	9.2	→	8:	10.1	↑	9:	9.9	↑	10:	7.3	↗	Series		85 (1x)			85 (1x)
1:	7.3	↗																																			
2:	7.3	↑																																			
3:	9.2	↙																																			
4:	8.6	↖																																			
5:	10.4x	↗																																			
6:	9.8	↖																																			
7:	9.2	→																																			
8:	10.1	↑																																			
9:	9.9	↑																																			
10:	7.3	↗																																			
Series		85 (1x)																																			
		85 (1x)																																			
Series 2 	<table style="width:100%; border-collapse: collapse;"> <tr><td style="width:10%;">1:</td><td style="width:60%;">8.8</td><td style="width:10%; text-align: center;">↗</td></tr> <tr><td>2:</td><td>9.0</td><td style="text-align: center;">↑</td></tr> <tr><td>3:</td><td>10.1</td><td style="text-align: center;">→</td></tr> <tr><td>4:</td><td>8.5</td><td style="text-align: center;">↗</td></tr> <tr><td>5:</td><td>8.7</td><td style="text-align: center;">↖</td></tr> <tr><td>6:</td><td>10.2</td><td style="text-align: center;">→</td></tr> <tr><td>7:</td><td>9.4</td><td style="text-align: center;">←</td></tr> <tr><td>8:</td><td>8.9</td><td style="text-align: center;">↓</td></tr> <tr><td>9:</td><td>10.4</td><td style="text-align: center;">↓</td></tr> <tr><td>10:</td><td>10.8x</td><td style="text-align: center;">↖</td></tr> <tr><td colspan="2">Series</td><td style="text-align: right;">90 (1x)</td></tr> <tr><td colspan="2"></td><td style="text-align: right;">175 (2x)</td></tr> </table>	1:	8.8	↗	2:	9.0	↑	3:	10.1	→	4:	8.5	↗	5:	8.7	↖	6:	10.2	→	7:	9.4	←	8:	8.9	↓	9:	10.4	↓	10:	10.8x	↖	Series		90 (1x)			175 (2x)
1:	8.8	↗																																			
2:	9.0	↑																																			
3:	10.1	→																																			
4:	8.5	↗																																			
5:	8.7	↖																																			
6:	10.2	→																																			
7:	9.4	←																																			
8:	8.9	↓																																			
9:	10.4	↓																																			
10:	10.8x	↖																																			
Series		90 (1x)																																			
		175 (2x)																																			
Series 3 	<table style="width:100%; border-collapse: collapse;"> <tr><td style="width:10%;">1:</td><td style="width:60%;">10.5x</td><td style="width:10%; text-align: center;">←</td></tr> <tr><td>2:</td><td>9.5</td><td style="text-align: center;">↙</td></tr> <tr><td>3:</td><td>8.2</td><td style="text-align: center;">↓</td></tr> <tr><td>4:</td><td>9.7</td><td style="text-align: center;">↙</td></tr> <tr><td>5:</td><td>9.8</td><td style="text-align: center;">↖</td></tr> <tr><td>6:</td><td>9.1</td><td style="text-align: center;">↑</td></tr> <tr><td>7:</td><td>9.8</td><td style="text-align: center;">←</td></tr> <tr><td>8:</td><td>7.5</td><td style="text-align: center;">↑</td></tr> <tr><td>9:</td><td>10.0</td><td style="text-align: center;">↑</td></tr> <tr><td>10:</td><td>10.6x</td><td style="text-align: center;">↖</td></tr> <tr><td colspan="2">Series</td><td style="text-align: right;">90 (2x)</td></tr> <tr><td colspan="2"></td><td style="text-align: right;">265 (4x)</td></tr> </table>	1:	10.5x	←	2:	9.5	↙	3:	8.2	↓	4:	9.7	↙	5:	9.8	↖	6:	9.1	↑	7:	9.8	←	8:	7.5	↑	9:	10.0	↑	10:	10.6x	↖	Series		90 (2x)			265 (4x)
1:	10.5x	←																																			
2:	9.5	↙																																			
3:	8.2	↓																																			
4:	9.7	↙																																			
5:	9.8	↖																																			
6:	9.1	↑																																			
7:	9.8	←																																			
8:	7.5	↑																																			
9:	10.0	↑																																			
10:	10.6x	↖																																			
Series		90 (2x)																																			
		265 (4x)																																			

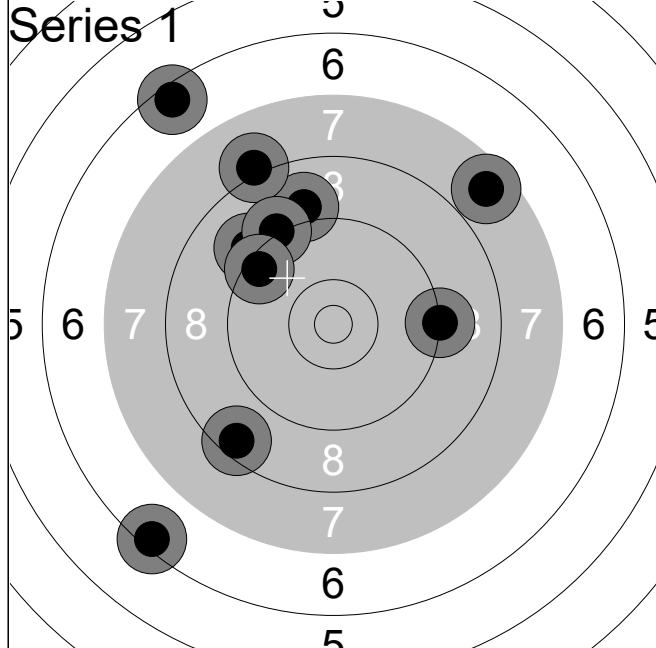

1:	9.1	↗
2:	9.0	↑
3:	6.5	↗
4:	8.1	↗
5:	9.2	→
6:	6.4	↙
7:	9.2	↗
8:	8.5	↙
9:	7.6	↗
10:	9.4	↖
Series		80 (0x)
		80 (0x)

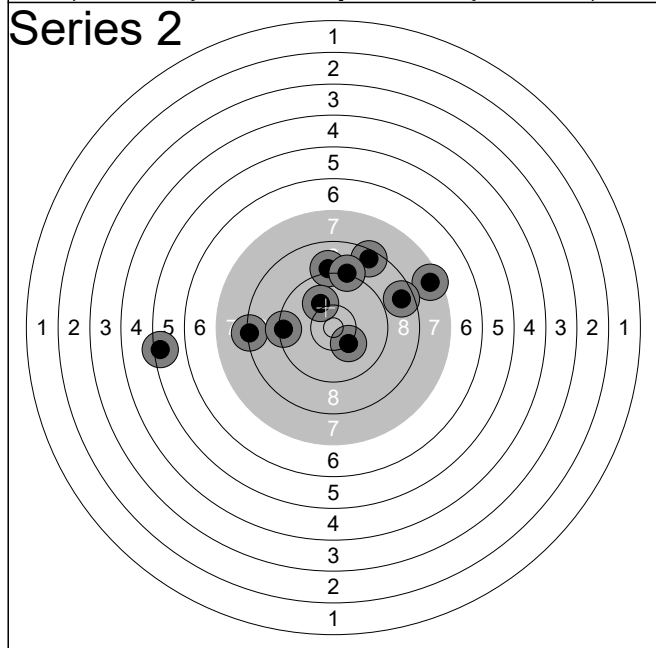

1:	9.1	↑
2:	5.4	←
3:	7.6	↗
4:	10.2	↘
5:	8.6	↗
6:	10.1	↗
7:	8.3	←
8:	8.5	↗
9:	9.4	←
10:	9.2	↑
Series		83 (0x)
		163 (0x)

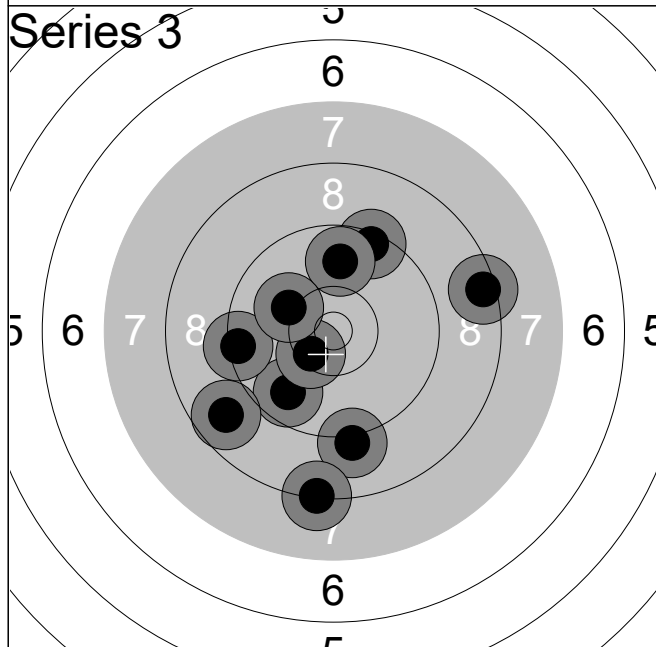

1:	8.4	→
2:	9.1	↓
3:	9.4	↗
4:	9.7	↘
5:	10.4x	↘
6:	9.8	↑
7:	8.3	↓
8:	9.4	←
9:	10.1	↖
10:	8.7	↘
Series		89 (1x)
		252 (1x)

11.02.2026	Denmark Open Air 2026	Denmark Open Air 2026	
Series 1 	1:	10.0	←
	2:	10.3	↗
	3:	9.6	↓
	4:	8.4	↑
	5:	10.1	↘
	6:	8.9	↗
	7:	10.5x	↗
	8:	10.4	↑
	9:	9.7	↓
	10:	10.2	↓
	Series		94 (1x)
		94 (1x)	
Series 2 	1:	8.7	↑
	2:	10.2	↙
	3:	9.9	↙
	4:	9.9	↗
	5:	10.5x	↗
	6:	9.4	↙
	7:	10.4x	↗
	8:	9.8	↑
	9:	9.3	↙
	10:	9.6	↘
	Series		92 (2x)
		186 (3x)	
Series 3 	1:	7.5	↘
	2:	5.8	↙
	3:	5.4	↗
	4:	8.4	→
	5:	6.5	→
	6:	9.4	↙
	7:	8.6	↘
	8:	10.6x	↙
	9:	9.9	↘
	10:	9.0	←
	Series		76 (1x)
		262 (4x)	

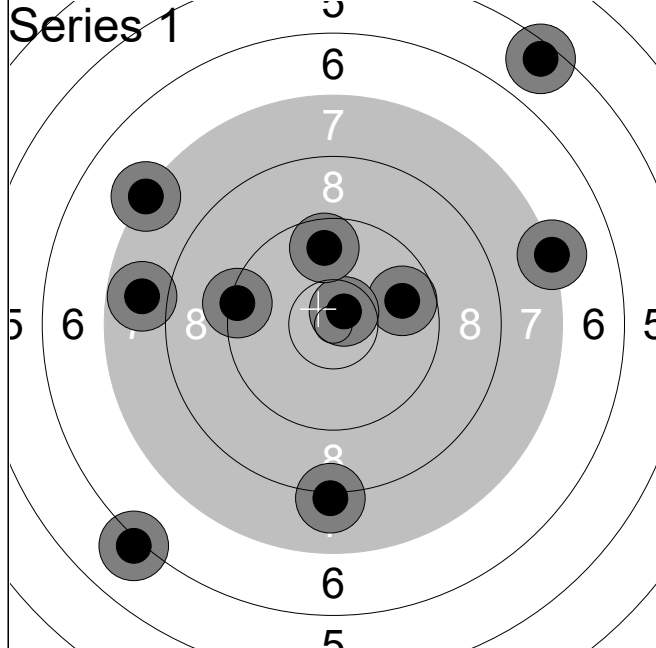

1:	7.8	←
2:	9.8	→
3:	9.3	←
4:	6.1	↓
5:	7.3	↖
6:	10.7x	↗
7:	5.5	↗
8:	9.7	↑
9:	8.1	↓
10:	7.2	→
Series		77 (1x)
		77 (1x)

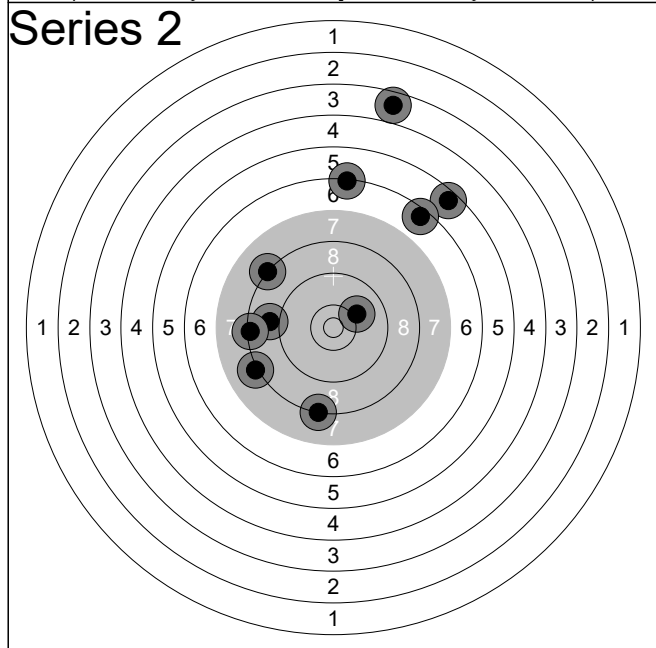

1:	3.7	↑
2:	8.9	←
3:	6.3	↑
4:	10.1	↗
5:	8.2	↖
6:	5.5	↗
7:	8.1	←
8:	6.5	↗
9:	8.3	←
10:	8.2	↓
Series		70 (0x)
		147 (1x)

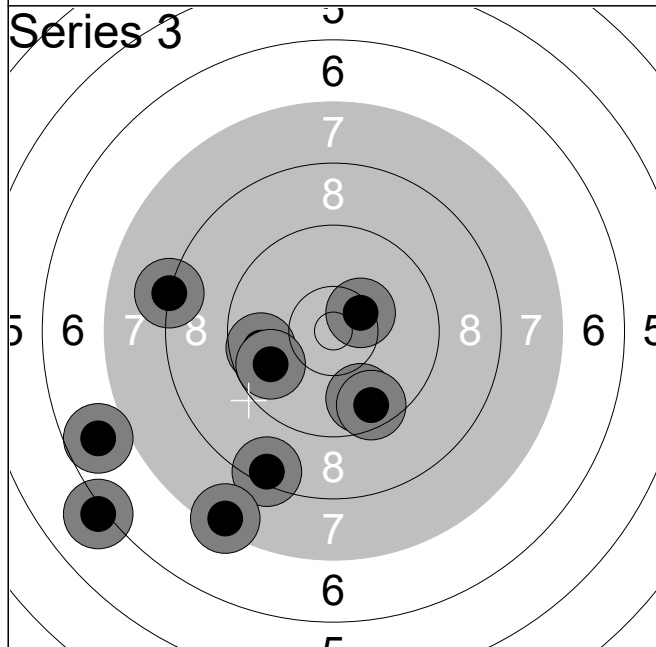

1:	10.4x	↗
2:	6.8	←
3:	8.4	↓
4:	9.7	←
5:	9.8	↓
6:	9.6	↓
7:	6.1	↖
8:	9.8	←
9:	7.4	↓
10:	8.2	←
Series		81 (1x)
		228 (2x)

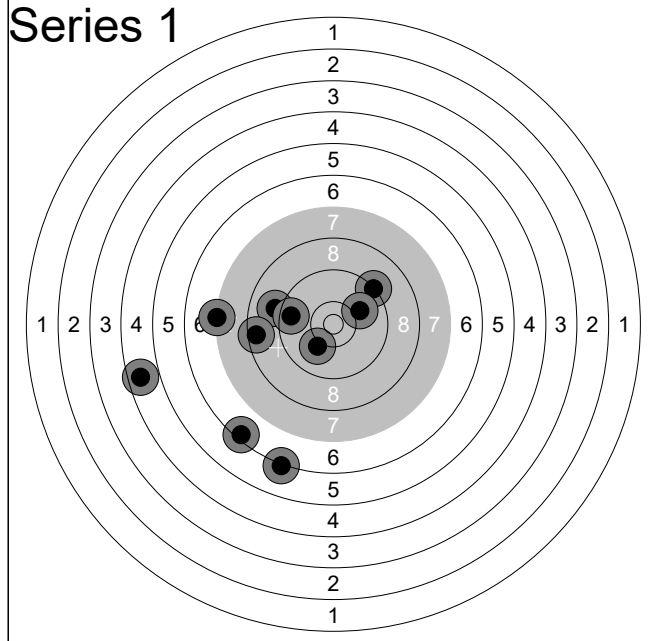

1:	9.0	←
2:	9.3	↗
3:	10.0	↗
4:	6.4	↘
5:	4.6	←
6:	9.6	←
7:	7.2	←
8:	8.5	←
9:	6.2	↘
10:	10.1	↘
Series		78 (0x)
		78 (0x)

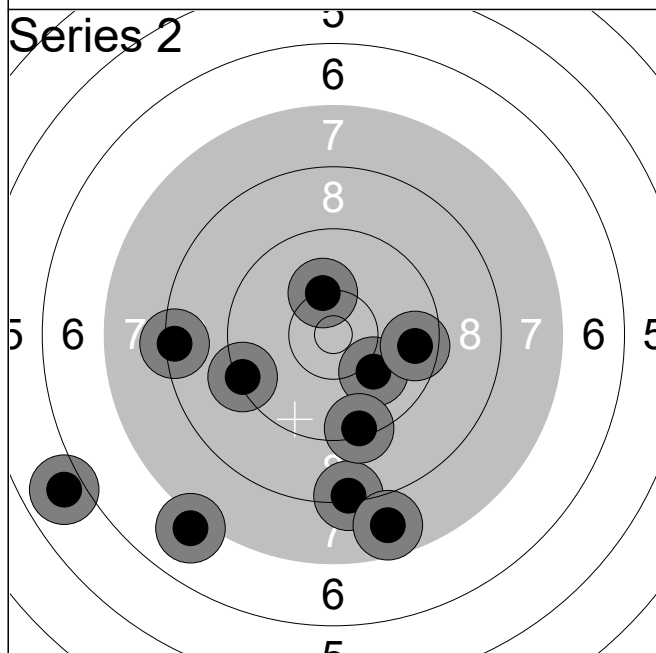

1:	8.3	↓
2:	8.4	←
3:	10.1	↘
4:	9.6	→
5:	9.4	↘
6:	10.3	↑
7:	9.3	←
8:	7.7	↓
9:	5.9	←
10:	7.1	↘
Series		82 (0x)
		160 (0x)

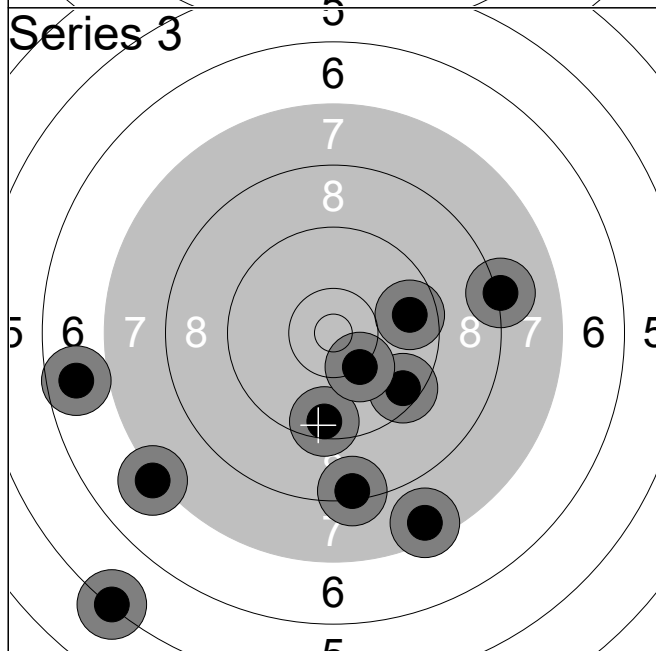

1:	7.2	↙
2:	8.4	↓
3:	8.2	→
4:	9.5	↘
5:	7.5	↘
6:	9.7	→
7:	5.3	↘
8:	9.5	↓
9:	6.7	←
10:	10.3	↘
Series		78 (0x)
		238 (0x)

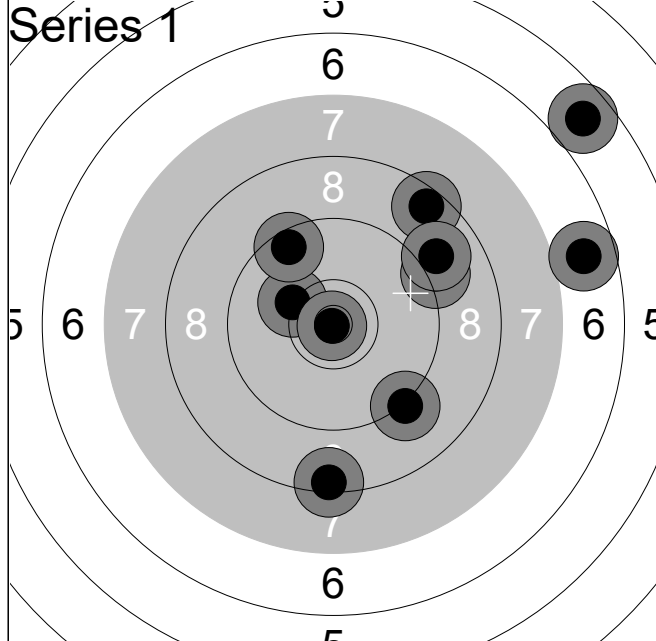

1:	9.1	↗
2:	8.5	↗
3:	5.7	↗
4:	6.7	→
5:	10.2	↖
6:	8.4	↓
7:	9.2	↘
8:	9.5	↗
9:	9.0	↗
10:	10.9x	↙

Series	83 (1x)
	83 (1x)

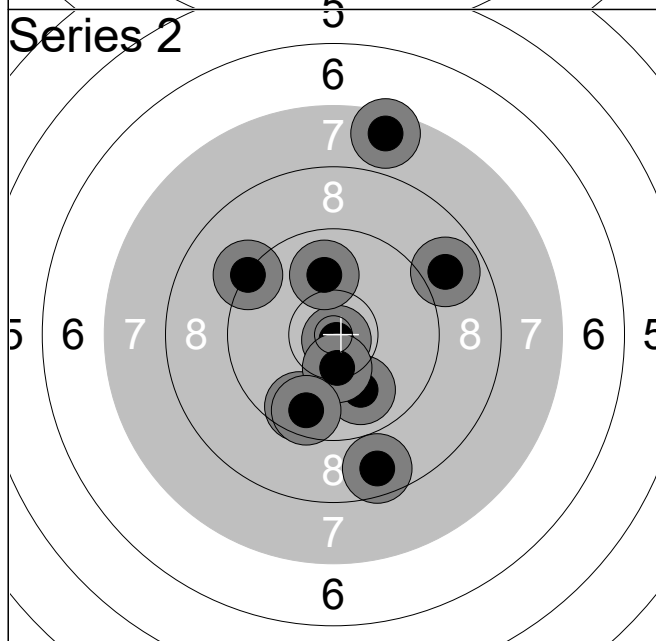

1:	8.7	↓
2:	10.8x	↘
3:	10.0	↑
4:	8.9	↗
5:	7.6	↑
6:	9.9	↘
7:	9.3	↗
8:	9.7	↘
9:	10.4x	↓
10:	9.6	↘

Series	89 (2x)
	172 (3x)

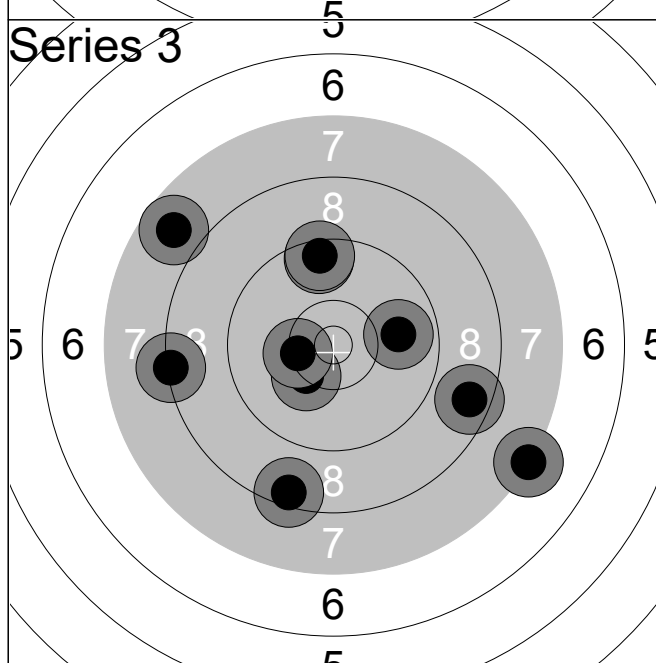

1:	8.5	↓
2:	7.3	↘
3:	7.8	↗
4:	9.5	↑
5:	9.5	↑
6:	8.6	→
7:	9.9	→
8:	10.3	↘
9:	10.4	←
10:	8.3	←

Series	85 (0x)
	257 (3x)